

### General Description

The TGL2767 is a wideband voltage-variable attenuator using Qorvo's production 0.15  $\mu\text{m}$  GaAs pHEMT process (QPHT15). Operating from 2–25GHz, the TGL2767 offers > 20 dB of attenuation range with < 2 dB insertion loss in the reference state. The TGL2767's broadband performance allows it to be a single solution for a number of radar and communication bands; as well as electronic warfare, instrumentation and other general RF-based applications.

The TGL2767 is fully matched to 50 ohms and offered in a small 1.17 x 0.98 mm footprint. This along with using standard control and reference voltages, allows users to integrate the TGL2767 into their system with minimal effort.



### Functional Block Diagram

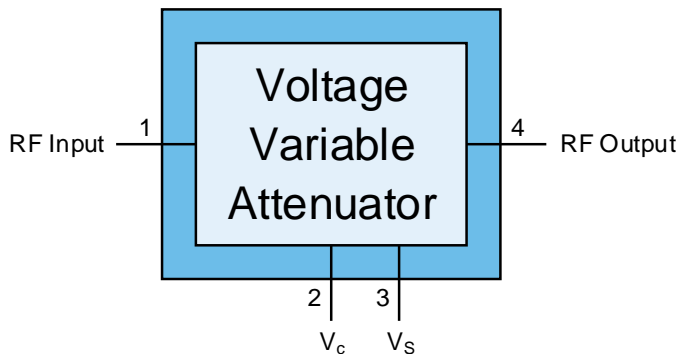

### Product Features

- Frequency Range: 2–25 GHz
- Attenuation Range: 20 dB
- Insertion Loss (Ref. State): < 2 dB
- Control Voltage: 0.0–1.5 V
- Reference Voltage: 1.5 V
- Die Size: 1.17 x 0.98 x 0.10 mm

*Performance is typical across frequency. Please reference electrical specification table and data plots for more details.*

### Applications

- Commercial and Military Radar
- Electronic Warfare
- Satellite Communications
- Point to Point Radio
- Instrumentation
- General Purpose

### Ordering Information

Part No.	Description
TGL2767	2–25 GHz Voltage Variable Attenuator, Gel Pack, 100 pieces
TGL2767 EVB	2–25 GHz Voltage Var. Attenuator Evaluation Board
QPC2767S	2–25 GHz Voltage Var. Attenuator Space Inspected Version, Contact Sales.

## Absolute Maximum Ratings

Parameter	Value/Range
Control Voltage ( $V_C$ , $V_S$ )	$\pm 3.0$ V
Control Current ( $I_C$ , $I_S$ )	3 mA
Input Power ( $P_{IN}$ )	30 dBm
Power Dissipation ( $P_{DISS}$ )	1 W
Mounting Temperature (30 seconds)	320 °C
Operating Channel Temperature	150 °C
Storage Temperature	-55 to 150 °C

Operation of this device outside the parameter ranges given above may cause permanent damage. These are stress ratings only, and functional operation of the device at these conditions is not implied.

## Recommended Operating Conditions

Parameter	Value/Range
Control Voltage ( $V_C$ ); $V_C \leq V_S$	0 – 1.5 V
Reference Voltage <sup>1</sup> ( $V_S$ )	1.5 V
Operating Temperature Range	-40 to +85 °C

Note: <sup>1</sup>  $V_S$  can be adjusted as needed to compensate for the FET threshold variations among wafer/lots.

Electrical specifications are measured at specified test conditions. Specifications are not guaranteed over all recommended operating conditions.

## Electrical Specifications

Test conditions, unless otherwise noted: 25 °C,  $V_C = 0 - 1.5$  V,  $V_S = 1.5$  V;  $V_C \leq V_S$

Parameter	Min	Typical	Max	Units
Frequency Range	2		25	GHz
Attenuation Range		20		dB
Reference State Insertion Loss ( $V_C = 1.5$ V)		<2.0		dB
Input Return Loss		>12		dB
Output Return Loss		>12		dB
IIP3 (10 MHz tone spacing, $P_{IN}/\text{Tone} = 10$ dBm)				
$V_C$ set for 0 dB		>38		dBm
$V_C$ set for 5 dB		>25		dBm
$V_C$ set for 10 dB		>22		dBm
$V_C$ set for 15 dB		>22		dBm
$V_C$ set for 20 dB		>30		dBm

Typical Performance (Small Signal)

Test conditions unless otherwise noted: Temp. = 25 °C,  $V_s = 1.5$  V, tested with DUT mounted to EVB

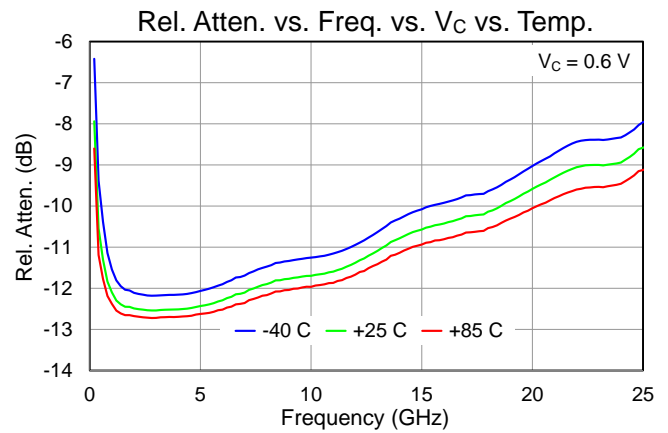
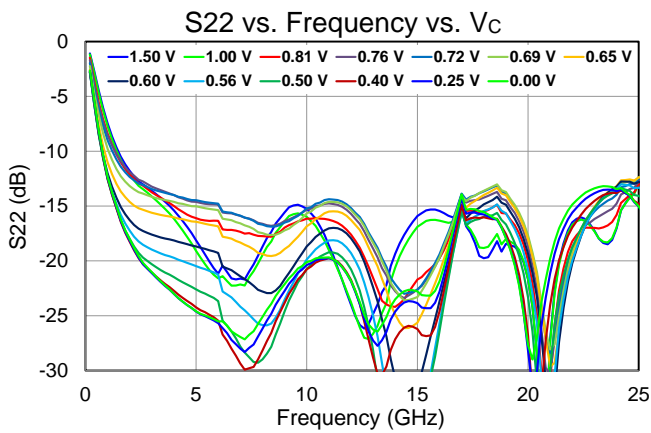
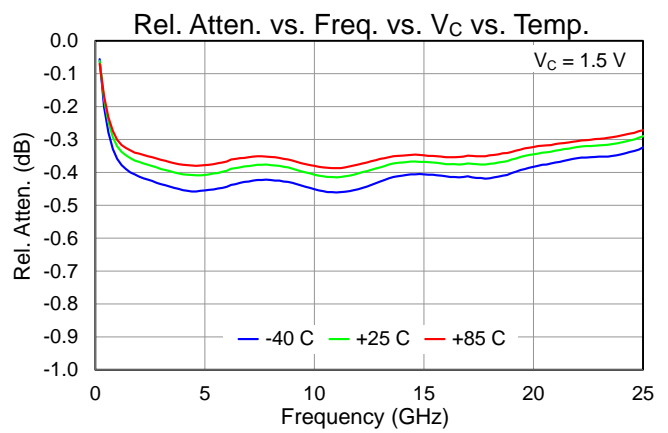
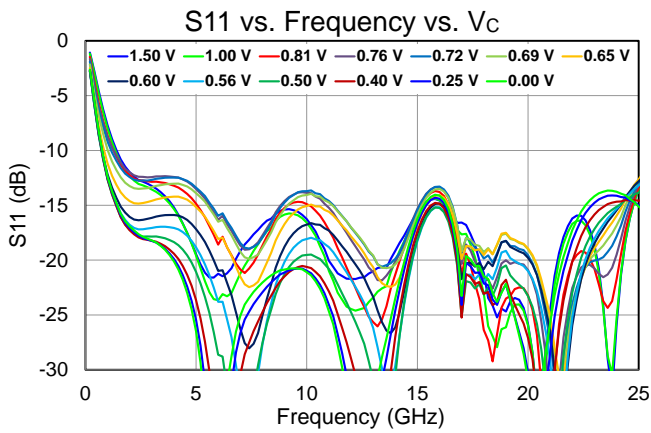
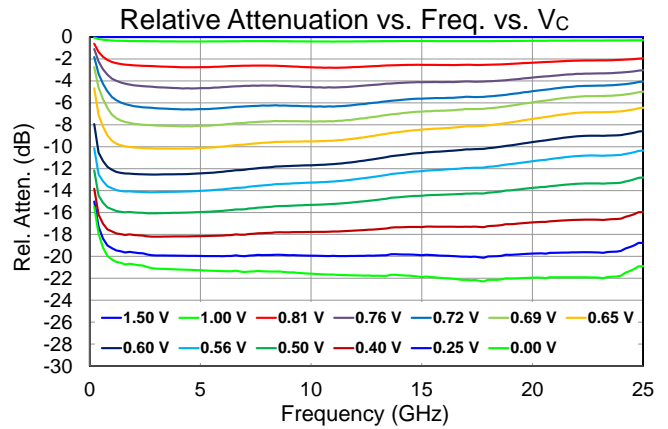
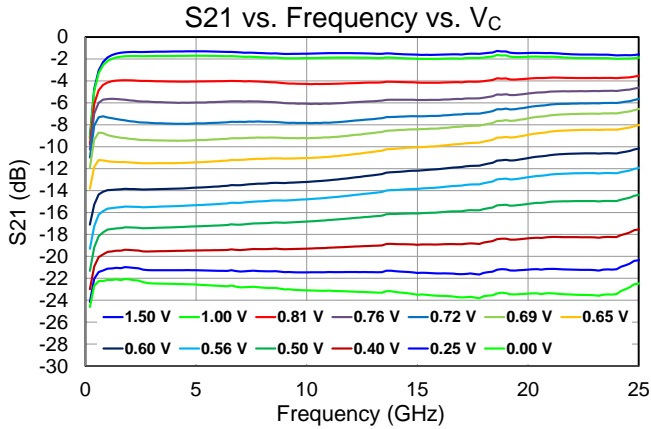

Typical Performance – Small Signal

Test conditions unless otherwise noted: Temp. = 25 °C,  $V_S = 1.5$  V, tested with DUT mounted to EVB

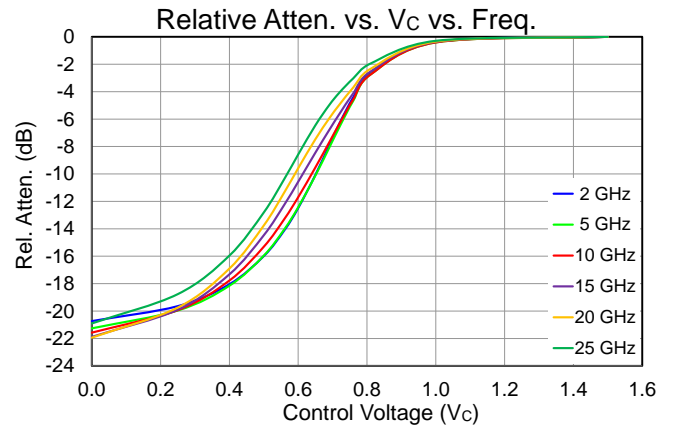
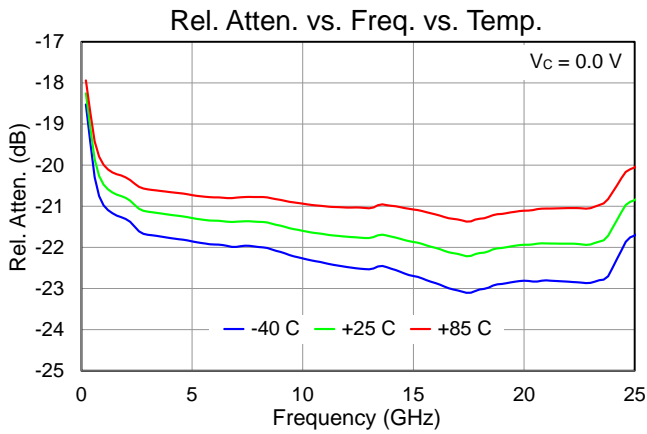

## Typical Performance – Power Performance

Test conditions unless otherwise noted: Temp. = 25 °C,  $V_S = 1.5$  V, tested with DUT mounted to EVB

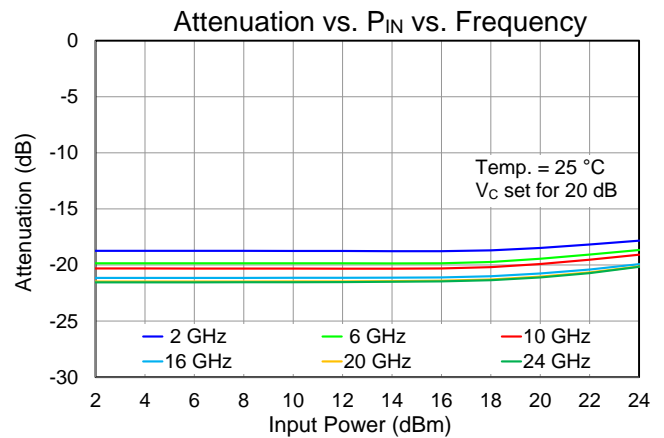
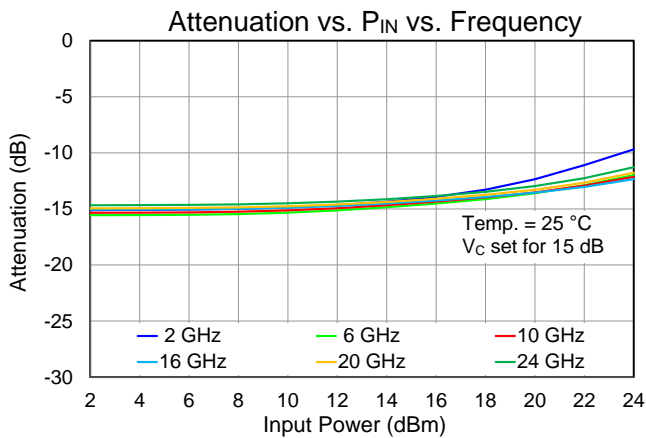
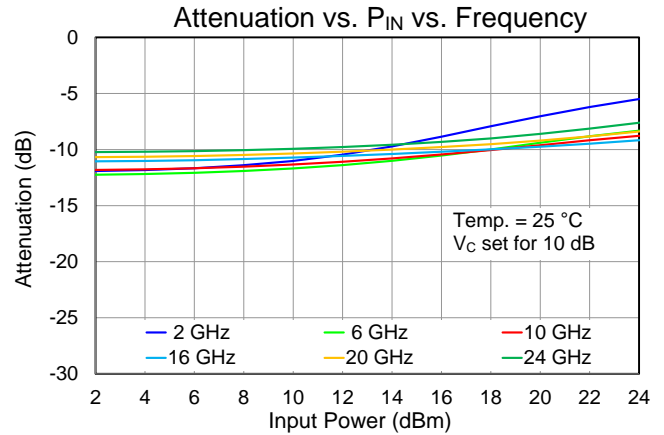
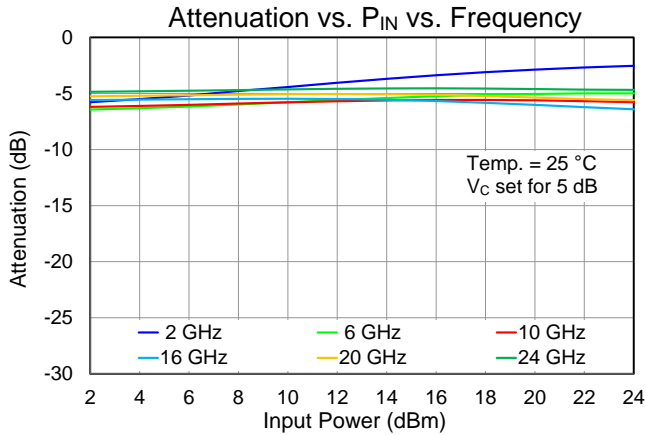

## Typical Performance – Linearity

Test conditions unless otherwise noted: Temp. = 25 °C,  $V_S = 1.5$  V, tested with DUT mounted to EVB

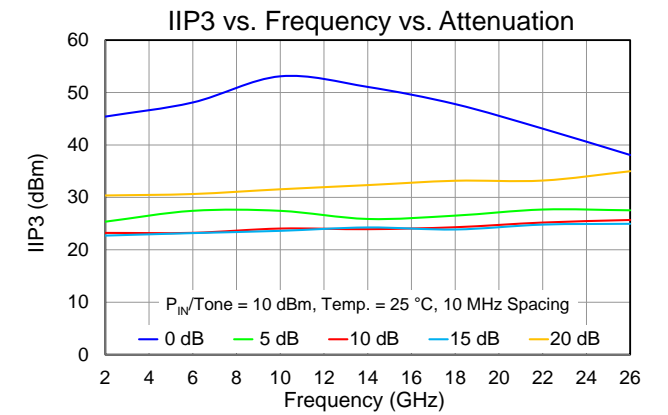
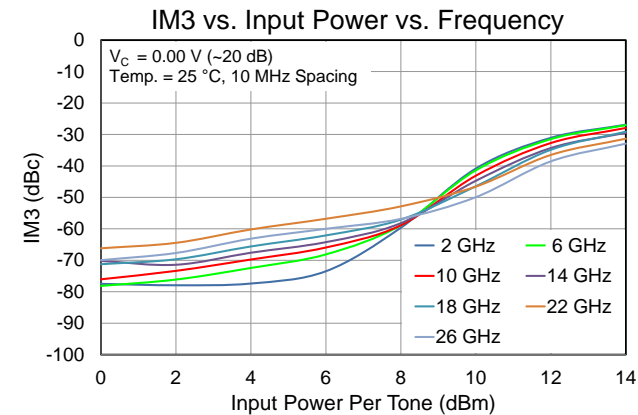
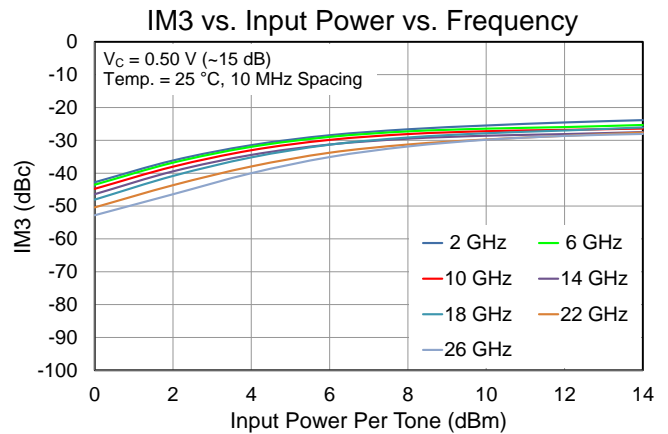
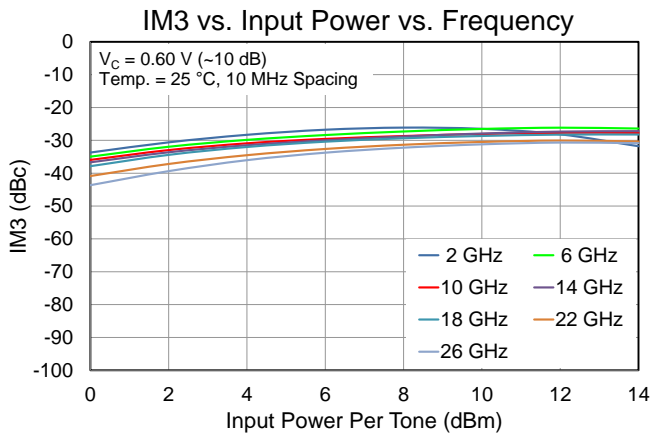
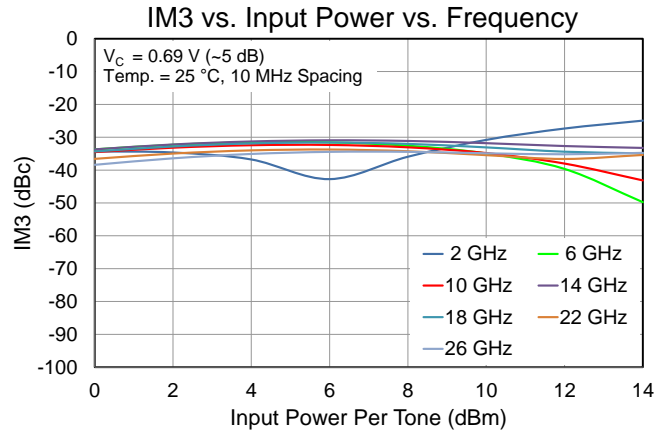
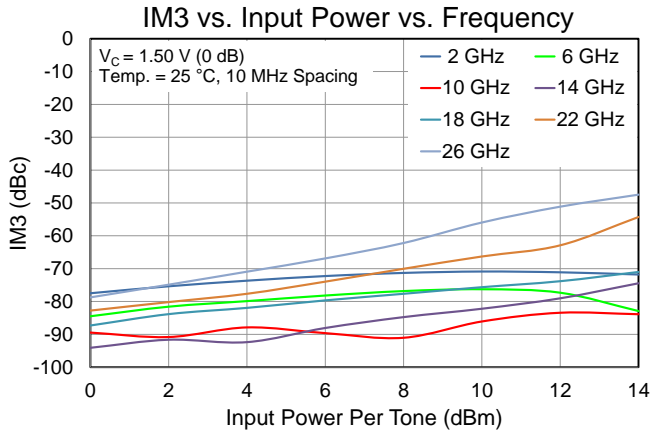

## Thermal and Reliability Information

Parameter	Conditions	Value	Units
Thermal Resistance ( $\theta_{JC}$ ) <sup>(1)</sup>	$T_{BASE} = 85\text{ °C}$ , $V_C = 0\text{ V}$ , $P_{DISS} = 1.0\text{ W}$	40.0	°C/W
Channel Temperature ( $T_{CH}$ ) <sup>(1)</sup>		125.0	°C
Median Lifetime ( $T_M$ )		2.4E+7	Hrs

Note:

- Die mounted to 40 mil thick CuMo carrier plate, with carrier plate backside temperature fixed at 85 °C.

## Median Lifetime

Test Conditions: 6.0 V; Failure Criterion = 10% reduction in  $I_{D\text{ MAX}}$

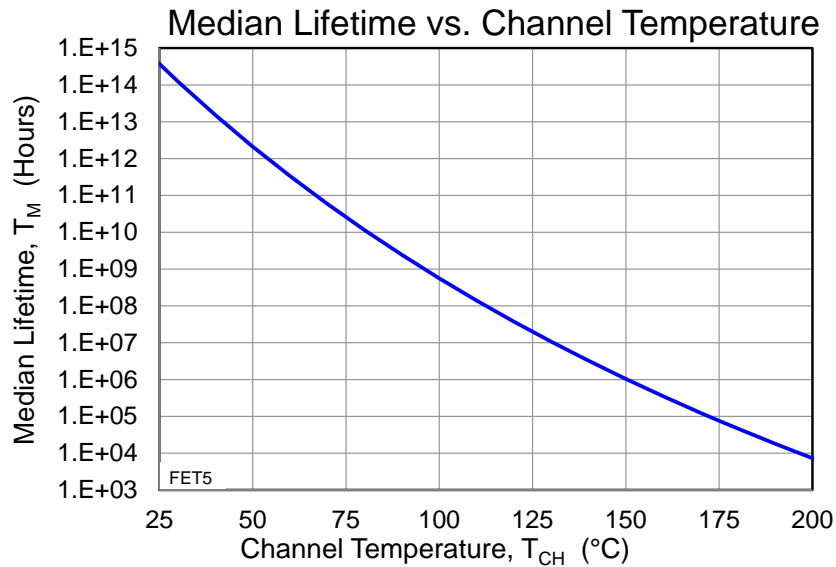

Application Circuit

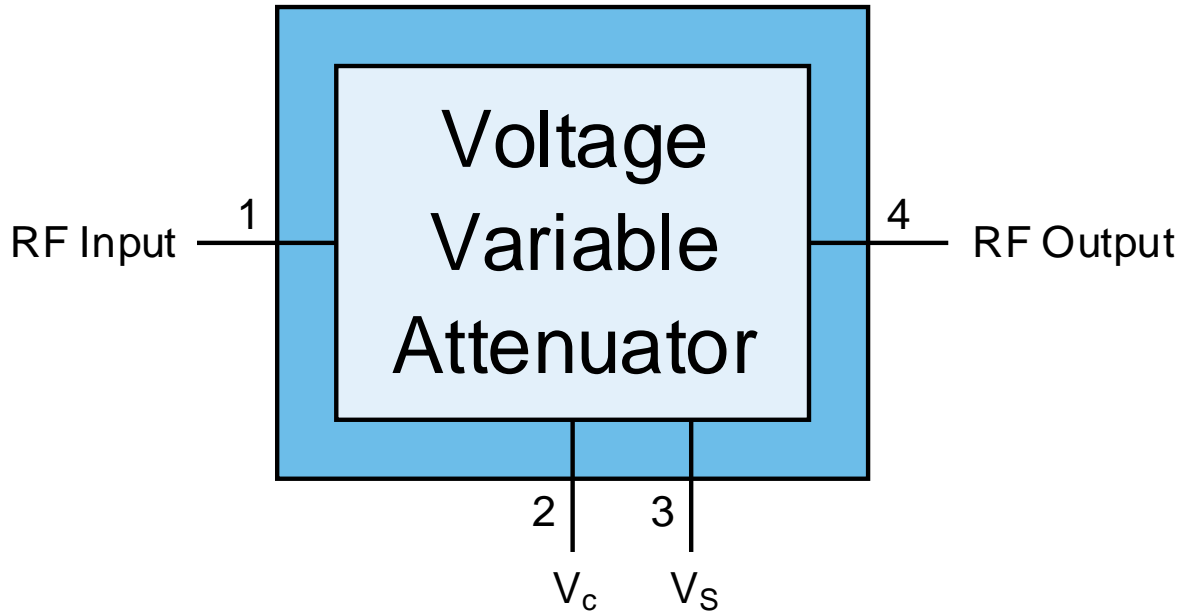

Notes:  $V_c \leq V_s$



### Evaluation Board Layout

RF Layer is 0.008" thick Rogers Corp. RO4003C,  $\epsilon_r = 3.38$ . Metal layers are 0.5 oz. copper. The microstrip line at the connector interface is optimized for the Southwest Microwave end launch connector 1092-01A-5.

The pad pattern shown has been developed and tested for optimized assembly at Qorvo Semiconductor. The PCB land pattern has been developed to accommodate lead and package tolerances. Since surface mount processes vary from company to company, careful process development is recommended.

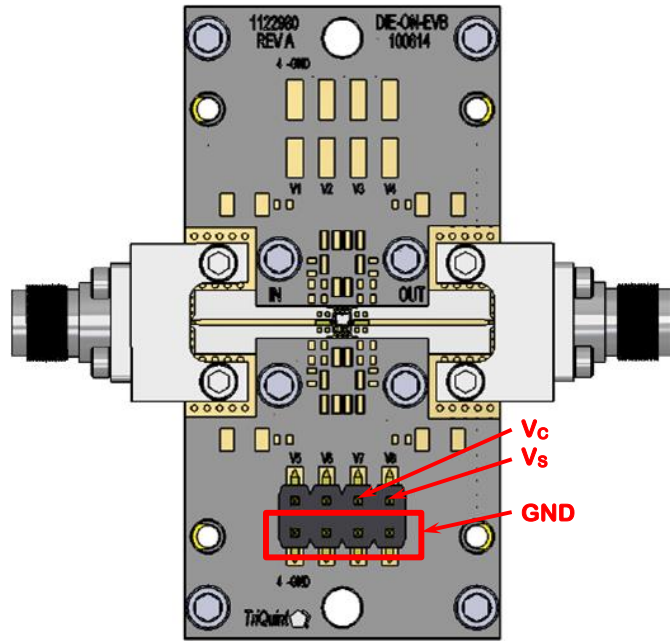

### EVB Die Mounting Detail

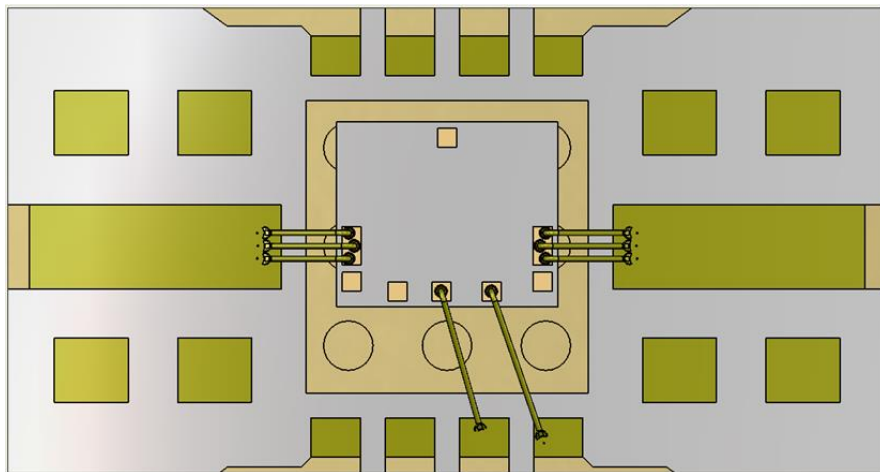

Note:

1. Multiple copper-filled vias should be employed under die to minimize inductance and thermal resistance.

Mechanical Drawing & Bond Pad Description

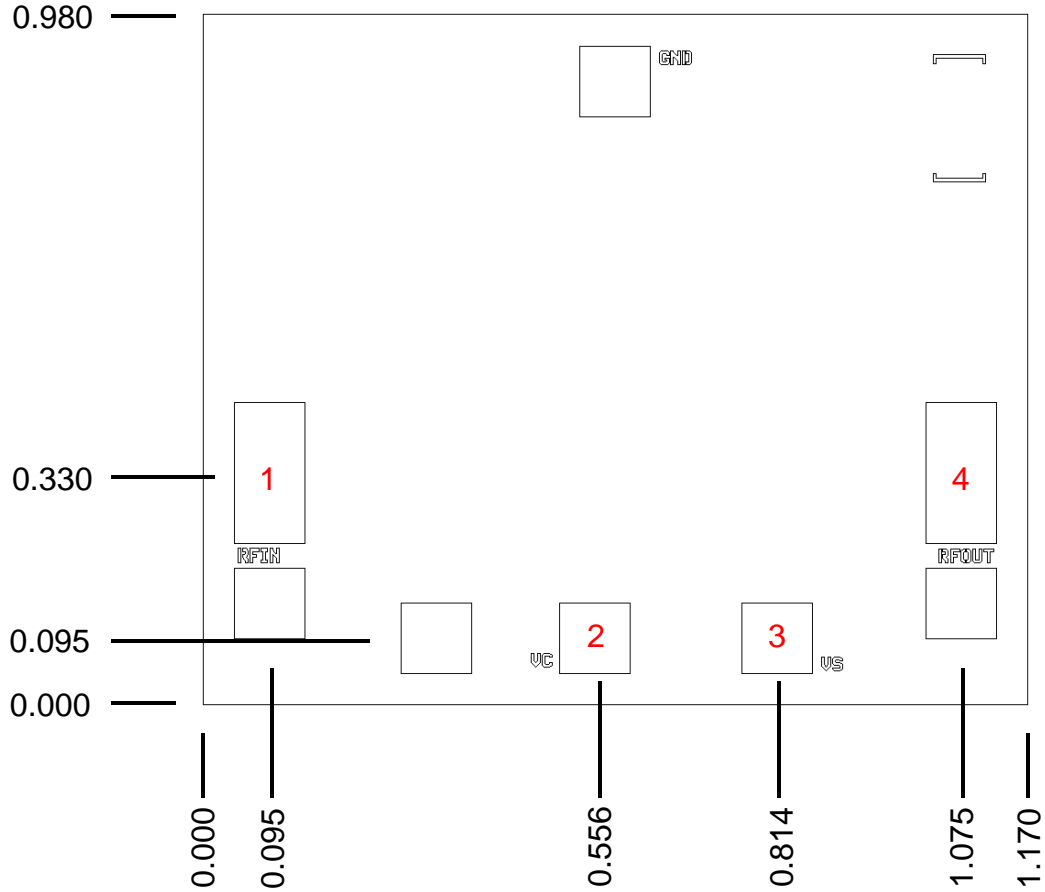

Unit: millimeters  
 Thickness: 0.10  
 Die x, y size tolerance: ± 0.050  
 Chip edge to bond pad dimensions are shown to center of pad  
 Ground is backside of die

Pin No.	Symbol	Pad Size (um x um)	Description
1	RF Input	100 x 200	RF Input, 50 Ω, AC coupled
2	Vc	100 x 100	Vc, control voltage
3	Vs	100 x 100	Vs, reference voltage
4	RF Output	100 x 200	RF Output, 50 Ω, AC coupled

## Assembly Notes

---

Component placement and adhesive attachment assembly notes:

- Vacuum pencils and/or vacuum collets are the preferred method of pick up.
- Air bridges must be avoided during placement.
- The force impact is critical during auto placement.

Reflow process assembly notes:

- Use AuSn (80/20) solder and limit exposure to temperatures above 300 °C to 3-4 minutes, maximum.
- An alloy station or conveyor furnace with reducing atmosphere should be used.
- Do not use any kind of flux.
- Coefficient of thermal expansion matching is critical for long-term reliability.
- Devices must be stored in a dry nitrogen atmosphere.

Interconnect process assembly notes:

- Thermosonic ball bonding is the preferred interconnect technique.
- Force, time, and ultrasonic levels are critical parameters.
- Aluminum wire should not be used.
- Devices with small pad sizes should be bonded with 0.0007-inch wire.

## Handling Precautions

Parameter	Rating	Standard
ESD – Human Body Model (HBM)	Class 1A	ANSI/ESD/JEDEC JS-001



Caution!  
ESD-Sensitive Device

## Solderability

Use only AuSn (80/20) solder, and limit exposure to temperatures above 300 °C to 3–4 minutes, maximum.

## RoHS Compliance

This part is compliant with 2011/65/EU RoHS directive (Restrictions on the Use of Certain Hazardous Substances in Electrical and Electronic Equipment) as amended by Directive 2015/863/EU.

This product also has the following attributes:

- Lead Free
- Halogen Free (Chlorine, Bromine)
- Antimony Free
- TBBP-A (C<sub>15</sub>H<sub>12</sub>Br<sub>4</sub>O<sub>2</sub>) Free
- PFOS Free
- SVHC Free

## Contact Information

For the latest specifications, additional product information, worldwide sales and distribution locations:

**Tel:** 1-844-890-8163

**Web:** [www.qorvo.com](http://www.qorvo.com)

**Email:** [customer.support@qorvo.com](mailto:customer.support@qorvo.com)

## Important Notice

The information contained herein is believed to be reliable; however, Qorvo makes no warranties regarding the information contained herein and assumes no responsibility or liability whatsoever for the use of the information contained herein. All information contained herein is subject to change without notice. Customers should obtain and verify the latest relevant information before placing orders for Qorvo products. The information contained herein or any use of such information does not grant, explicitly or implicitly, to any party any patent rights, licenses, or any other intellectual property rights, whether with regard to such information itself or anything described by such information. **THIS INFORMATION DOES NOT CONSTITUTE A WARRANTY WITH RESPECT TO THE PRODUCTS DESCRIBED HEREIN, AND QORVO HEREBY DISCLAIMS ANY AND ALL WARRANTIES WITH RESPECT TO SUCH PRODUCTS WHETHER EXPRESS OR IMPLIED BY LAW, COURSE OF DEALING, COURSE OF PERFORMANCE, USAGE OF TRADE OR OTHERWISE, INCLUDING THE IMPLIED WARRANTIES OF MERCHANTABILITY AND FITNESS FOR A PARTICULAR PURPOSE.**

Without limiting the generality of the foregoing, Qorvo products are not warranted or authorized for use as critical components in medical, life-saving, or life-sustaining applications, or other applications where a failure would reasonably be expected to cause severe personal injury or death.

Copyright 2021 © Qorvo, Inc. | Qorvo is a registered trademark of Qorvo, Inc.

## X-ON Electronics

Largest Supplier of Electrical and Electronic Components

*Click to view similar products for [Attenuators](#) category:*

*Click to view products by [Qorvo](#) manufacturer:*

Other Similar products are found below :

[HMC305SLP4ETR](#) [MAAD-009195-000100](#) [TGL4201-00](#) [TGL4201-02](#) [TGL4201-03](#) [TGL4201-06](#) [TGL4201-10](#) [ATN3590-15](#) [20-50TPC](#)  
[D10AA5Z4](#) [18AH-01](#) [18AH-08](#) [ATN3580-20](#) [ATN3590-09](#) [20-50RP](#) [MASW-008322-000000](#) [MAATCC0009TR](#) [PCAF-10](#) [EXB-](#)  
[24AT9AR5X](#) [ATN3580-06](#) [ATN3580-10](#) [HMC539ALP3ETR](#) [ATN3580-02](#) [ATN3590-07](#) [SKY12408-321LF](#) [ATN3580-03](#)  
[WA04P005XBTL](#) [HMC-VVD104-SX](#) [WA04P007XCTL](#) [SKY12236-11](#) [MAATSS0018TR-3000](#) [HMC656-SX](#) [WA04P001XBTL](#) [MAAV-](#)  
[007941-TR3000](#) [WA04P004XBTL](#) [WA04P002XBTL](#) [C3A50Z4](#) [HMC941A](#) [PAT0816-C-0DB-T5](#) [PAT0816-C-8DB-T5](#) [PAT1632-C-3DB-](#)  
[T1](#) [PAT1632-C-6DB-T1](#) [PAT1632-C-10DB-T1](#) [PAT1632-C-1DB-T1](#) [PAT0816-C-2DB-T5](#) [PAT0816-C-4DB-T5](#) [DHM510-0100-006](#)  
[CMD172](#) [MAT10300](#) [MAT10180](#)