



# TGP2105-SM

## 6 - 18 GHz 6-Bit Digital Phase Shifter (+Vc)

### Product Description

The Qorvo TGP2105-SM is a packaged 6-bit digital phase shifter fabricated on Qorvo's high performance 0.15 um GaAs pHEMT process. It operates over 6 to 18 GHz while providing 360° of phase coverage with a LSB of 5.625°. It also achieves a low RMS phase error of 4° with 8 dB of insertion loss over all states.

The TGP2105-SM uses positive switch logic, eliminating the need for a negative voltage rail. That, along with low insertion and a high degree of resolution makes the TGP2105-SM ideally suited for a variety of wideband phased array applications, including commercial and military radars, satellite-based communication systems and electronic warfare.

The device is lead-free and RoHS compliant.

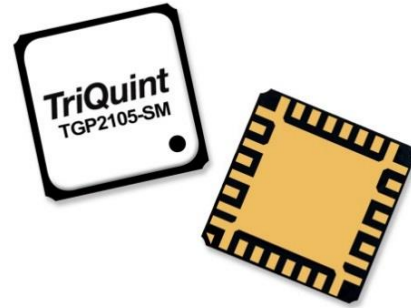

Air Cavity Ceramic QFN 5x5 mm 32L

### Product Features

- Frequency Range: 6 to 18 GHz
- 6-Bit Digital Phase Shifter
- 360° Coverage, LSB = 5.625°
- RMS Phase Error: 4°
- RMS Amplitude Error: 0.45 dB
- Insertion Loss: <10 dB
- Return Loss: >12 dB
- Input P1dB: >25 dBm
- Input IP3: >41 dBm
- Control Voltage: 0/+5V
- QFN Package Dimensions: 5.0 x 5.0 x 1.45 mm

*Performance is typical across frequency. Please reference electrical specification table and data plots for more details.*

### Functional Block Diagram

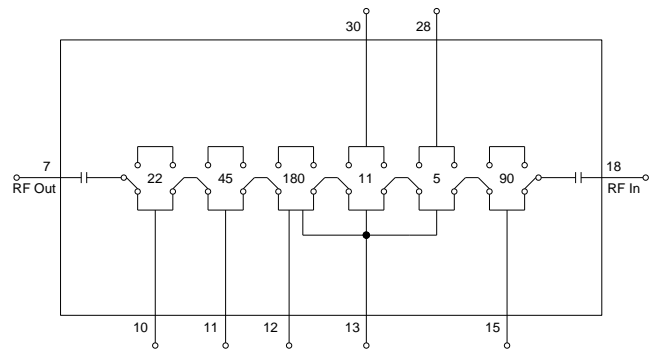

### Applications

- Phased Array Antenna Systems
- Satellite Communication Systems
- Electronic Warfare

### Ordering Information

Part No.	Description
TGP2105-SM	6-18 GHz 6-Bit Digital Phase Shifter
TGP2105-SMEVB01	TGP2105-SM Evaluation Board



# TGP2105-SM

## 6 - 18 GHz 6-Bit Digital Phase Shifter (+Vc)

### Absolute Maximum Ratings

Parameter	Value
Control and Reference Voltage	6 V
Control Current	-15 to +5 mA
Power Dissipation	0.9 W
Input Power, CW, 50 Ω, 85°C	30 dBm
Channel Temperature	200 °C
Mounting Temperature (30 Seconds)	260 °C
Storage Temperature	-55 to 150 °C

Operation of this device outside the parameter ranges given above may cause permanent damage. These are stress ratings only, and functional operation of the device at these conditions is not implied. Extended application of Absolute Maximum Rating conditions may reduce device reliability.

### Recommended Operating Conditions

Parameter	Value
Control Voltage (5°, 11°, 22°, 45°, 90°, 180°, REF)	0/+5 V
Operating Temperature Range	-40 °C to +85 °C

Electrical specifications are measured at specified test conditions. Specifications are not guaranteed overall operating conditions.

### Electrical Specifications

Test conditions unless otherwise noted: 25 °C. Control Voltage (REF, 5°, 11°, 22°, 45°, 90°, 180°) = 0/+5 V; See Bias Truth Table.

Parameter	Conditions	Min	Typical	Max	Units
Operational Frequency Range		6		18	GHz
Insertion Loss			6 - 10		dB
Input Return Loss			>12		dB
Output Return Loss			>12		dB
RMS Phase Error			4		deg
RMS Amplitude Error			0.45		dB
Input P1dB			> 25		dBm
Input IP3	Tone Spacing = 10 MHz, Pin/Tone = 15 dBm		> 41		dBm
Insertion Loss Temperature Coefficient			0.008		dB/°C

### Bias Truth Table

Logic "0" = 0 V, Logic "1" = +5 V

Voltage for Logic "1" of V<sub>CTRL</sub> (5°, 11°, 22°, 45°, 90°, 180°) must be the same with V<sub>REF</sub>

Phase Shifter	5°	11°	22°	45°	90°	180°	REF
0° (Reference)	0	0	0	0	0	0	1
5°	1	0	0	0	0	0	1
11°	0	1	0	0	0	0	1
22°	0	0	1	0	0	0	1
45°	0	0	0	1	0	0	1
90°	0	0	0	0	1	0	1
180°	0	0	0	0	0	1	1
355°	1	1	1	1	1	1	1

### Performance Plots – Small Signal

Test conditions unless otherwise noted: 25 °C. Data de-embedded to device reference planes

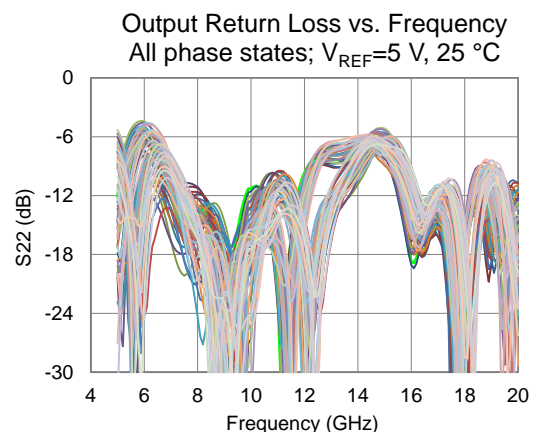
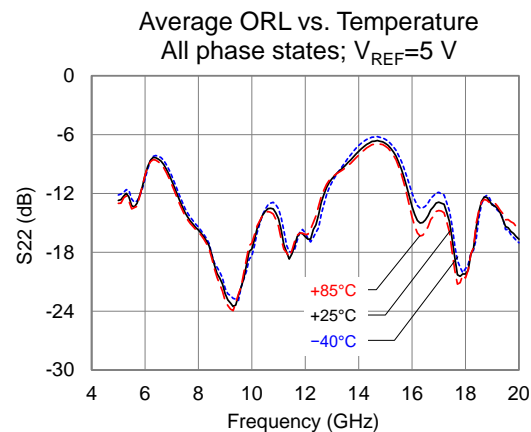
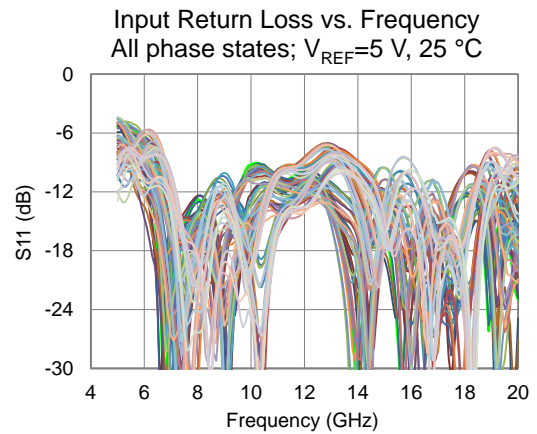
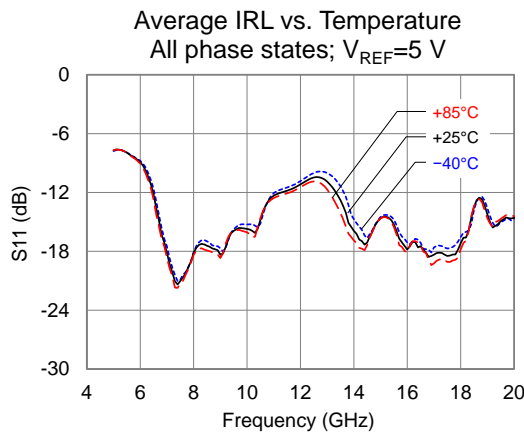
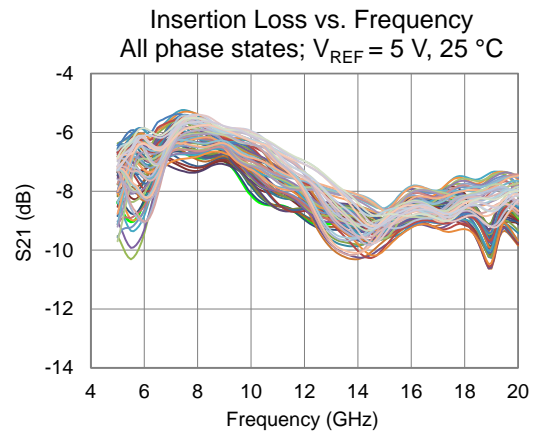
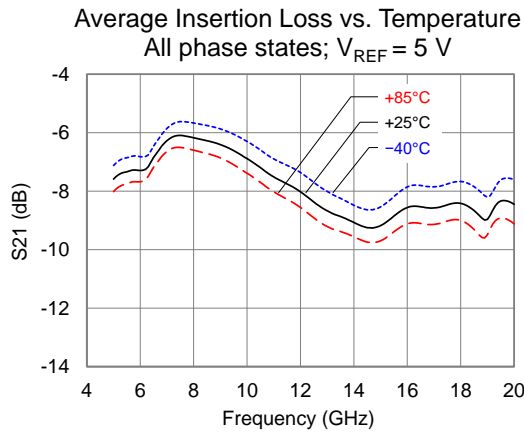

### Performance Plots – Small Signal

Test conditions unless otherwise noted: 25 °C. Data de-embedded to device reference planes

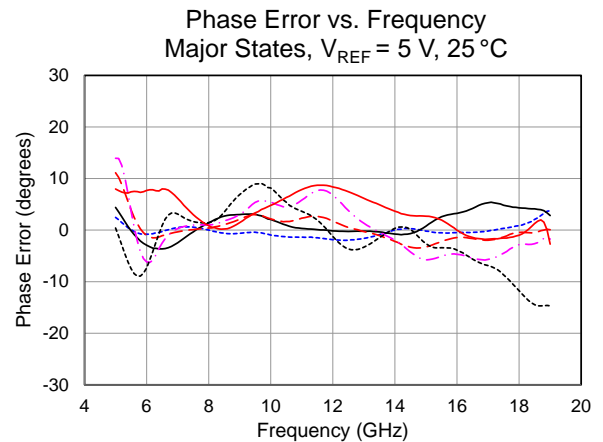
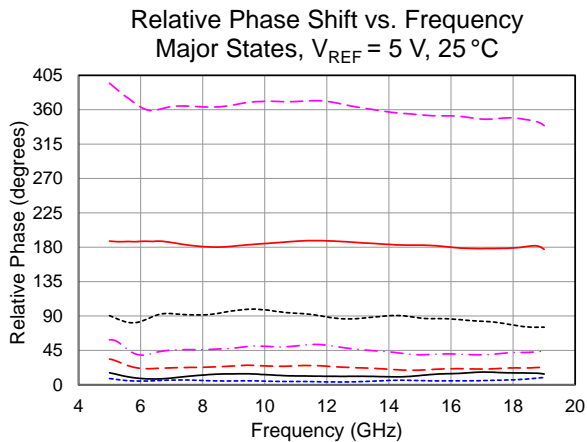
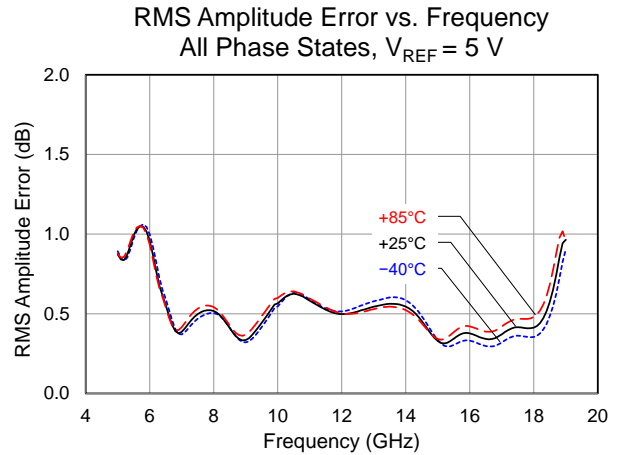
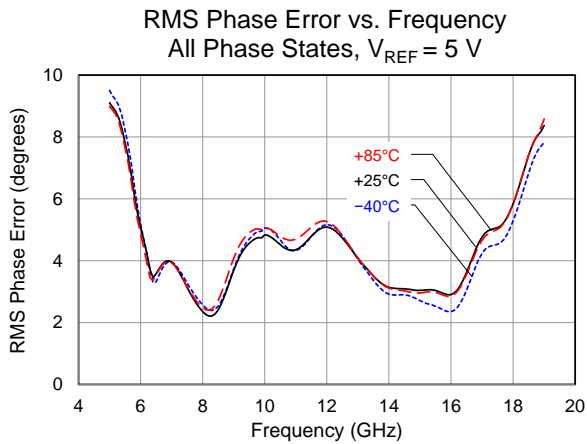
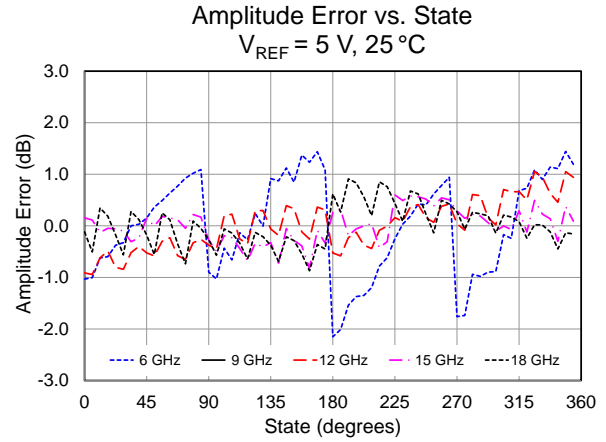
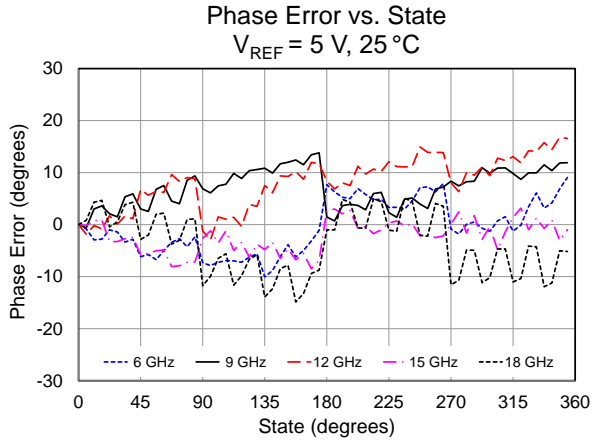

### Performance Plots – Small Signal

Test conditions unless otherwise noted: 25 °C. Data de-embedded to device reference planes

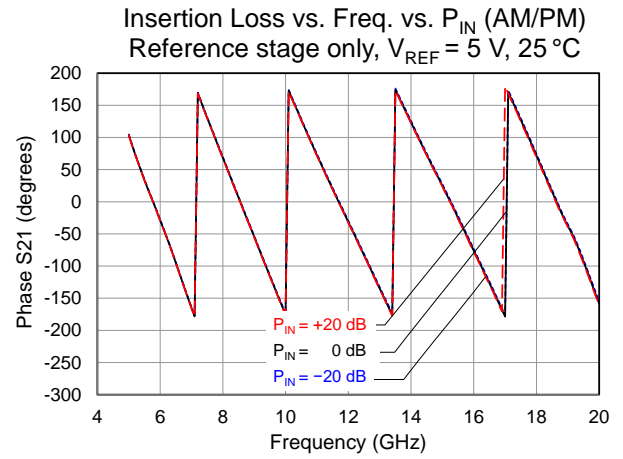
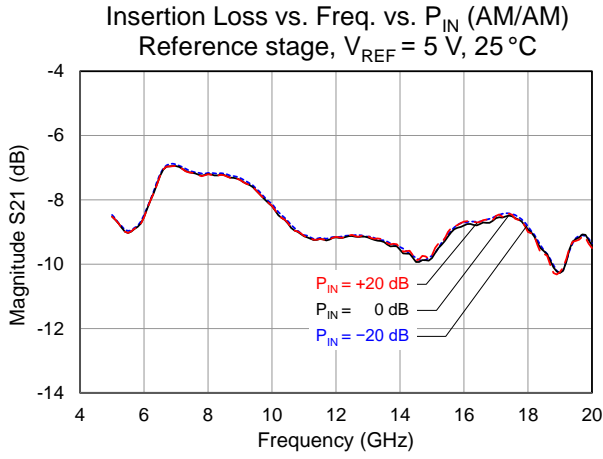

## Package Pin Descriptions

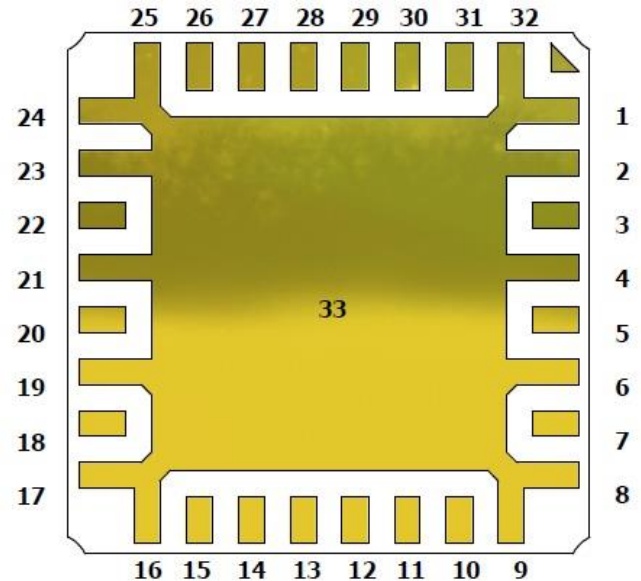
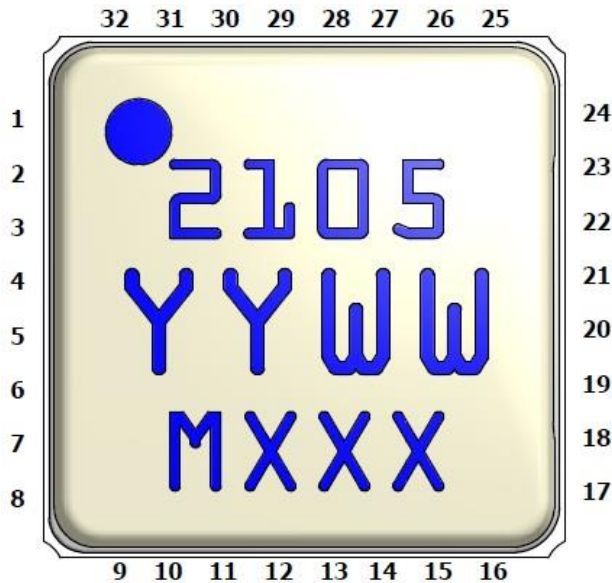

Package Pad	Symbol	Description
1 - 6, 8 - 9, 14, 16,17, 19 - 27, 29, 31 - 32	GND	Internal grounding; must be grounded on PCB
7	RF Out	Output; matched to 50 Ohms; DC blocked
10	22°	22° Bit; De-Qing network is not required
11	45°	45° Bit; De-Qing network is not required
12	180°	180° Bit; De-Qing network is not required
13	REF	Reference; De-Qing network is not required
15	90°	90° Bit; De-Qing network is not required
18	RF In	Input; matched to 50 Ohms; DC blocked
28	5°	5° Bit; De-Qing network is not required
30	11°	11° Bit; De-Qing network is not required
33	GND	On PCB; multiple vias should be employed under the center pad (33) to minimize inductance and thermal resistance; see page 8 for suggested vias layout

### Package Mechanical Drawing and Dimensions

All dimensions are in inches and that unless otherwise noted the tolerance is +/- 0.005

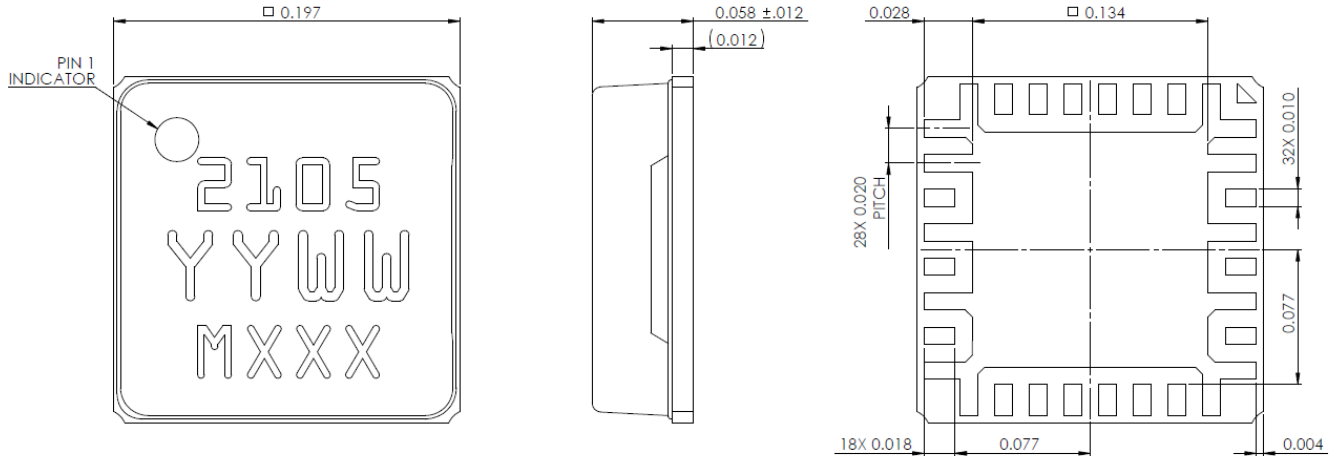

**NOTES:**

1. MATERIALS:  
 PACKAGE BASE: CERAMIC  
 PACKAGE LID: PLASTIC
  2. PART IS EPOXIED SEALED.
  3. PLATING: ALL METALIZED FEATURES ARE GOLD PLATED.
3. PART MARKING:
- 2105 : PART NUMBER
  - YY : PART ASSEMBLY YEAR
  - WW : PART ASSEMBLY WEEK
  - MXXX : BATCH ID

### Evaluation Board (EVB) Layout Assembly

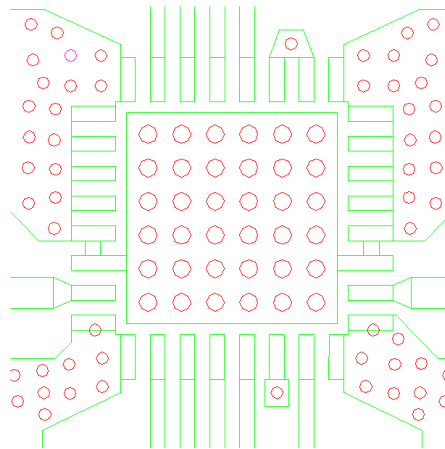
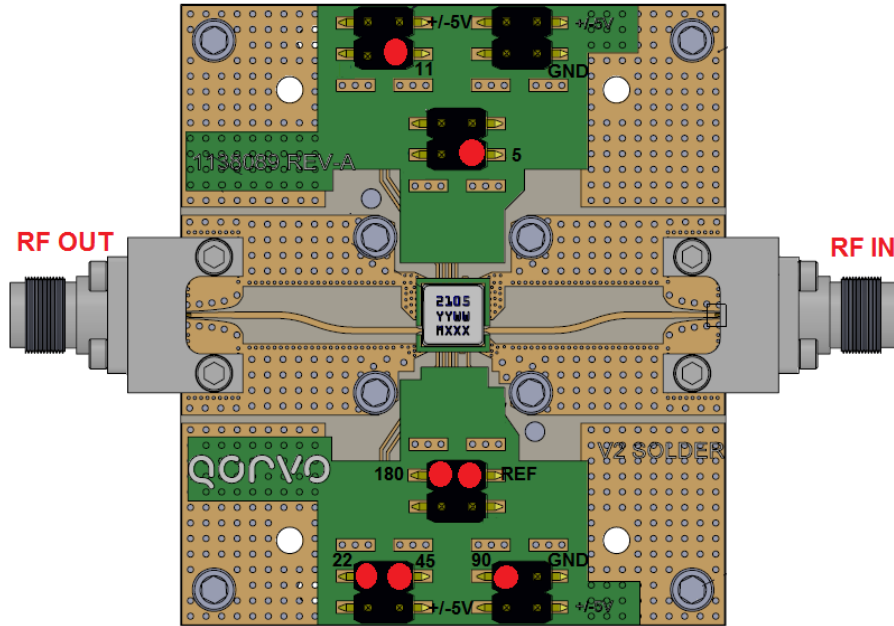

Via Pattern

RF layer is 0.010" thick Rogers RO4350. Metal layers are 1-oz copper. The microstrip line taper at the connector interface is optimized for the Southwest Microwave end-launch connector 1092-01A-5.

Ground / thermal vias under the DUT are critical for the proper performance of this device. The PCB shown herein utilizes copper filled vias under the DUT.

The pad pattern shown has been developed and tested for optimized assembly at Qorvo. The PCB land pattern has been developed to accommodate lead and package tolerances. Since surface mount processes vary from company to company careful process development is recommended.



### Thermal and Reliability Information

Parameter	Test Conditions	Value	Units
Thermal Resistance ( $\theta_{JC}$ ) <sup>(1)</sup>	$P_{DISS} = 0.09\text{ W}$ , $T_{BASE} = 85^{\circ}\text{C}$	22	$^{\circ}\text{C/W}$
Channel Temperature ( $T_{CH}$ ) <sup>(2)</sup>		87	$^{\circ}\text{C}$
Median Lifetime ( $T_M$ )		3.8E+9	Hrs

Notes:

1. Thermal resistance measured to back of package.
2. Under normal (lifetime) operating conditions, self-heating is not a significant contributor to channel temperature.

### Median Lifetime

Test Conditions: 6.0 V; Failure Criterion = 10% reduction in  $I_{DQ\_MAX}$

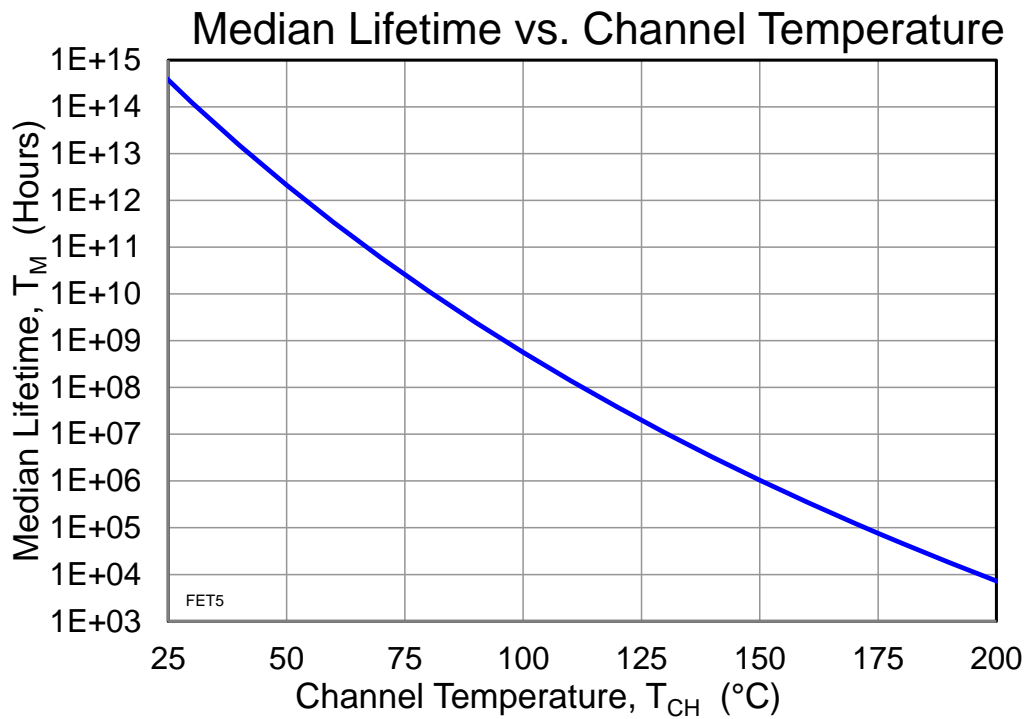

### Solderability

1. Compatible with the latest version of J-STD-020, Lead-free solder, 260 °C
2. The use of no-clean solder to avoid washing after soldering is recommended.
3. Package lead plating: NiAu

### Recommended Soldering Temperature Profile

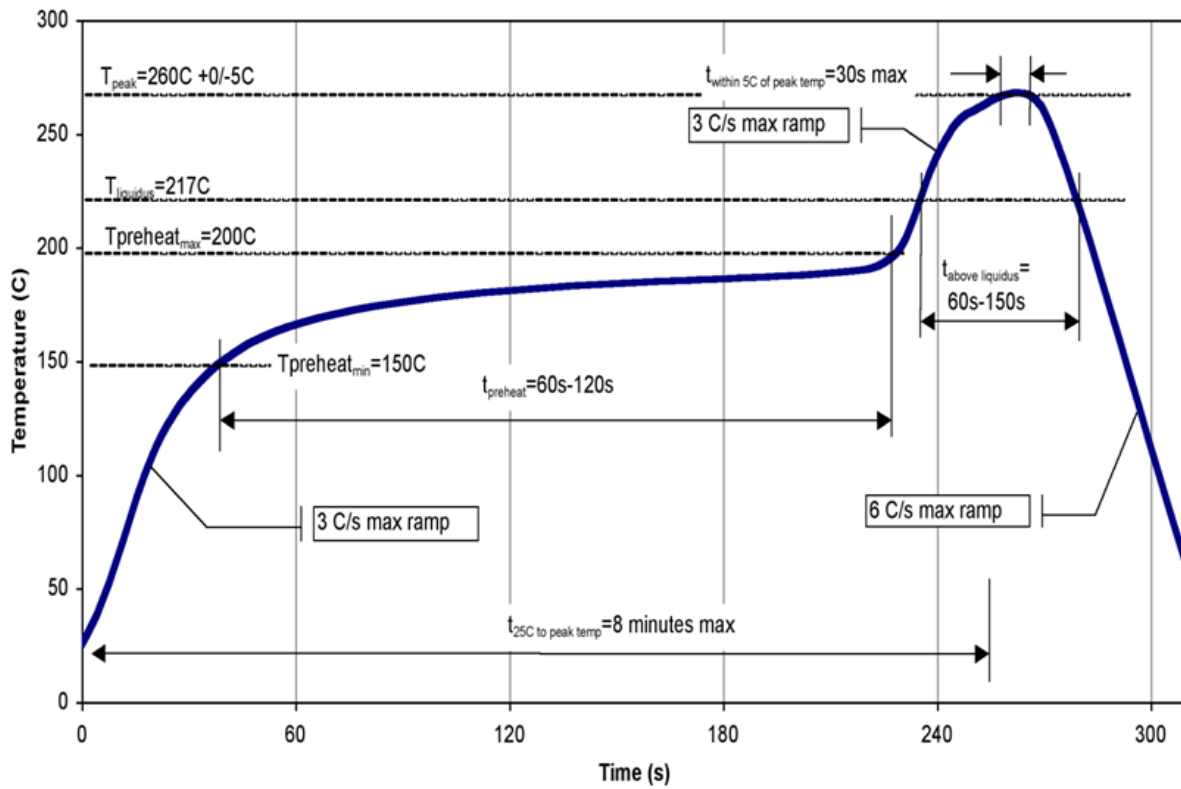

### Handling Precautions

Parameter	Rating	Standard
ESD – Human Body Model (HBM)	Class 1A	ESDA / JEDEC JS-001-2012
ESD – Charge Device Model (CDM)	Class C2a	JS-002-2014
MSL – Moisture Sensitivity Level	Level 3	IPC/JEDEC J-STD-020



Caution!  
ESD-Sensitive Device

### RoHS Compliance

This product is compliant with the 2011/65/EU RoHS directive (Restrictions on the Use of Certain Hazardous Substances in Electrical and Electronic Equipment), as amended by Directive 2015/863/EU. This product also has the following attributes:

- Lead Free
- Halogen Free (Chlorine, Bromine)
- Antimony Free
- TBBP-A (C<sub>15</sub>H<sub>12</sub>Br<sub>4</sub>O<sub>2</sub>) Free
- PFOS Free
- SVHC Free

### Contact Information

For the latest specifications, additional product information, worldwide sales and distribution locations:

**Tel:** 1-844-890-8163

**Web:** [www.qorvo.com](http://www.qorvo.com)

**Email:** [customer.support@qorvo.com](mailto:customer.support@qorvo.com)

For technical questions and application information: **Email:** [appsupport@qorvo.com](mailto:appsupport@qorvo.com)

### Important Notice

The information contained herein is believed to be reliable; however, Qorvo makes no warranties regarding the information contained herein and assumes no responsibility or liability whatsoever for the use of the information contained herein. All information contained herein is subject to change without notice. Customers should obtain and verify the latest relevant information before placing orders for Qorvo products. The information contained herein or any use of such information does not grant, explicitly or implicitly, to any party any patent rights, licenses, or any other intellectual property rights, whether with regard to such information itself or anything described by such information. **THIS INFORMATION DOES NOT CONSTITUTE A WARRANTY WITH RESPECT TO THE PRODUCTS DESCRIBED HEREIN, AND QORVO HEREBY DISCLAIMS ANY AND ALL WARRANTIES WITH RESPECT TO SUCH PRODUCTS WHETHER EXPRESS OR IMPLIED BY LAW, COURSE OF DEALING, COURSE OF PERFORMANCE, USAGE OF TRADE OR OTHERWISE, INCLUDING THE IMPLIED WARRANTIES OF MERCHANTABILITY AND FITNESS FOR A PARTICULAR PURPOSE.**

Without limiting the generality of the foregoing, Qorvo products are not warranted or authorized for use as critical components in medical, life-saving, or life-sustaining applications, or other applications where a failure would reasonably be expected to cause severe personal injury or death.

Copyright 2018 © Qorvo, Inc. | Qorvo is a registered trademark of Qorvo, Inc.

## X-ON Electronics

Largest Supplier of Electrical and Electronic Components

*Click to view similar products for [Phase Detectors/Shifters](#) category:*

*Click to view products by [Qorvo](#) manufacturer:*

Other Similar products are found below :

[TGP2100](#) [MAPS-010163-TR1000](#) [HMC933LP4ETR](#) [HMC934LP5ETR](#) [HMC647LP6ETR](#) [MAPS-010166-001SMB](#) [HMC247-SX](#)  
[HMC543ALC4B](#) [HMC642ALC5](#) [HMC648ALP6E](#) [HMC936ALP6E](#) [HMC984LP4E](#) [MAPS-010146-TR0500](#) [MAPS-010163-001SMB](#)  
[MAPS-010163-TR0500](#) [MAPS-010164-TR0500](#) [MAPS-010166-TR0500](#) [HMC642ALC5TR](#) [HMC649ALP6E](#) [HMC984LP4ETR](#) [MAPS-](#)  
[010143-TR0500](#) [MAPS-010165-TR0500](#) [HMC649ALP6ETR](#) [MC100EP140DG](#) [MC100EP40DTG](#) [MC100LVEL40DWG](#) [PE44820B-X](#)  
[CHP3015-QDG](#) [CMD176P4](#) [QPC2108](#) [HMC644ALC5](#) [MAPS-010145-TR0500](#) [MAPS-010144-TR0500](#) [TGP2108-SM](#) [MAPS-010143-](#)  
[001SMB](#) [MAPS-010144-001SMB](#) [MAPS-010145-001SMB](#) [MAPS-010164-001SMB](#) [HMC644ALC5TR](#) [MC100LVEL40DWR2G](#) [TGP2107-](#)  
[SM](#) [TGP2107](#) [TGP2109](#) [TGP2109-SM](#)