

Applications

- CDMA/LTE handsets
- Data card
- Mobile router
- Extension PCS Band Class 14
- LTE Band 25

Product Features

- Excellent triple beat performance: -88 dBc
- Highly selective BAW duplexer achieving low insertion loss over full bandwidth and operating conditions.
- Downlink isolation of 50 dB minimum & GPS rejection of >40 dB eliminating the need for a transmit filter
- Single-Ended (SE) 50 Ohm Downlink & Uplink Ports
- Performance -30 to $+85$ °C
- RoHS compliant, Pb-free module package

General Description

The TQM963001 is a high-performance Bulk Acoustic Wave (BAW) duplexer designed to meet the strict CDMA requirements in the PCS extension band BC14 and provide excellent insertion loss, cross isolation and linearity for LTE B25.

TQM963001 is specifically designed to meet the high performance expectations of insertion loss, isolation and triple beat for CDMA systems over the extended bandwidth of BC14 applications under all operating conditions. Exceptional downlink isolation and GPS rejection performance eliminates the need for an uplink SAW filter.

The TQM963001 uses common module packaging techniques to achieve the industry standard 2.6 x 2.1 x 0.9 mm footprint. This duplexer exhibits excellent power handling capabilities.

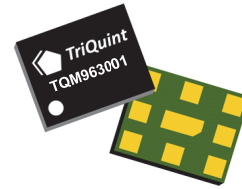

8 Pin 2.6 x 2.1 mm Package

Functional Block Diagram

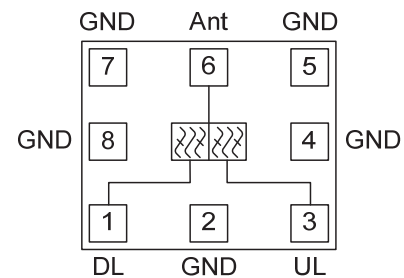

Top View

Pin Configuration

Pin #	Symbol
1	DL (Downlink)
3	UL (Uplink)
6	Ant (Antenna)
8	GND (Optional)
2, 4, 5, 7, Center Pad	GND

Ordering Information

Part No.	Description
TQM963001	BC14 / B25 BAW Duplexer
TQM963001-PCB	Evaluation Board

Standard T/R size = 2500 pieces on a 7" reel.

Absolute Maximum Ratings

Parameter	Rating
Storage Temperature	-40 to +85 °C
RF Input Power CW, 5000 hours, 50 Ω, T = 25 °C	+29 dBm

Operation of this device outside the parameter ranges given above may cause permanent damage.

Recommended Operating Conditions

Parameter	Min	Typ	Max	Units
T _{CASE}	-30		+85	°C

The duplexer will function over the recommended range without degradation in reliability or permanent change in performance.

Electrical Specifications^(1,2) Antenna-Uplink

Test conditions unless otherwise noted: Temp. = -30 °C to +85 °C

Parameter	Conditions	Min	Typ ⁽³⁾	Max	Units
Insertion Loss	1850 – 1915 MHz (B25)		1.8	3.8	dB
Return Loss	1850 – 1915 MHz (Antenna Port)	9	12		dB
	1850 – 1915 MHz (Uplink Port)	11	15		
Attenuation	10 – 728 MHz	30	42		dB
	728 – 768 MHz	30	43		
	869 – 894 MHz	35	46		
	1565 – 1587 MHz (GPS)	40	50		
	1597 – 1606 MHz (Glonass)	42	51		
	1606 – 1680 MHz	30	44		
	1930 – 1995 MHz (B25 Downlink)	40	53		
	2110 – 2155 MHz (AWS Downlink)	34	39		
	2400 – 2500 MHz (ISM)	26	30		
	3700 – 3830 MHz (2 f ₀)	20	26		
	5150 – 5350 MHz (WiFi)	15	24		
	5550 – 5745 MHz (3 f ₀)	15	22		
7390 – 7670 MHz (4 f ₀)	10	21			
Amplitude Variation ⁽⁴⁾	1850 – 1915 MHz (B25)		0.7	1.7	dB

Electrical Specifications^(1,2) Antenna–Downlink

Test conditions unless otherwise noted: Temp. = -30 °C to +85 °C

Parameter	Conditions	Min	Typ ⁽³⁾	Max	Units
Insertion Loss	1930 – 1995 MHz (B25)		2.2	5.1	dB
Return Loss	1930 – 1995 MHz (Antenna Port)	9	11		dB
	1930 – 1995 MHz (Downlink Port)	9	11		
Attenuation	815 – 849 MHz (BC0 Uplink)	20	32		dB
	1850 – 1915 MHz (B25 Uplink)	45	63		
	2400 – 2484 MHz (ISM band)	30	43		
	2484 – 8000 MHz	25	47		
Amplitude Variation ⁽⁴⁾	1930 – 1995 MHz (B25)		1.3	1.8	dB _{p-p}
Linearity (Triple Beat Test) ⁽⁶⁾	Ratio of CW jammer to triple beat product at downlink port. Temp=+25 °C		-88 ⁽⁵⁾	-79	dBc

Electrical Specifications^(1,2) Uplink–Downlink Isolation

Test conditions unless otherwise noted: Temp. = -30 °C to +85 °C

Parameter	Frequency Band	Min	Typ ⁽³⁾	Max	Units
Isolation	1850 – 1915 MHz (B25)	51	62		dB
	1930 – 1995 MHz (B25)	47	54		
	1574 – 1577 MHz (GPS)	40	56		
	3700 – 3830 MHz (2 f ₀)	53	64		
	5540 – 5745 MHz (3 f ₀)	49	59		
Mid band Isolation ⁽⁴⁾	1915 – 1930 MHz, Temp=+25 °C	20			dB

Notes:

- All specifications are based on the TriQuint schematic for the main reference design.
- In production, devices will be tested at room temperature to a guard-banded specification to ensure electrical compliance over temperature.
- Typical values are averages over specified band, unless otherwise noted.
- Integrated over any 1.25 MHz channel within band.
- Worst case over specified frequencies.
- Test conditions defined as follows:
 Uplink port: Two CW signals at f_{uplink} and $f_{\text{uplink}}+1\text{MHz}$ and $P_{\text{out}}=+21.5$ dBm per tone measured at the DUT antenna port;
 Antenna port: CW jammer at $f_{\text{downlink}}=f_{\text{uplink}}+80$ MHz and $P_{\text{in}}=-30$ dBm.
 Triple Beat Ratio is defined as the ratio of the CW jammer to the triple-beat product at the downlink port for $f_{\text{uplink}}=1851$ MHz, 1882 MHz, and 1913 MHz.

TQM963001-PCB Evaluation Board

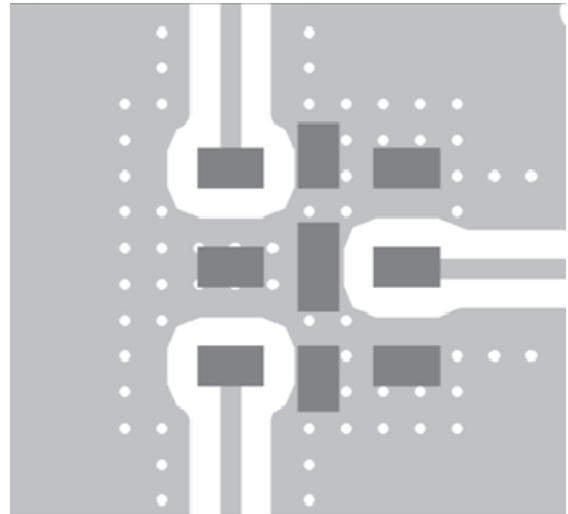
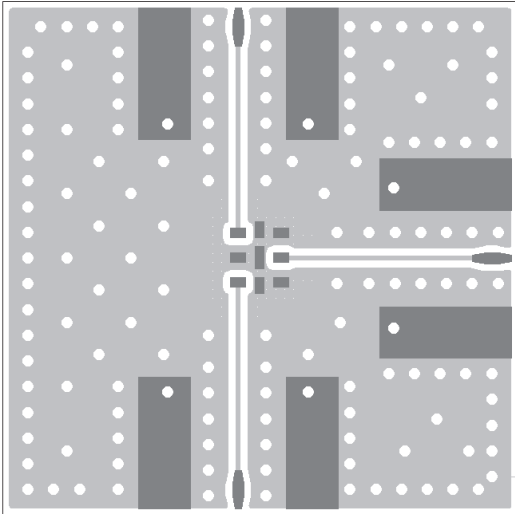

Notes:

1. Top, middle & bottom layers: 1 oz copper
2. Substrates: FR4 dielectric, .031" thick
3. Finish plating: Nickel: 3-8 μ m thick,
 Gold: .03-.2 μ m thick
4. Hole plating: Copper min .0008 μ m thick

Notes:

1. Light grey indicates metalized area
2. Dark grey indicates pad areas
3. This footprint represents a recommendation only
4. For solder pad recommendation see mechanical information

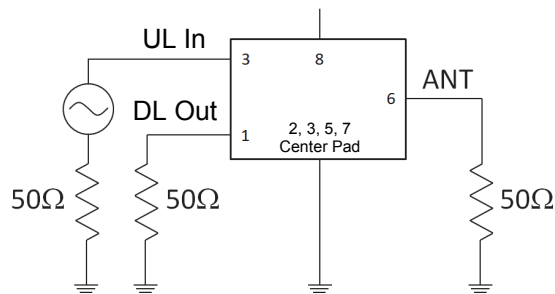

Pin 8 can be connected to ground or left floating

Downlink Performance Plots - TQM963001-PCB Temp=25°C

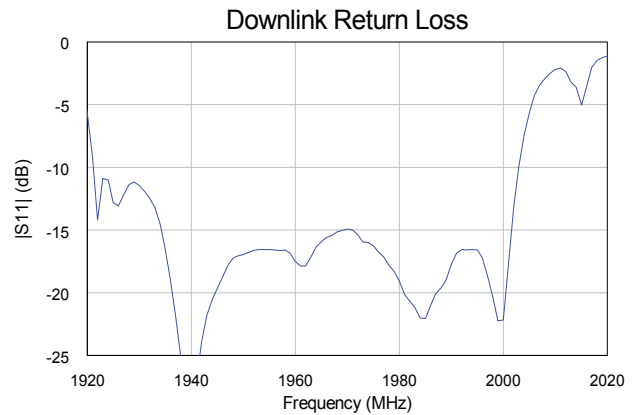
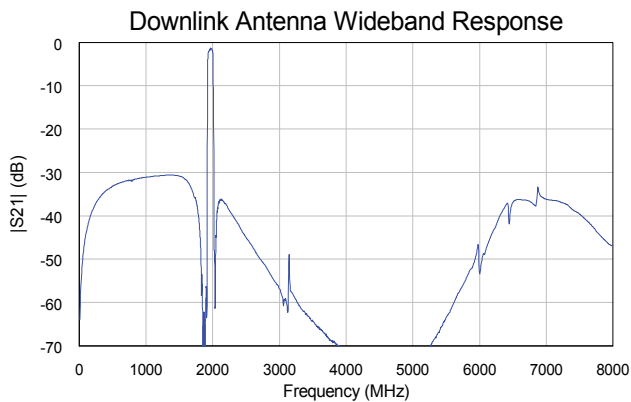
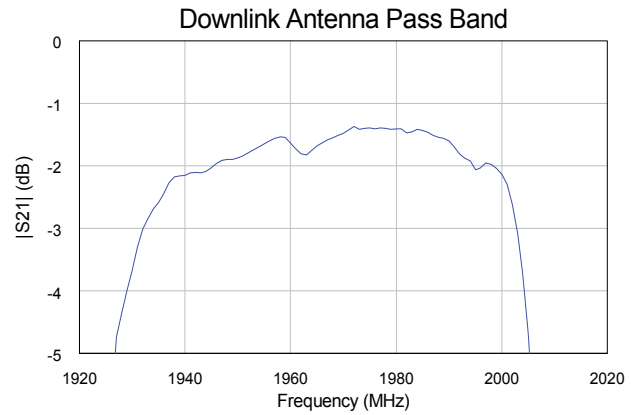
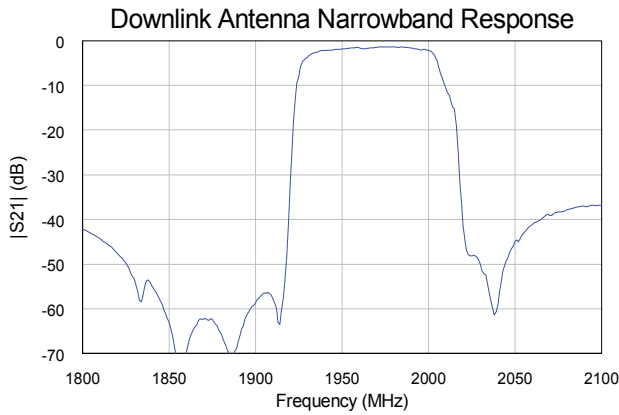

Downlink Impedance in Downlink Band

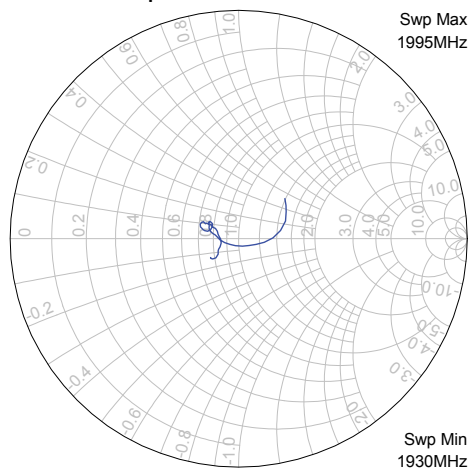

Antenna Impedance in Downlink Band

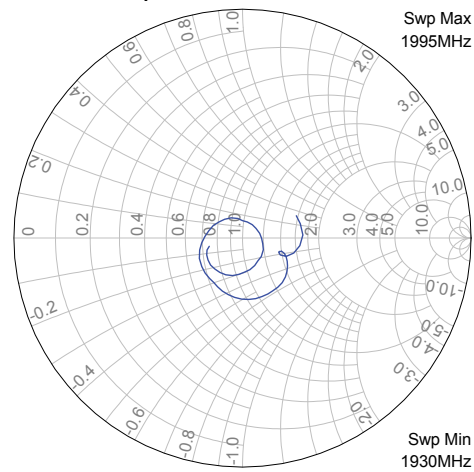

Uplink Performance Plots – TQM963001-PCB Temp=25°C

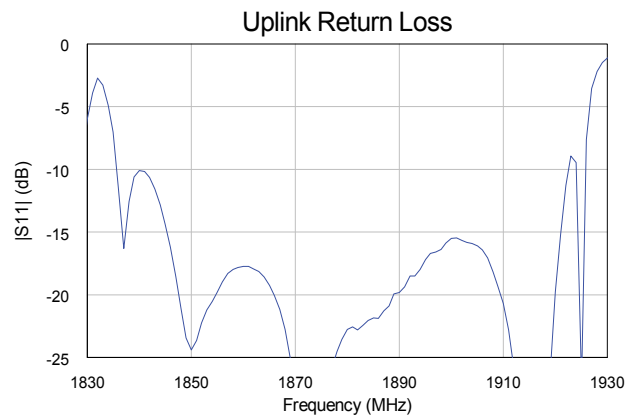
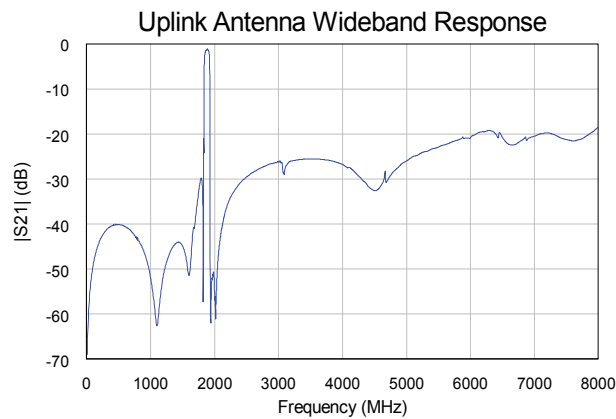
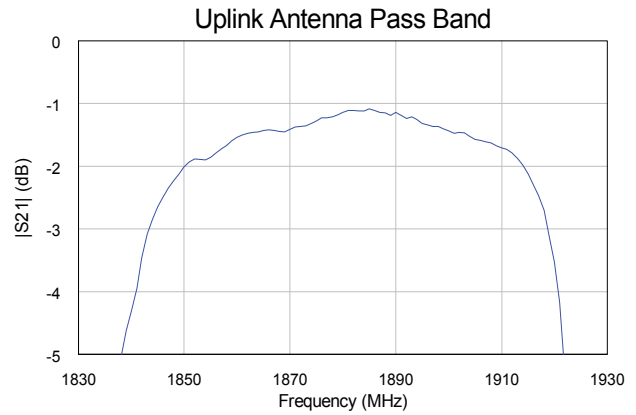
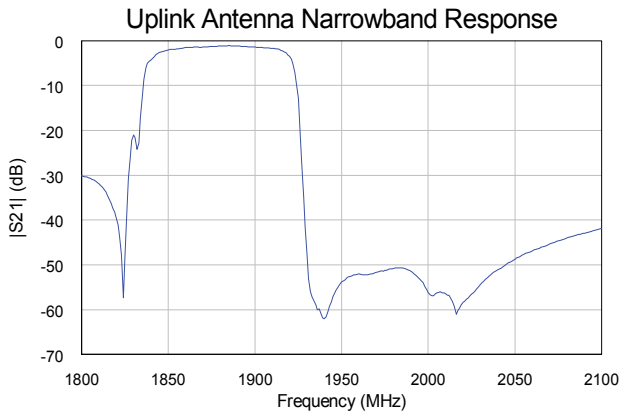

Uplink Impedance in Uplink Band

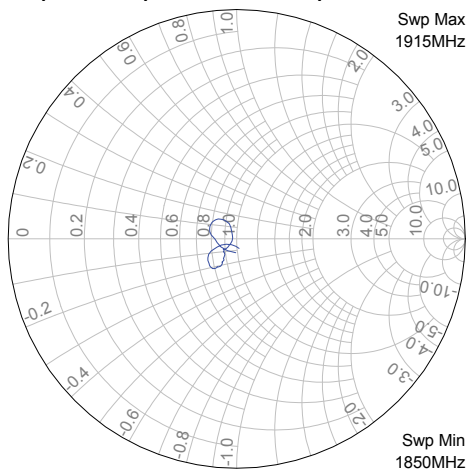

Antenna Impedance in Uplink Band

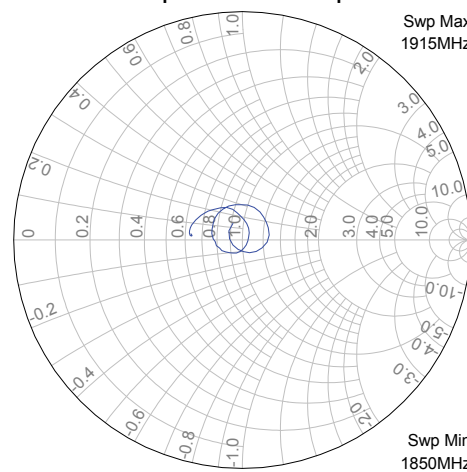

Isolation/Antenna Return Loss – TQM963001-PCB Temp=25°C

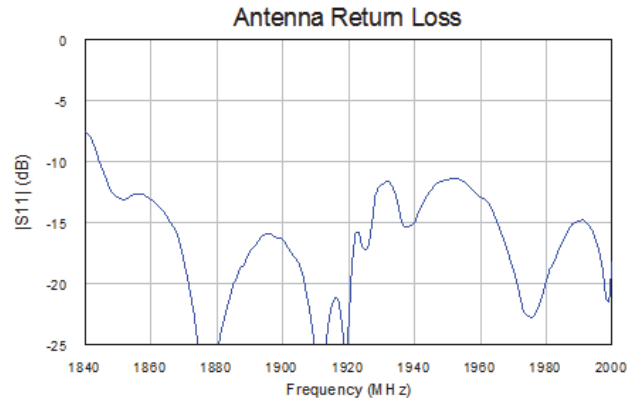
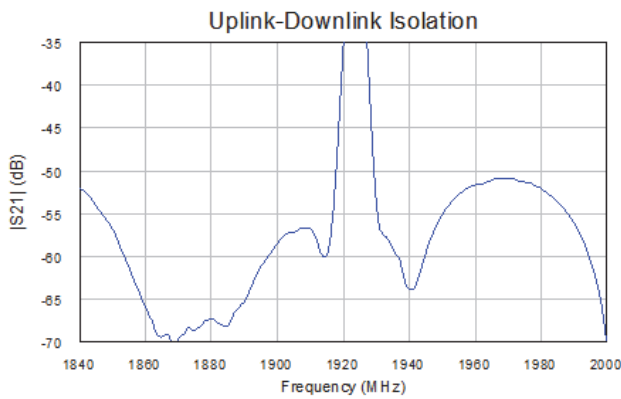

Pin Configuration and Description

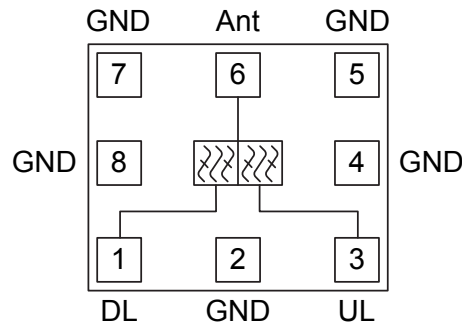

Pin No.	Symbol	Description
1	DL	Downlink input
3	UL	Uplink output
6	Ant	Antenna port
8	GND	Internally connected to ground, but no external connection required.
2, 4, 5, 7, Center Pad	GND	RF ground

Mechanical Information

Package Marking and Dimensions

Marking: Part number – 3001
 Lot Code – XXXX

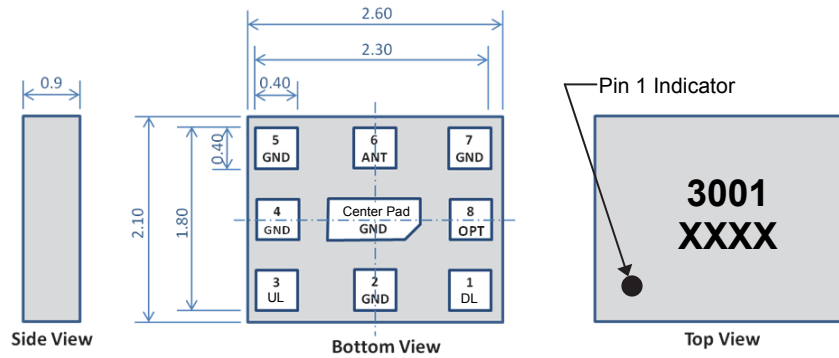

NOTES:

1. All dimensions are in millimeters. Angles are in degrees.
2. Except where noted, this part outline conforms to JEDEC standard MO-220, Issue E (Variation VGGC) for thermally enhanced plastic very thin fine pitch quad flat no lead package (QFN).
3. Dimension and tolerance formats conform to ASME Y14.4M-1994.
4. The terminal #1 identifier and terminal numbering conform to JESD 95-1 SPP-012.

PCB Mounting Pattern

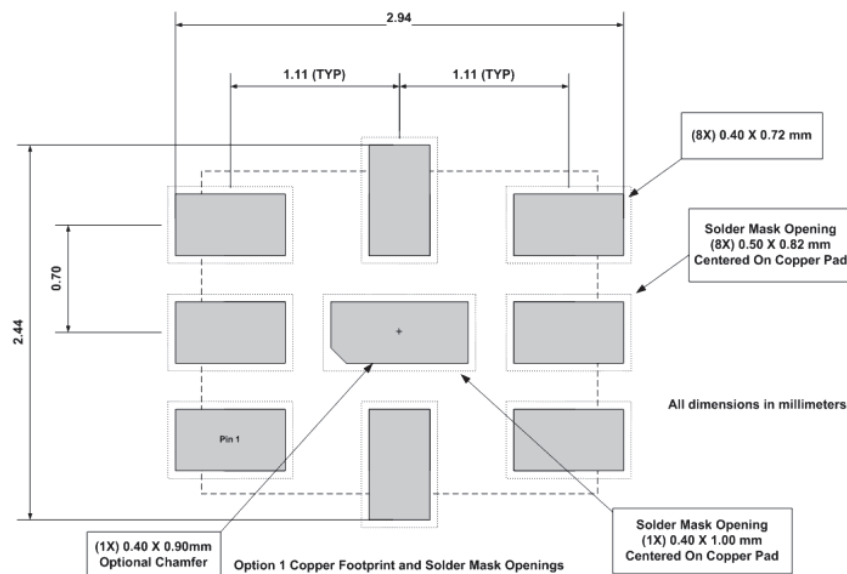

NOTES:

1. All dimensions are in millimeters. Angles are in degrees.
2. Use 1 oz. copper minimum for top and bottom layer metal.
3. Vias are required under the TBD of this device for proper RF/DC grounding and thermal dissipation. We recommend a 0.35mm (#80/.0135") diameter bit for drilling via holes and a final plated thru diameter of 0.25 mm (0.10").
4. Ensure good package backside paddle solder attach for reliable operation and best electrical performance.

Product Compliance Information

ESD Sensitivity Ratings



Caution! ESD-Sensitive Device

ESD Rating: Class 1B
Value: ≥ 500 V to < 1000 V
Test: Human Body Model (HBM)
Standard: ESDA/JEDEC Standard JS-001-2012

ESD Rating: Class B
Value: > 200 V to < 400 V
Test: Machine Model (MM)
Standard: JEDEC Standard JESD22-A115-A

MSL Rating

MSL Rating: Level 3
Test: 260 °C convection reflow
Standard: JEDEC Standard IPC/JEDEC J-STD-020

Solderability

Compatible with both lead-free (260 °C max. reflow temperature) and tin/lead (245 °C max. reflow temperature) soldering processes.

Package contact plating: Ni/Au

RoHS Compliance

This part is compliant with EU 2002/95/EC RoHS directive (Restrictions on the Use of Certain Hazardous Substances in Electrical and Electronic Equipment).

This product also has the following attributes:

- Lead Free
- Halogen Free (Chlorine, Bromine)
- Antimony Free
- TBBP-A ($C_{15}H_{12}Br_4O_2$) Free
- PFOS Free
- SVHC Free

Contact Information

For the latest specifications, additional product information, worldwide sales and distribution locations, and information about TriQuint:

Web: www.triquint.com **Tel:** +1.407.886.8860
Email: info-sales@triquint.com **Fax:** +1.407.886.7061

For technical questions and application information:

Email: sjcappplications.engineering@triquint.com

Important Notice

The information contained herein is believed to be reliable. TriQuint makes no warranties regarding the information contained herein. TriQuint assumes no responsibility or liability whatsoever for any of the information contained herein. TriQuint assumes no responsibility or liability whatsoever for the use of the information contained herein. The information contained herein is provided "AS IS, WHERE IS" and with all faults, and the entire risk associated with such information is entirely with the user. All information contained herein is subject to change without notice. Customers should obtain and verify the latest relevant information before placing orders for TriQuint products. The information contained herein or any use of such information does not grant, explicitly or implicitly, to any party any patent rights, licenses, or any other intellectual property rights, whether with regard to such information itself or anything described by such information.

TriQuint products are not warranted or authorized for use as critical components in medical, life-saving, or life-sustaining applications, or other applications where a failure would reasonably be expected to cause severe personal injury or death.

X-ON Electronics

Largest Supplier of Electrical and Electronic Components

Click to view similar products for [Signal Conditioning](#) category:

Click to view products by [Qorvo](#) manufacturer:

Other Similar products are found below :

[MAPDCC0001](#) [MAPDCC0004](#) [PD0409J5050S2HF](#) [880157](#) [HHS-109-PIN](#) [DC1417J5005AHF](#) [AFS14A30-2185.00-T3](#) [AFS14A35-1591.50-T3](#) [DS-323-PIN](#) [B39321R801H210](#) [1A0220-3](#) [JP510S](#) [LFB212G45SG8C341](#) [LFB322G45SN1A504](#) [LFL182G45TC3B746](#) [SF2159E](#) [30057](#) [FM-104-PIN](#) [CER0813B](#) [MAPDCC0005](#) [3A325](#) [40287](#) [41180](#) [ATB3225-75032NCT](#) [BD0810N50100AHF](#) [BD2425J50200AHF](#) [C5060J5003AHF](#) [JHS-115-PIN](#) [JP503AS](#) [DC0710J5005AHF](#) [DC2327J5005AHF](#) [DC3338J5005AHF](#) [43020](#) [LFB2H2G60BB1C106](#) [LFL15869MTC1B787](#) [X3C19F1-20S](#) [XC3500P-20S](#) [10013-20](#) [SF2194E](#) [CDBLB455KCAX39-B0](#) [TGL2208-SM, EVAL](#) [RF1353C](#) [PD0922J5050D2HF](#) [1E1305-3](#) [1F1304-3S](#) [1G1304-30](#) [B0922J7575AHF](#) [2020-6622-20](#) [TP-103-PIN](#) [BD1222J50200AHF](#)