

General Description

The TQP9221 is a high-linearity two-stage power amplifier in a low-cost surface-mount package with on-chip bias control and temperature compensation circuits. The amplifier provides 30.5 dB gain over the 2010 – 2200 MHz frequency range and be utilized without the need of linearization circuitry such as DPD. It is able to achieve -49 dBc ACLR at +24 dBm output power using 20 MHz LTE signal (9.5 dB PAR).

The TQP9221 integrates two high performance amplifier stages onto a module to allow for a compact system design and requires very few external components for operation. The product is bias adjustable allowing the amplifier's power consumption to be optimized and is available in a lead-free/RoHS-compliant 7 x 7 mm surface mount package.

The TQP9221 is targeted for small cell or enterprise Femtocell basestation applications, distributed antenna systems (DAS), repeaters, and/or booster amplifiers.

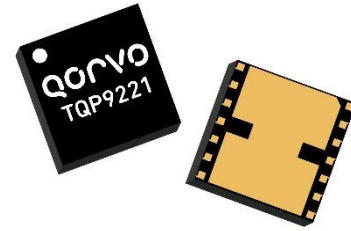

14 Pin 7 x 7 mm Leadless SMT Package

Product Features

- 2010 – 2200 MHz Frequency Range
- Fully integrated, 2-Stage Power Amplifier
- Internally Matched 50 Ω Input & Output
- -49 dBc ACLR at Pavg = +24 dBm
- 30.5 dB Gain
- 15% PAE at +24 dBm
- 220 mA Quiescent Current
- On-chip Control Bias and Temp. Comp Circuit
- RoHS compliant
- Covers Bands 1, 4, 10, 23, 34, 66

Functional Block Diagram

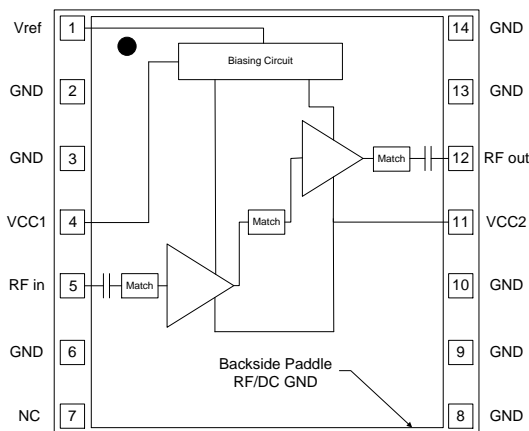

Top View

Applications

- Small Cell / Picocell
- Enterprise Femtocell
- Customer Premises Equipment (CPE)
- Data Cards and Terminals
- Distributed Antenna Systems (DAS)
- Booster Amps, Repeater

Ordering Information

Part No.	Description
TQP9221	2,500 pieces on a 13" reel (standard)
TQP9221-PCB	2.11 –2.17 GHz Evaluation Board

Absolute Maximum Ratings

Parameter	Rating
Storage Temperature	-55 to +150 °C
RF Input Power, CW, 50Ω, T=+25 °C	+13 dBm
Supply Voltage (V _{CC})	6 V
V _{REF}	+3.5 V

Exceeding any one or a combination of the Absolute Maximum Rating conditions may cause permanent damage to the device. Extended application of Absolute Maximum Rating conditions to the device may reduce device reliability.

Recommended Operating Conditions

Parameter	Min	Typ	Max	Units
V _{CC1} , V _{CC2}	+3.6	+4.5	+5.25	V
V _{ref}	+2.75	+2.85	+2.95	V
T _{CASE}	-40		+85	°C
T _j at T _{CASE} max			+165	°C

Electrical specifications are measured at specified test conditions. Specifications are not guaranteed over all recommended operating conditions.

Electrical Specifications

Parameter	Conditions ⁽¹⁾	Min	Typ	Max	Units
Frequency Range		2010		2200	MHz
Test Frequency			2140		MHz
Gain		27.5	30.5	34.5	dB
Input Return Loss		7	10		dB
Output Return Loss		9	12		dB
Output P1dB			+33		dBm
ACLR	P _{out} = +24 dBm, 20 MHz LTE E-TM1.1, 9.5 dB PAR		-49	-45	dBc
ACLR	P _{out} = +24 dBm, 2X20 MHz LTE E-TM1.1, 9.5 dB PAR		-43		dBc
ACLR	P _{out} = +24 dBm, 15 MHz LTE E-TM1.1, 9.5 dB PAR		-51		dBc
ACLR	P _{out} = +24 dBm, 10 MHz LTE E-TM1.1, 9.5 dB PAR		-51		dBc
ACLR	P _{out} = +24 dBm, 5 MHz LTE E-TM1.1, 9.5 dB PAR		-51		dBc
Power Added Efficiency	P _{out} = +24 dBm, 20 MHz LTE E-TM1.1, 9.5 dB PAR	13	15.2		%
Spurious Output Level	P _{out} = +24 dBm, 10:1 VSWR		<60		dBc
VSWR Survivability	No degradation or failure	10:1			VSWR
Quiescent Current	V _{CC1} + V _{CC2}	160	220	280	mA
Reference Current	Temp = -40°C to +85°C, V _{REF} = +2.85V		6.5	10	mA
Leakage current	V _{CC} = +4.5V, V _{ref} = 0V		1.5	5	μA
Operational Current	P _{out} = +24 dBm		365	460	mA
Switching Time	10% to 90% Rise time		620		nSec
	90% to 10% Fall time		840		nSec
Harmonics	2F ₀ at +24dBm, CW signal		-37	-32	dBc
	3F ₀ at +24dBm, CW signal		-52	-47	dBc
	4F ₀ at +24dBm, CW signal		-60	-55	dBc
Thermal Resistance, θ _{JC}	Module (junction to case)			37	°C/W

Notes:

1. Test conditions unless otherwise noted: V_{CC1} = V_{CC2} = +4.5V, V_{REF} = +2.85V, Temp = +25 °C, 50 Ω system.

Evaluation Board – TQP9221-PCB

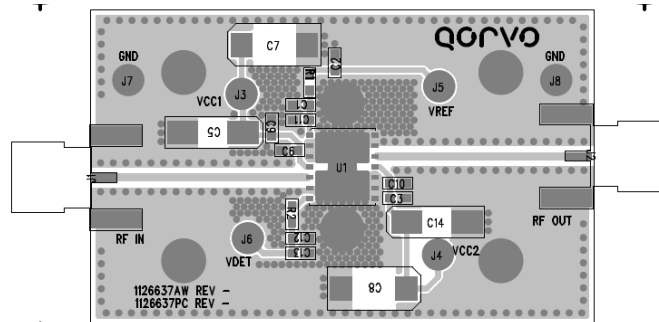
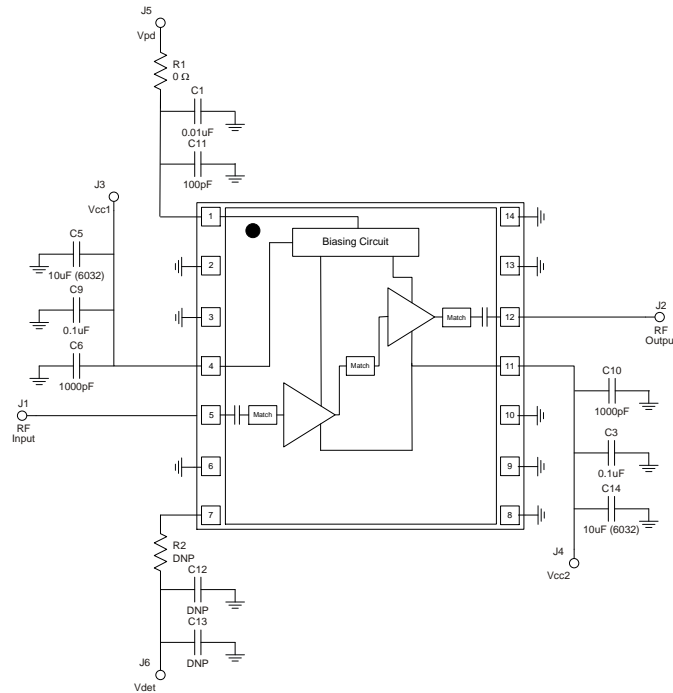

Bill of Material – TQP9221-PCB

Reference Des.	Value	Description	Manuf.	Part Number
-	-	Printed Circuit Board	Qorvo	1126637
U1	-	High Linearity 0.25 W Power Amplifier	Qorvo	TQP9221
R1	0 Ω	Resistor, Chip, 0603, 5%	various	
C1	0.01 μF	Capacitor, Chip, 0603, 5%	various	
C11	100 pF	Capacitor, Chip, 0603, 5%	various	
C3, C9	0.1 μF	Capacitor, Chip, 0603, 5%	various	
C5, C14	10 μF	Capacitor, Chip, 6032, 10%, Tantalum	various	
C6, C10	1000 pF	Capacitor, Chip, 0603, NPO/COG, 5%	various	

Typical Performance

Parameter	Conditions	-40°C	+25°C	+85°C	Units
Gain	Small Signal	32	30.5	29.0	dB
ACLR	P _{OUT} = +24 dBm, 20 MHz LTE E-TM1.1, 9.5dB PAR	-51	-49	-47	dBc
PAE	P _{OUT} = +24 dBm, 20 MHz LTE E-TM1.1, 9.5dB PAR	16	15	14	%

Test Frequency = 2140MHz

LTE signal BW	5MHz	10MHz	15MHz	20MHz	Units
ACLR1-Low	-50.0	-50.5	-50.5	-50.0	dBc
ACLR1-high	-50.0	-50.0	-50.0	-50.0	dBc

V_{CC1}=V_{CC2}=4.5V, P_{out}=24.5dBm, Signal PAR=9.5dB, F = 2140MHz

Performance Plots – TQP9221-PCB

Test conditions unless otherwise noted: V_{CC1} = V_{CC2} = +4.5V, V_{REF} = +2.85V, I_{CQ} = 220mA, I_{REF} = 6.5mA, Temp. = +25°C

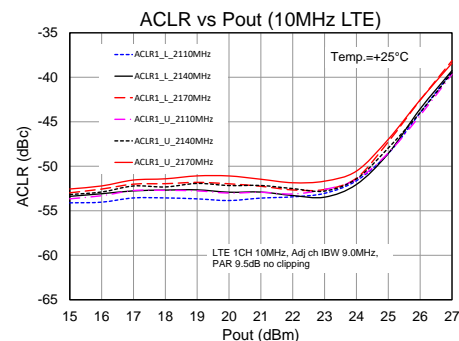
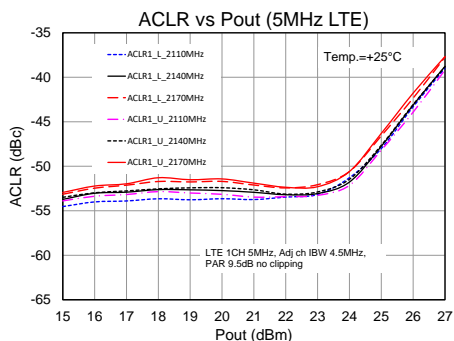
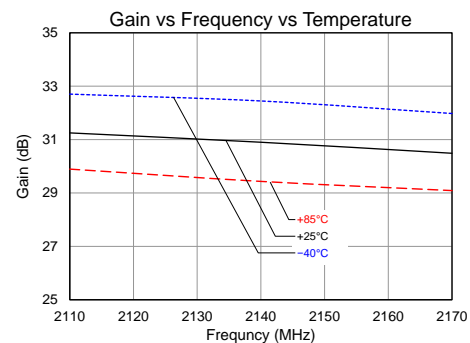
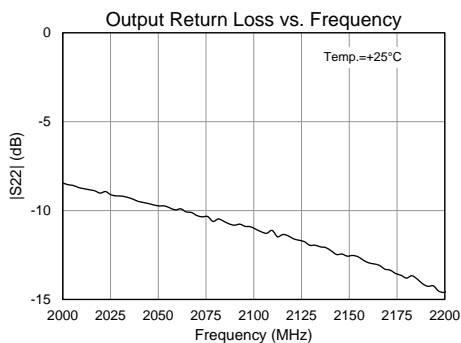
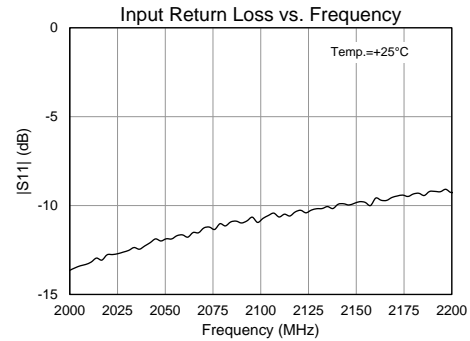
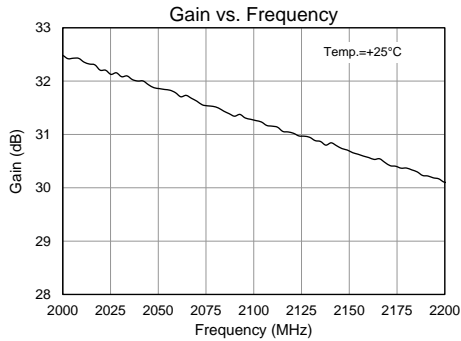

Performance Plots – TQP9221-PCB

Test conditions unless otherwise noted: $V_{CC1} = V_{CC2} = +4.5V$, $V_{REF} = +2.85V$, $I_{CQ} = 220mA$, $I_{REF} = 6.5mA$, $Temp. = +25^\circ C$

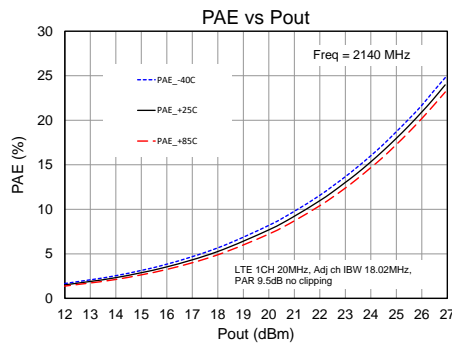
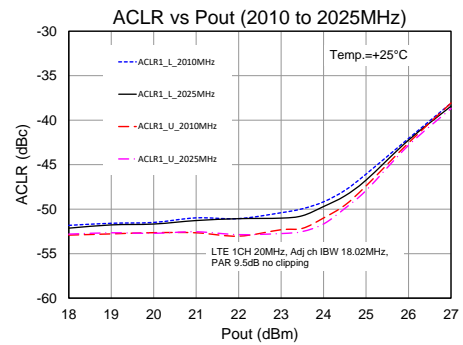
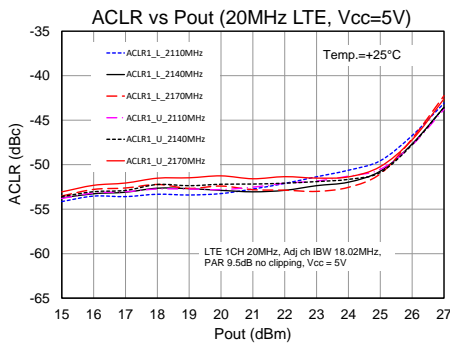
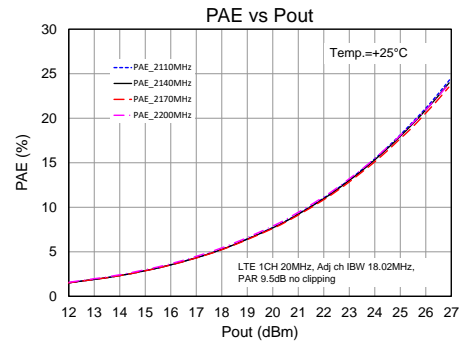
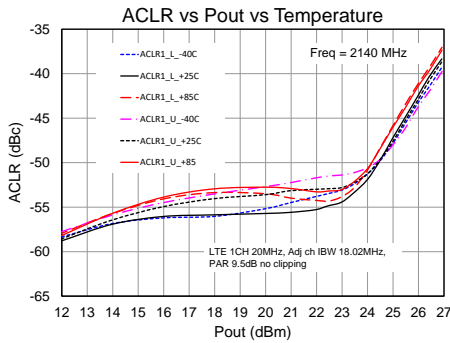
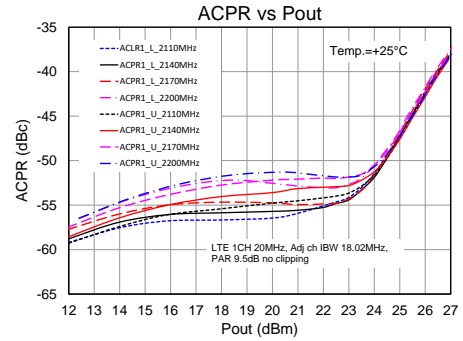
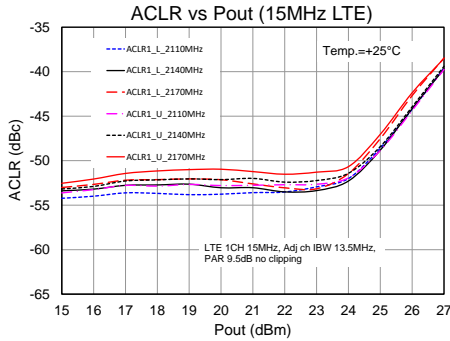

Switching Time

Switching Time Measurement based on TQP9221 Application Board

Using Shutdown Circuit: $V_{REF}=2.85V$, $V_{CC}=4.5V$, $C_1=NL$

Parameter	
Turn-on Transition (10% RF – 90% RF)	620ns
Turn-off Transition (90% RF – 10% RF)	840ns

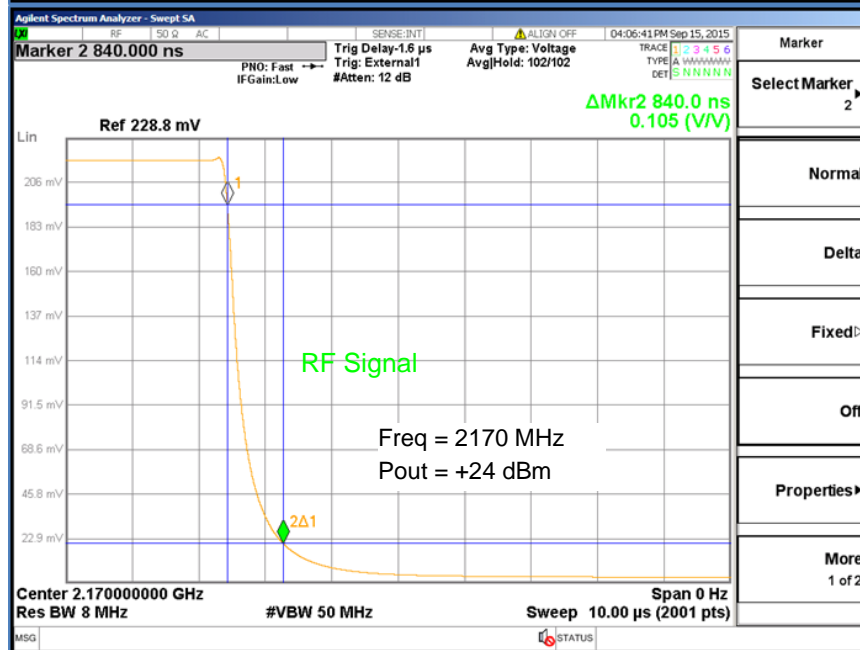
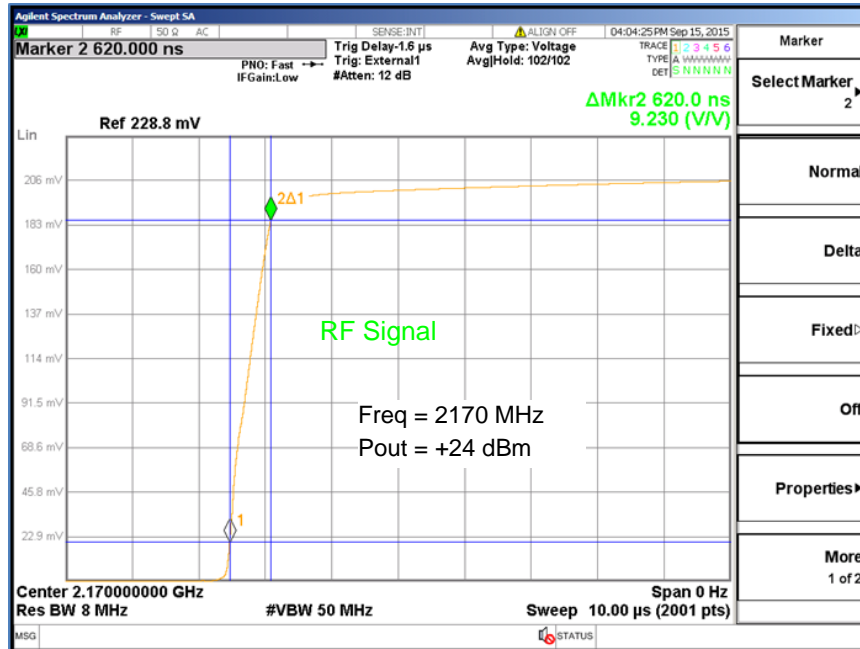

Pin Configuration and Description

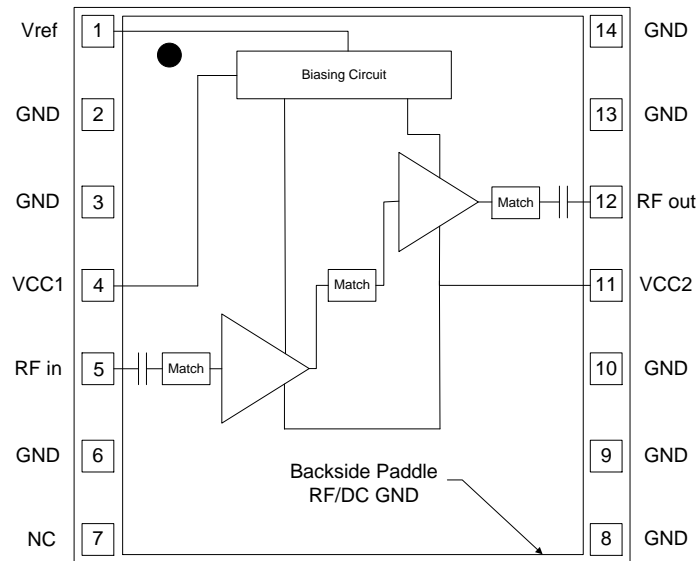

Top View

Pad No.	Label	Description
1	V _{REF}	Sets the bias current for the amplifiers. It can also be used to power down the device.
2, 3, 6, 8, 9, 10, 13, 14	GND	RF and DC ground.
4	VCC1	Voltage supply for the active bias circuitry.
5	RF in	RF input pin. The DC is internally blocked at this pin.
7	NC	No internal connection.
11	VCC2	DC voltage supply connection for AMP1 and AMP2.
12	RF out	RF output pin. The DC is internally blocked at this pin.
Backside Paddle	RF/DC GND	RF/DC ground. See PCB Mounting Pattern for suggested footprint.

Evaluation Board PCB Information

Qorvo PCB 1126637 Material and Stack-up

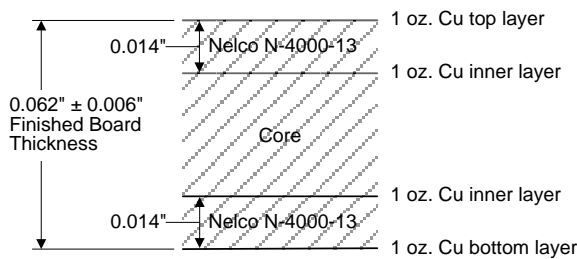

50 Ω line dimensions: width = .028"
spacing = .028".

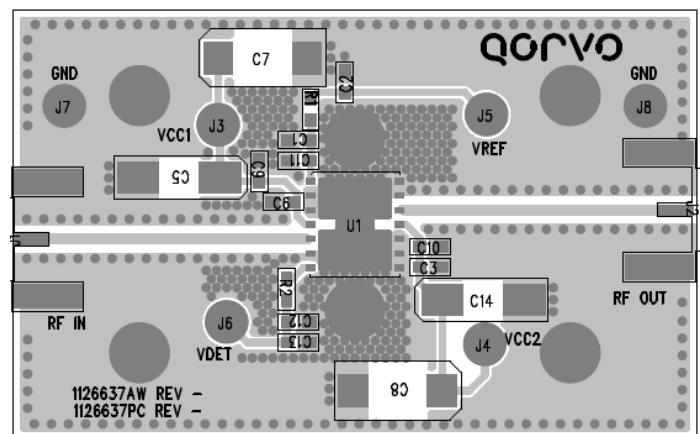

Package Marking and Dimensions

Marking: Part number – TQP9221
 Assembly Code – YYWW
 Country Code - CCCC
 Lot code – AaXXXX

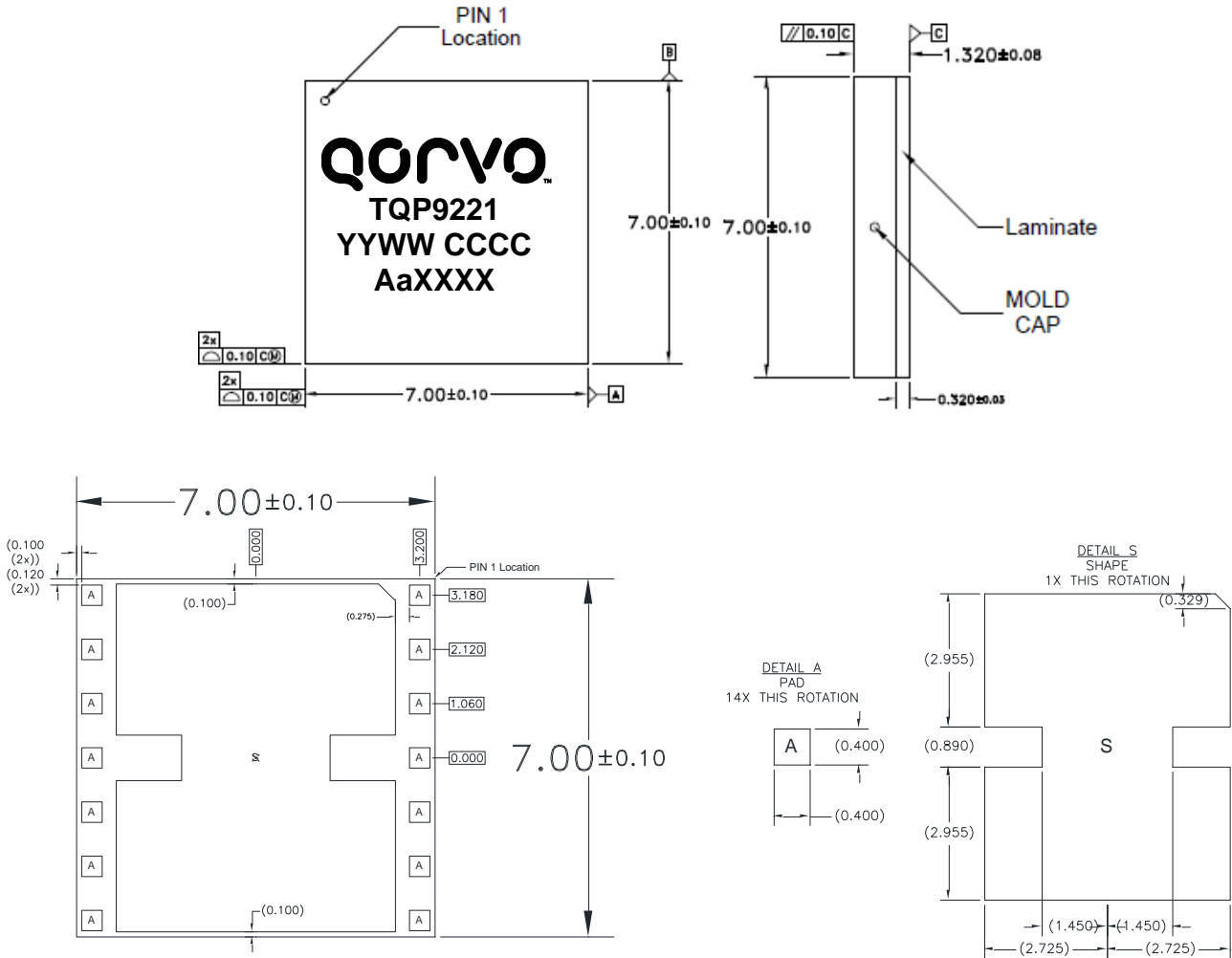

Notes:

1. All dimensions are in millimeters. Angles are in degrees.
2. Dimension and tolerance formats conform to ASME Y14.4M-1994.
3. The terminal #1 identifier and terminal numbering conform to JESD 95-1 SPP-012.

PCB Mounting Pattern

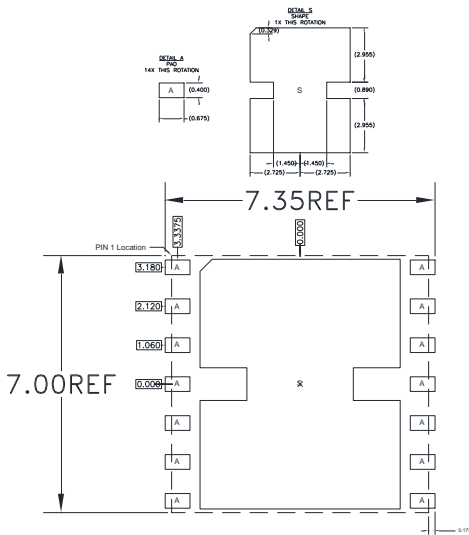

RECOMMENDED
LAND PATTERN

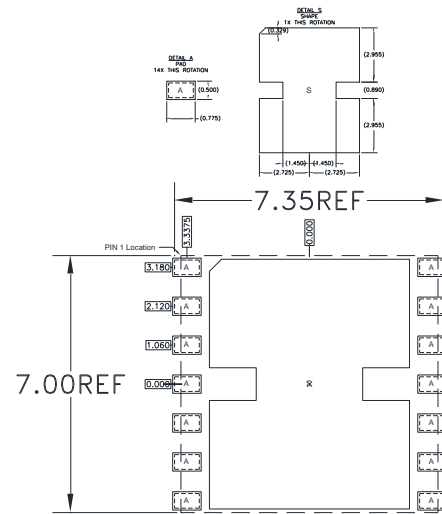

RECOMMENDED
LAND PATTERN MASK

Notes:

1. All dimensions are in millimeters. Angles are in degrees.
2. Use 1 oz. copper minimum for top and bottom layer metal.
3. Via holes are required under the backside paddle of this device for proper RF/DC grounding and thermal dissipation. We recommend a 0.35mm (#80/.0135") diameter bit for drilling via holes and a final plated thru diameter of 0.25 mm (0.010").
4. Ensure good package backside paddle solder attach for reliable operation and best electrical performance.

Tape and Reel Information – Carrier and Cover Tape Dimensions

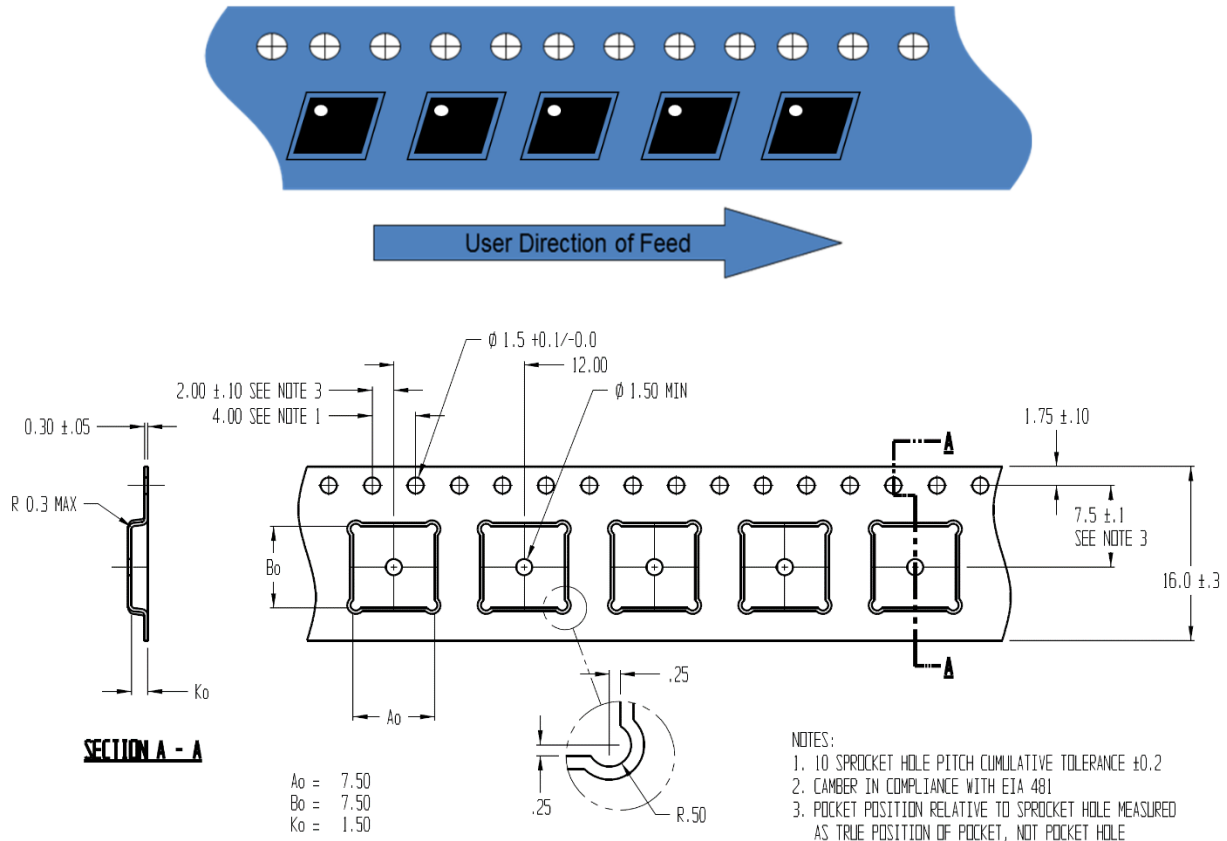

Feature	Measure	Symbol	Size (in)	Size (mm)
Cavity	Length	A0	0.295	7.50
	Width	B0	0.295	7.50
	Depth	K0	0.059	1.50
	Pitch	P1	0.472	12.00
Centerline Distance	Cavity to Perforation - Length Direction	P2	0.079	2.00
	Cavity to Perforation - Width Direction	F	0.295	7.50
Cover Tape	Width	C	0.524	13.30
Carrier Tape	Width	W	0.630	16.0

Tape and Reel Information – Reel Dimensions (13")

Standard T/R size = 2,500 pieces on a 13" reel.

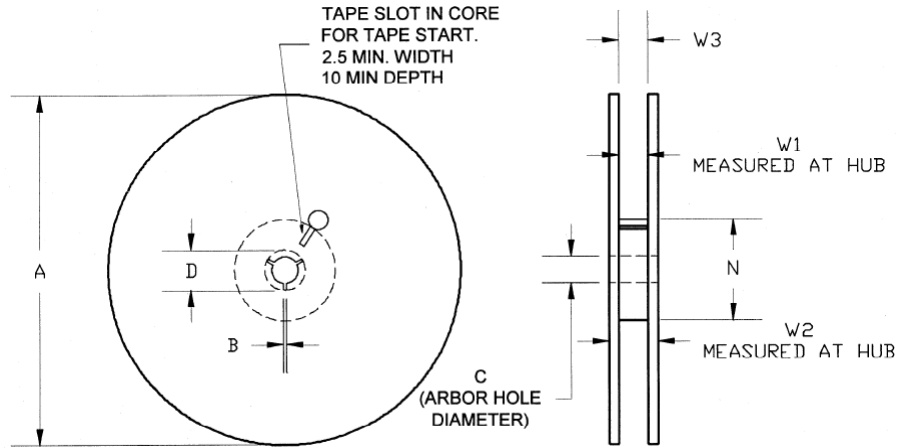

Feature	Measure	Symbol	Size (in)	Size (mm)
Flange	Diameter	A	12.992	330.0
	Thickness	W2	0.874	22.2
	Space Between Flange	W1	0.661	16.8
Hub	Outer Diameter	N	4.016	102.0
	Arbor Hole Diameter	C	0.512	13.0
	Key Slit Width	B	0.079	2.0
	Key Slit Diameter	D	0.787	20.0

Tape and Reel Information – Tape Length and Label Placement

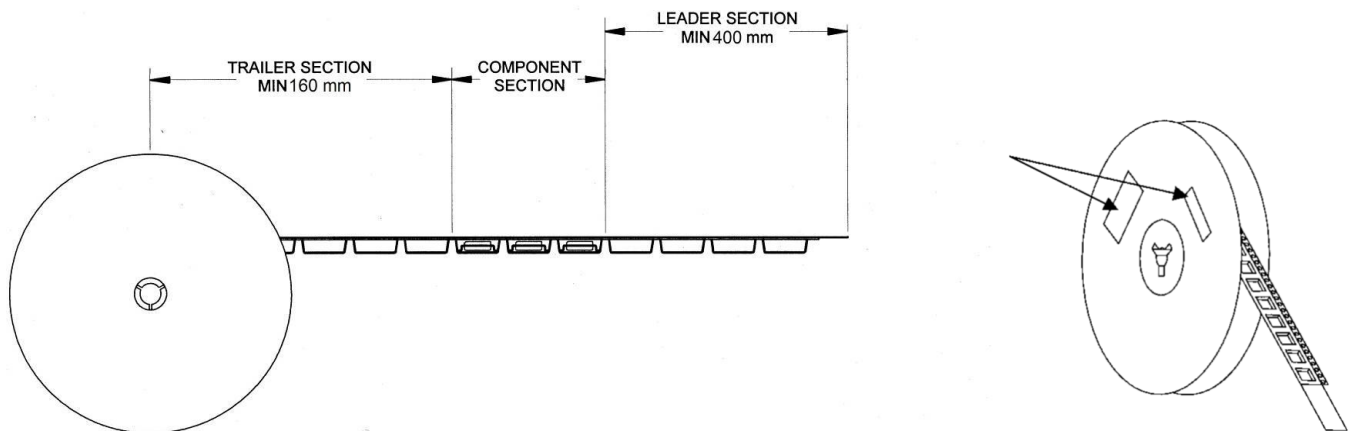

Notes:

1. Empty part cavities at the trailing and leading ends are sealed with cover tape. See EIA 481-1-A.
2. Labels are placed on the flange opposite the sprockets in the carrier tape.

Handling Precautions

Parameter	Rating	Standard
ESD – Human Body Model (HBM)	Class 2	ESDA / JEDEC JS-001-2012
ESD – Charged Device Model (CDM)	Class C3	JEDEC JESD22-C101F
MSL – Moisture Sensitivity Level	Level 3	IPC/JEDEC J-STD-020



Caution!
ESD-Sensitive Device

Solderability

Compatible with both lead-free (260°C max. reflow temp.) and tin/lead (245°C max. reflow temp.) soldering processes.

Solder profiles available upon request.

Contact plating: Electrolytic plated Au over Ni

RoHS Compliance

This part is compliant with 2011/65/EU RoHS directive (Restrictions on the Use of Certain Hazardous Substances in Electrical and Electronic Equipment) as amended by Directive 2015/863/EU. This product also has the following attributes:

- Product uses RoHS Exemption 7c-I to meet RoHS Compliance requirements
- Halogen Free (Chlorine, Bromine)
- Antimony Free
- TBBP-A (C₁₅H₁₂Br₄O₂) Free
- PFOS Free

Contact Information

For the latest specifications, additional product information, worldwide sales and distribution locations:

Tel: **1-844-890-8163**

Web: www.qorvo.com

Email: customer.support@qorvo.com

Important Notice

The information contained herein is believed to be reliable; however, Qorvo makes no warranties regarding the information contained herein and assumes no responsibility or liability whatsoever for the use of the information contained herein. All information contained herein is subject to change without notice. Customers should obtain and verify the latest relevant information before placing orders for Qorvo products. The information contained herein or any use of such information does not grant, explicitly or implicitly, to any party any patent rights, licenses, or any other intellectual property rights, whether with regard to such information itself or anything described by such information. **THIS INFORMATION DOES NOT CONSTITUTE A WARRANTY WITH RESPECT TO THE PRODUCTS DESCRIBED HEREIN, AND QORVO HEREBY DISCLAIMS ANY AND ALL WARRANTIES WITH RESPECT TO SUCH PRODUCTS WHETHER EXPRESS OR IMPLIED BY LAW, COURSE OF DEALING, COURSE OF PERFORMANCE, USAGE OF TRADE OR OTHERWISE, INCLUDING THE IMPLIED WARRANTIES OF MERCHANTABILITY AND FITNESS FOR A PARTICULAR PURPOSE.**

Without limiting the generality of the foregoing, Qorvo products are not warranted or authorized for use as critical components in medical, life-saving, or life-sustaining applications, or other applications where a failure would reasonably be expected to cause severe personal injury or death.

Copyright 2019 © Qorvo, Inc. | Qorvo is a registered trademark of Qorvo, Inc.

X-ON Electronics

Largest Supplier of Electrical and Electronic Components

Click to view similar products for [RF Amplifier](#) category:

Click to view products by [Qorvo](#) manufacturer:

Other Similar products are found below :

[A82-1](#) [BGA622H6820XTSA1](#) [BGA 728L7 E6327](#) [BGB719N7ESDE6327XTMA1](#) [HMC397-SX](#) [HMC405](#) [HMC561-SX](#) [HMC8120-SX](#)
[HMC8121-SX](#) [HMC-ALH382-SX](#) [HMC-ALH476-SX](#) [SE2433T-R](#) [SMA3101-TL-E](#) [SMA39](#) [A66-1](#) [A66-3](#) [A67-1](#) [A81-2](#) [LX5535LQ](#)
[LX5540LL](#) [MAAM02350](#) [HMC3653LP3BETR](#) [HMC549MS8GETR](#) [HMC-ALH435-SX](#) [SMA101](#) [SMA32](#) [SMA411](#) [SMA531](#)
[SST12LP19E-QX6E](#) [WPM0510A](#) [HMC5929LS6TR](#) [HMC5879LS7TR](#) [HMC1126](#) [HMC1087F10](#) [HMC1086](#) [HMC1016](#) [SMA1212](#)
[MAX2689EWS+T](#) [MAAMSS0041TR](#) [MAAM37000-A1G](#) [LTC6430AIUF-15#PBF](#) [SMA70-2](#) [SMA4011](#) [A231](#) [HMC-AUH232](#) [LX5511LQ](#)
[LX5511LQ-TR](#) [HMC7441-SX](#) [HMC-ALH310](#) [XD1001-BD-000V](#)