

### General Description

The TQP9424 is a high-linearity three-stage power amplifier in a low-cost surface-mount package with on-chip bias control and temperature control circuits, suitable for small cell base station applications.

The TQP9424 provides 36.3 dB gain and +27 dBm linear power over the 2.3–2.4 GHz frequency range covering bands 30 and 40. This amplifier is able to achieve -47 dBc ACLR at +27 dBm output power using a 20 MHz LTE signal.

The TQP9424 integrates three high performance amplifier stages onto a module to allow for a compact system design and requires very few external components for operation. The amplifier is bias adjustable allowing the amplifier's power consumption to be optimized. The TQP9424 is available in a lead-free/RoHS-compliant 7 x 7 mm surface mount package.

### Functional Block Diagram

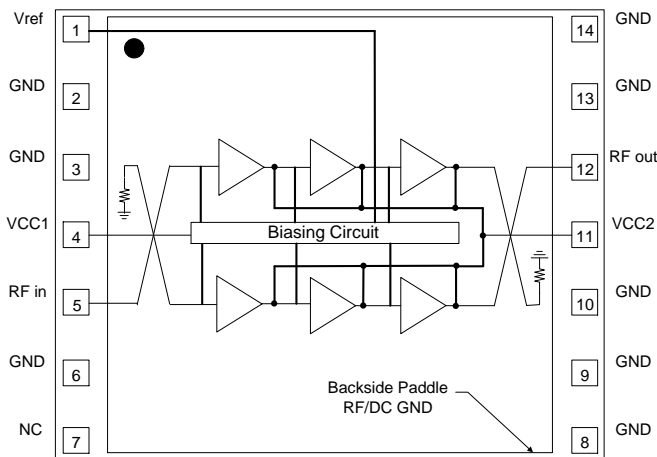

Top View

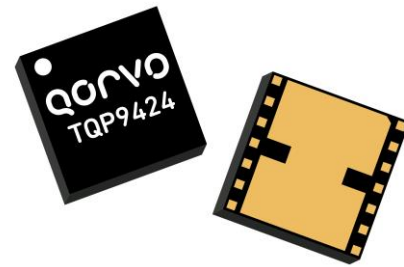

7 x 7 mm Leadless SMT Package

### Product Features

- 2.3 – 2.4 GHz Operating Frequency Range
- Fully integrated, 3-Stage Power Amplifier
- Internally Matched 50 Ω Input/Output
- -47 dBc ACLR at Pavg = +27 dBm
- 36.3 dB Gain
- 14% PAE at +27 dBm
- 470 mA Quiescent Current
- On-chip Control Bias and Temp. Comp Circuit
- Lead-free / RoHS compliant

### Applications

- Small Cell / Picocell
- Bands 30 & 40
- Enterprise Femtocell
- Customer Premises Equipment (CPE)
- Data Cards and Terminals
- Distributed Antenna Systems (DAS)
- Booster Amps, Repeaters

### Ordering Information

Part No.	Description
TQP9424SR	7" reel with 100pcs
TQP9424TR13	2,500 pieces on a 13" reel (standard)
TQP9424PCB401	2.3–2.4 GHz Evaluation Board

### Absolute Maximum Ratings

Parameter	Rating
Storage Temperature	-55 to +150 °C
Supply Voltage (V <sub>CC</sub> )	+6 V
V <sub>ref</sub>	+3.5 V
RF Input Power, CW, 50Ω, T=25°C	+13 dBm
T <sub>j</sub> at T <sub>CASE</sub> = 125°C	+196°C

Exceeding any one or a combination of the Absolute Maximum Rating conditions may cause permanent damage to the device. Extended application of Absolute Maximum Rating conditions to the device may reduce device reliability.

### Recommended Operating Conditions

Parameter	Min	Typ	Max	Units
V <sub>CC1</sub> , V <sub>CC2</sub>	+3.6	+4.5	+5.25	V
V <sub>ref</sub>	+2.75	+2.85	+2.95	V
T <sub>CASE</sub>	-40		+85	°C
T <sub>j</sub> at T <sub>CASE</sub> max			+156	°C

Electrical specifications are measured at specified test conditions. Specifications are not guaranteed over all recommended operating conditions.

### Electrical Specifications

Parameter	Conditions <sup>(1)</sup>	Min	Typ	Max	Units
Operational Frequency Range		2300		2400	MHz
Test Frequency			2350		MHz
Gain		32	35.5	38	dB
Input Return Loss		15	23		dB
Output Return Loss		15	25		dB
P1dB			35		dBm
ACLR	P <sub>OUT</sub> = +27dBm, 20 MHz LTE E-TM1.1, 9.5dB PAR		-47	-45	dBc
ACLR	P <sub>OUT</sub> = +27 dBm, 2X20 MHz LTE E-TM1.1, 9.5dB PAR		-41		dBc
Power Added Efficiency	P <sub>OUT</sub> = +27dBm, 20 MHz LTE E-TM1.1, 9.5dB PAR	13	14		%
Quiescent Current, I <sub>CC</sub> <sup>2</sup>	V <sub>CC1</sub> + V <sub>CC2</sub>	330	410	500	mA
Leakage Current	V <sub>CC</sub> = +4.5 V, V <sub>ref</sub> = 0 V		3	10	μA
Reference Current, I <sub>ref</sub>	V <sub>ref</sub> = +2.85V		15	19.5	mA
Operational Current, I <sub>CC</sub>	P <sub>out</sub> = +27 dBm		785	870	mA
Switching Speed	Rise time (10%-90%)		610		ns
	Fall time (90%-10%)		495		ns
Spurious Output Level	P <sub>out</sub> ≤ +27dBm, In & Out of band load VSWR ≤ 10:1		-60		dBc
VSWR survivability	No permanent degradation or failure	10:1			-
Harmonics	2F <sub>0</sub> (P <sub>out</sub> = 27 dBm)		-40	-35	dBc
	3F <sub>0</sub> (P <sub>out</sub> = 27 dBm)		-48	-43	dBc
	4F <sub>0</sub> (P <sub>out</sub> = 27 dBm)		-70	-65	dBc
Thermal Resistance, θ <sub>Jc</sub>	Module (junction to case)			17.4	°C/W

Notes:

1. Test conditions unless otherwise noted: V<sub>CC1</sub> = V<sub>CC2</sub> = +4.5 V, V<sub>ref</sub> = +2.85V, Temp = +25 °C, 50 Ω system.
2. Current through V<sub>CC1</sub> does not vary with power. V<sub>CC1</sub> provides the bias voltage to the current mirror circuit along with V<sub>ref</sub> to set the bias point for the whole amplifier.

Parameter	Conditions	-40°C	+25°C	+85°C	Units
Gain	Small Signal	38	36.3	34.9	dB
ACLR-L	P <sub>OUT</sub> = +27 dBm, 20 MHz LTE E-TM1.1, 9.5dB PAR	-47.5	-47	-46.7	dBc
ACLR-H	P <sub>OUT</sub> = +27 dBm, 20 MHz LTE E-TM1.1, 9.5dB PAR	-52.3	-51	-49	dBc
PAE	P <sub>OUT</sub> = +27 dBm, 20 MHz LTE E-TM1.1, 9.5dB PAR	14.8	14	13	%
P1dB		+36.8	+36.3	+35.6	dBm

Test Frequency = 2350MHz

### Evaluation Board (TQP9424-PCB)

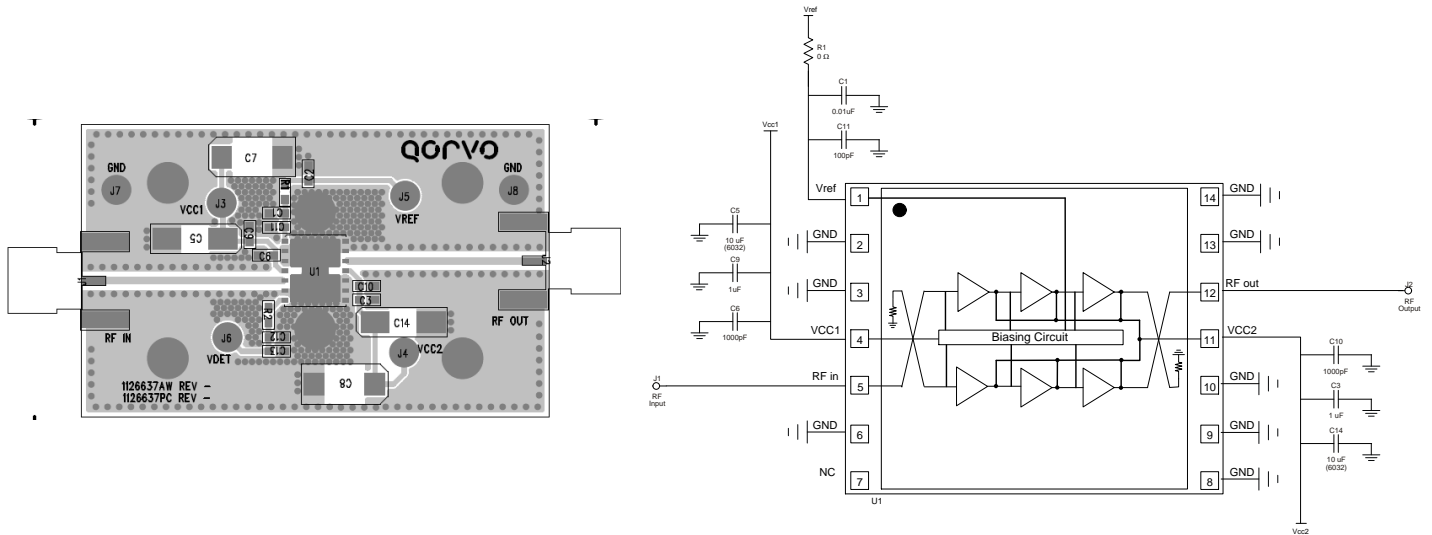

### Bill of Material – TQP9424-PCB

Reference Des.	Value	Description	Manuf.	Part Number
n/a	n/a	Printed Circuit Board		
U1	n/a	High Linearity 0.5 W Power Amplifier	Qorvo	TQP9424
R1	0 $\Omega$	Resistor, Chip, 0603, 5%	various	
C1	0.01 uF	Capacitor, Chip, 0603, 5%	various	
C11	100 pF	Capacitor, Chip, 0603, 5%	various	
C3, C9	0.1 uF	Capacitor, Chip, 0603, 5%	various	
C5, C14	10 uF	Capacitor, Chip, 6032, 10%, Tantalum	various	
C6, C10	1000 pF	Capacitor, Chip, 0603, NPO/COG, 5%	various	

### Performance Plots

Test conditions unless otherwise noted:  $V_{CC1} = V_{CC2} = +4.5V$ ,  $V_{ref} = +2.85V$ , LTE signal PAR = 9.5dB, Temp. = +25 °C

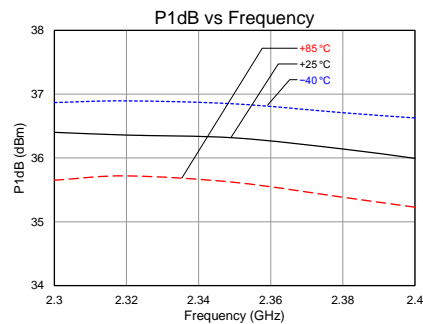
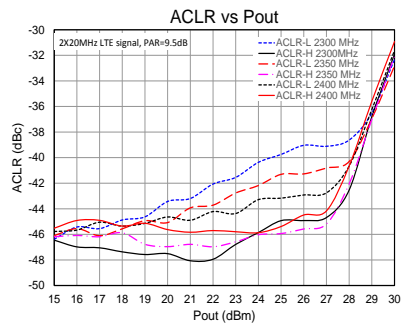
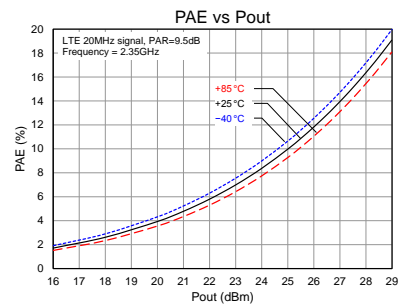
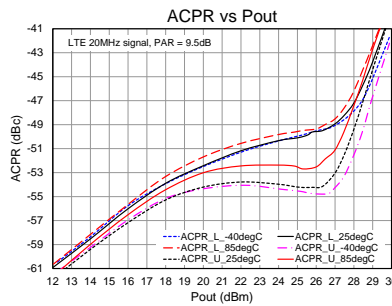
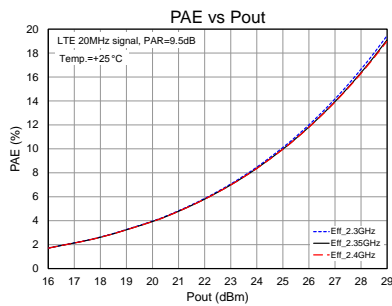
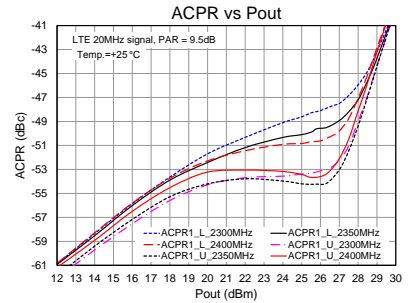
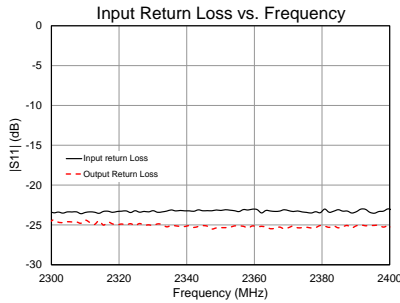
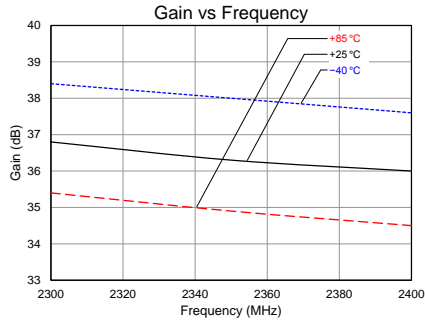

### Pin Configuration and Description

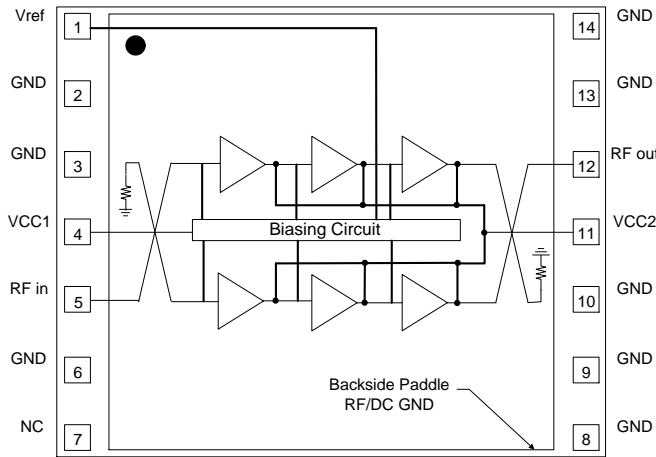

Top View

Pad No.	Label	Description
1	Vref	Provides reference voltage for internal active biasing circuit
2, 3, 6, 8, 9, 10, 13, 14	GND	RF and DC ground.
4	VCC1	Bias voltage for current mirror in combination with Vref to set the bias point.
5	RFin	RF input pin. The DC is internally blocked at this pin.
7	NC	No internal connection. Can be left open or grounded for mounting integrity.
11	VCC2	VCC supply to all stages
12	RFout	RF output pin. The DC is internally blocked at this pin.
Backside Paddle	RF/DC GND	RF/DC ground. See PCB Mounting Pattern for suggested footprint.

### Evaluation Board PCB Information

#### Qorvo PCB 1126637 Material and Stack-up

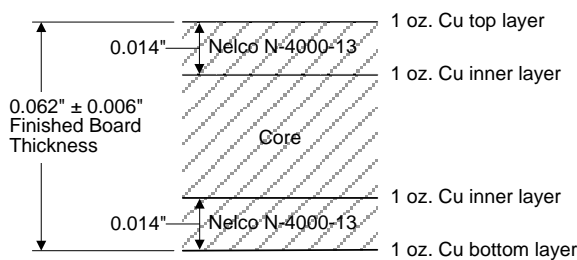

50 ohm line dimensions: width = .028"  
spacing = .028".

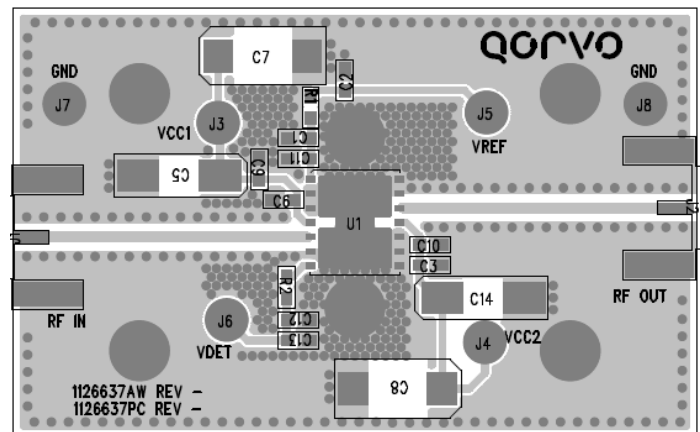

### Package Marking and Dimensions

Marking: Part Number – TQP9424  
Trace Code – XXXX

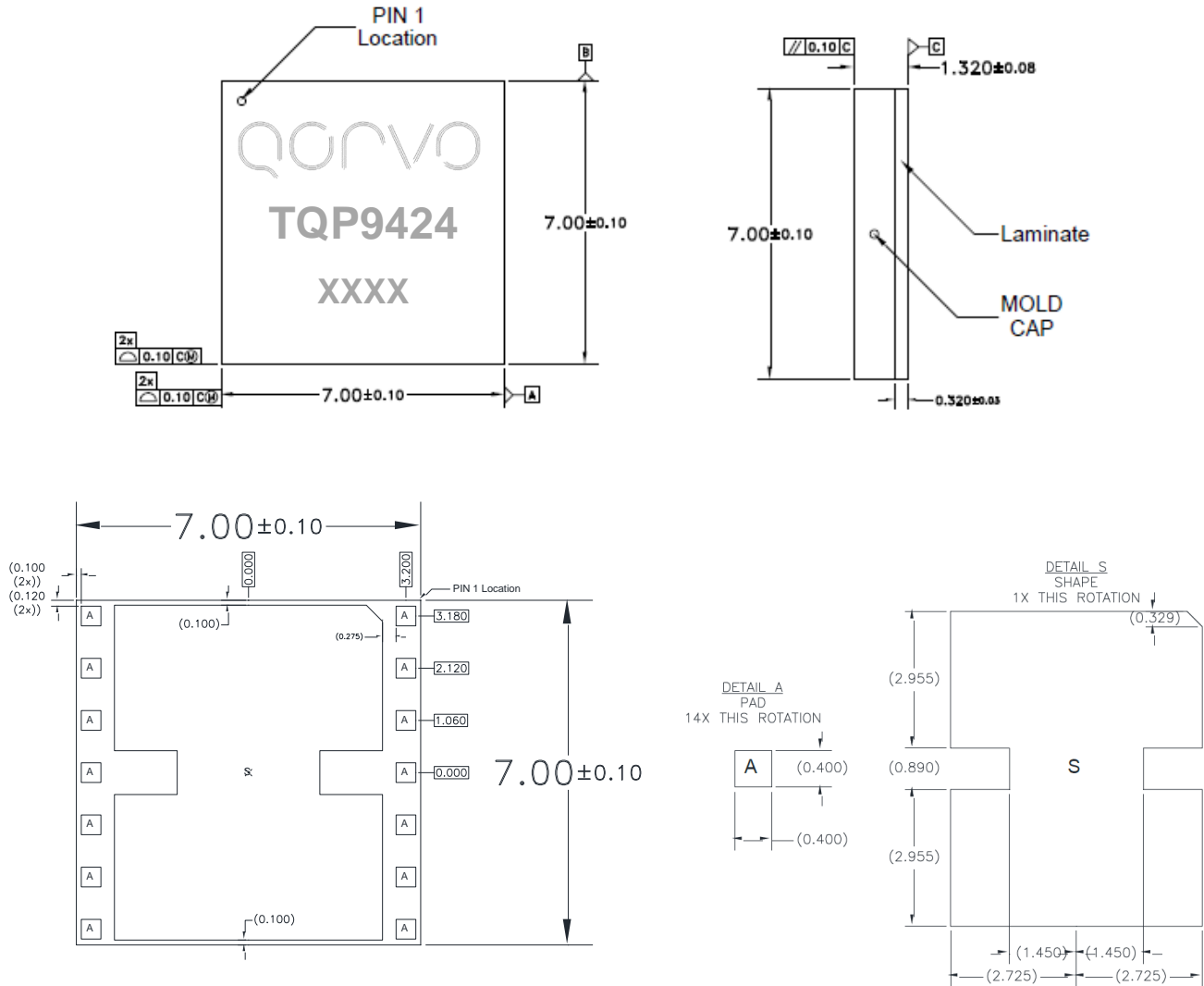

- Notes:
1. All dimensions are in millimeters. Angles are in degrees.
  2. The terminal #1 identifier and terminal numbering conform to JESD 95-1 SPP-012.
  3. Contact plating: NiPdAu

### PCB Mounting Pattern

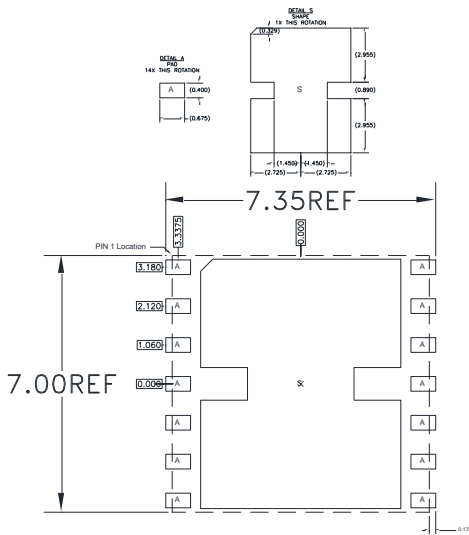

RECOMMENDED  
LAND PATTERN

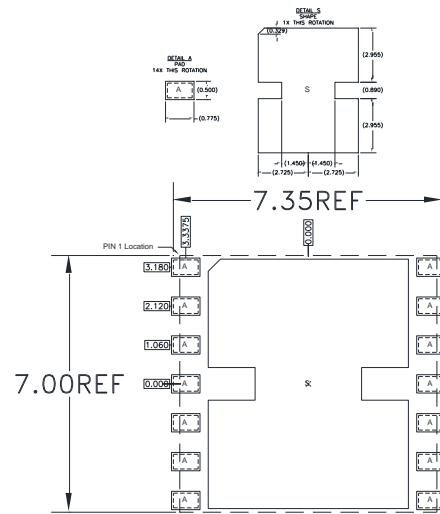

RECOMMENDED  
LAND PATTERN MASK

Notes:

1. All dimensions are in millimeters. Angles are in degrees.
2. Use 1 oz. copper minimum for top and bottom layer metal.
3. Vias are required under the backside paddle of this device for proper RF/DC grounding and thermal dissipation. We recommend a 0.35mm (#80/.0135") diameter bit for drilling via holes and a final plated thru diameter of 0.25 mm (0.10").
4. Ensure good package backside paddle solder attach for reliable operation and best electrical performance.

## Handling Precautions

Parameter	Rating	Standard
ESD – Human Body Model (HBM)	Class 2	ESDA / JEDEC JS-001-2012
ESD – Charged Device Model (CDM)	Class C3	JEDEC JESD22-C101F
MSL – Moisture Sensitivity Level	Level 3	IPC/JEDEC J-STD-020



Caution!  
 ESD-Sensitive Device

## Solderability

Compatible with both lead-free (260°C max. reflow temp.) and tin/lead (245°C max. reflow temp.) soldering processes.

Solder profiles available upon request.

Contact plating: Electrolytic plated Au over Ni

## RoHS Compliance

This part is compliant with the 2011/65/EU RoHS directive (Restrictions on the Use of Certain Hazardous Substances in Electrical and Electronic Equipment) as amended by Directive 2015/863/EU. This product also has the following attributes:

- Product uses RoHS Exemption 7c-I to meet RoHS Compliance requirements.
- Halogen Free (Chlorine, Bromine)
- Antimony Free
- TBBP-A (C<sub>15</sub>H<sub>12</sub>Br<sub>4</sub>O<sub>2</sub>) Free
- PFOS Free
- SVHC Free

## Contact Information

For the latest specifications, additional product information, worldwide sales and distribution locations:

**Tel: 1-844-890-8163**

**Web: [www.qorvo.com](http://www.qorvo.com)**

**Email: [customer.support@qorvo.com](mailto:customer.support@qorvo.com)**

For technical questions and application information: **Email: [appsupport@qorvo.com](mailto:appsupport@qorvo.com)**

## Important Notice

The information contained herein is believed to be reliable; however, Qorvo makes no warranties regarding the information contained herein and assumes no responsibility or liability whatsoever for the use of the information contained herein. All information contained herein is subject to change without notice. Customers should obtain and verify the latest relevant information before placing orders for Qorvo products. The information contained herein or any use of such information does not grant, explicitly or implicitly, to any party any patent rights, licenses, or any other intellectual property rights, whether with regard to such information itself or anything described by such information. **THIS INFORMATION DOES NOT CONSTITUTE A WARRANTY WITH RESPECT TO THE PRODUCTS DESCRIBED HEREIN, AND QORVO HEREBY DISCLAIMS ANY AND ALL WARRANTIES WITH RESPECT TO SUCH PRODUCTS WHETHER EXPRESS OR IMPLIED BY LAW, COURSE OF DEALING, COURSE OF PERFORMANCE, USAGE OF TRADE OR OTHERWISE, INCLUDING THE IMPLIED WARRANTIES OF MERCHANTABILITY AND FITNESS FOR A PARTICULAR PURPOSE.**

Without limiting the generality of the foregoing, Qorvo products are not warranted or authorized for use as critical components in medical, life-saving, or life-sustaining applications, or other applications where a failure would reasonably be expected to cause severe personal injury or death.

Copyright 2016 © Qorvo, Inc. | Qorvo is a registered trademark of Qorvo, Inc.



## X-ON Electronics

Largest Supplier of Electrical and Electronic Components

*Click to view similar products for [RF Amplifier](#) category:*

*Click to view products by [Qorvo](#) manufacturer:*

Other Similar products are found below :

[A82-1](#) [BGA622H6820XTSA1](#) [BGA 728L7 E6327](#) [BGB719N7ESDE6327XTMA1](#) [HMC397-SX](#) [HMC405](#) [HMC561-SX](#) [HMC8120-SX](#)  
[HMC8121-SX](#) [HMC-ALH382-SX](#) [HMC-ALH476-SX](#) [SE2433T-R](#) [SMA3101-TL-E](#) [SMA39](#) [A66-1](#) [A66-3](#) [A67-1](#) [A81-2](#) [LX5535LQ](#)  
[LX5540LL](#) [MAAM02350](#) [HMC3653LP3BETR](#) [HMC549MS8GETR](#) [HMC-ALH435-SX](#) [SMA101](#) [SMA32](#) [SMA411](#) [SMA531](#)  
[SST12LP19E-QX6E](#) [WPM0510A](#) [HMC5929LS6TR](#) [HMC5879LS7TR](#) [HMC1087F10](#) [HMC1086](#) [HMC1016](#) [SMA1212](#) [MAX2689EWS+T](#)  
[MAAMSS0041TR](#) [MAAM37000-A1G](#) [LTC6430AIUF-15#PBF](#) [SMA70-2](#) [SMA4011](#) [A231](#) [HMC-AUH232](#) [LX5511LQ](#) [LX5511LQ-TR](#)  
[HMC7441-SX](#) [HMC-ALH310](#) [XD1001-BD-000V](#) [A4011](#)