

Applications

- LTE Band 1 / Band 3 Uplink Diplexer Infrastructure
- Base Station
- General Purpose Wireless

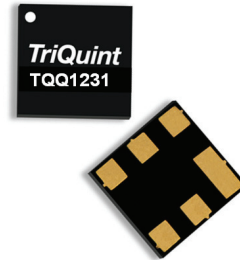

6 Pin 3 x 3 mm leadless SMT Package

Product Features

- 60 MHz Bandwidth – Band 1
- 75 MHz Bandwidth – Band 3
- High Attenuation
- Low Loss
- No External Matching Required
- Single Input, Dual Output Operation
- Small Size: 3.00 x 3.00 x 1.02 mm
- Surface Mount Device
- RoHS Compliant, Pb-Free

Functional Block Diagram

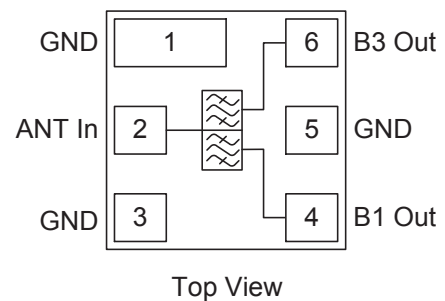

General Description

The TQQ1231 is an exceptionally high performance BAW Diplexer for LTE Band 1 / Band 3 uplink. This filter is housed in a compact 3 x 3 mm package for base station applications.

Low insertion loss, coupled with high attenuation makes this filter an ideal choice for uplink RF filtering needs.

The TQQ1231 is part of TriQuint's extensive portfolio of RF BAW and SAW filters.

Pin Configuration

Pin No.	Label
2	ANT In
4	B1 Out
6	B3 Out
1, 3, 5	GND

Ordering Information

Part No.	Description
TQQ1231	Band 1 / Band 3 BAW Diplexer
TQQ1231-EVB	Evaluation Board

Standard T/R size = 2500 pieces on a 7" reel

Absolute Maximum Ratings

Parameter	Rating
Storage Temperature	-40 to +105°C
RF Input Power	
(CW, +55 °C for 10,000 hours)	+30 dBm
(CW, +95 °C for 2 hours)	+33 dBm
(CW, +95 °C for 1,000 hours)	+30 dBm
(CW, +95 °C for 10 years, MTTF)	+27 dBm

Operation of this device outside the parameter ranges given above may cause permanent damage.
 Operation at +105 °C is possible but with lower MTTF.

Recommended Operating Conditions

Parameter	Min	Typ	Max	Units
T _{CASE}	-40		+105	°C

Electrical specifications are measured at specified test conditions.

Electrical Specifications – Band 3 ^(1,2,3)

Operating Temperature Range: -40 to +95 °C

Parameter	Conditions	Min	Typ ⁽⁴⁾	Max	Units
Passband		1710	-	1785	MHz
Insertion Loss	1710 – 1785 MHz	-	3.1	3.8	dB
Amplitude Ripple ⁽⁵⁾	1710 – 1785 MHz (+25 °C)	-	1.2	1.6	dB
	1710 – 1785 MHz (-40 to +95 °C)	-	1.2	2.2	dB
Group Delay Variation ⁽⁵⁾	1710 – 1785 MHz	-	25	40	ns
	Any 5 MHz window in passband	-	9	20	ns
VSWR	Input	-	2.4:1	2.8:1	-
	Output	-	2.4:1	2.8:1	-
Attenuation ⁽⁶⁾	0.9 – 720 MHz	30	44	-	dB
	720 – 1670 MHz	27	37	-	
	1670 – 1690 MHz (-40 to +25 °C)	12	39	-	
	1670 – 1690 MHz (+25 to +95 °C)	10	39	-	
	1805 – 1825 MHz (-10 to +95 °C)	40	55	-	
	1805 – 1825 MHz (-40 to -10 °C)	35	55	-	
	1825 – 1880 MHz	45	55	-	
	1880 – 1920 MHz	38	45	-	
	1920 – 1980 MHz	38	42	-	
	1980 – 2110 MHz	33	36	-	
	2110 – 2170 MHz	32	39	-	
	2170 – 2660 MHz	20	22	-	
	2660 – 2690 MHz	24	28	-	
2690 – 3600 MHz	10	24	-		
3600 – 5000 MHz	10	25	-		
Input / Output Impedance ⁽⁷⁾		-	50	-	Ohms

Notes:

- All specifications are based on the TriQuint schematic for the main reference design.
- Production test is performed at room temperature to a guard-banded specification to ensure electrical compliance over temperature.
- Electrical margin has been built into the design to account for variation due to temperature drift and manufacturing tolerances.
- Typical values are based on average measurements at room temperature (+25 °C) unless otherwise noted.
- This is defined as the difference between the maximum peak to adjacent valley amplitude change within the specified band.
- Referenced to 0 dB.
- This is the optimum impedance in order to achieve the performance shown.

Electrical Specifications – Band 1 ^(1,2,3)

Operating Temperature Range: -40 to +95 °C

Parameter	Conditions	Min	Typ ⁽⁴⁾	Max	Units
Passband		1920	-	1980	MHz
Insertion Loss	1920 - 1980 MHz	-	3.0	3.8	dB
Amplitude Ripple ⁽⁵⁾	1920 - 1980 MHz (+25 °C)	-	0.7	1.7	dB
	1920 - 1980 MHz (-40 to +95 °C)	-	0.7	2.2	dB
Group Delay Variation ⁽⁵⁾	1920 - 1980 MHz	-	15	40	ns
	Any 5 MHz window in passband	-	7	13	ns
VSWR	Input	-	2.1:1	2.6:1	-
	Output	-	2.1:1	2.6:1	-
Attenuation ⁽⁶⁾	0.9 – 1400 MHz	30	34	-	dB
	1400 – 1495 MHz	30	34	-	
	1495 – 1700 MHz	30	36	-	
	1700 – 1785 MHz	36	40	-	
	1785 – 1870 MHz	30	38	-	
	1870 – 1888 MHz	15	41	-	
	1888 MHz	11	47	-	
	1900 MHz	5	48	-	
	2000 MHz	4	25	-	
	2000 – 2015 MHz	3.5	20	-	
	2012 – 2015 MHz	7.5	36	-	
	2015 – 2030 MHz	8	38	-	
	2030 – 2050 MHz	35	41	-	
	2050 – 2080 MHz	33	39	-	
	2080 – 2170 MHz	30	42	-	
2170 – 4170 MHz	25	32	-		
4170 – 5000 MHz	30	41	-		
5000 – 5720 MHz	10	36	-		
5720 – 6000 MHz	8	40	-		
Input / Output Impedance ⁽⁷⁾		-	50	-	Ohms

Notes:

- All specifications are based on the TriQuint schematic for the main reference design.
- Production test is performed at room temperature to a guard-banded specification to ensure electrical compliance over temperature.
- Electrical margin has been built into the design to account for variation due to temperature drift and manufacturing tolerances.
- Typical values are based on average measurements at room temperature (+25°C) unless otherwise noted.
- This is defined as the difference between the maximum peak to adjacent valley amplitude change within the specified band.
- Referenced to 0dB.
- This is the optimum impedance in order to achieve the performance shown.

Performance Plots

Test conditions unless otherwise noted: Temp= +25°C

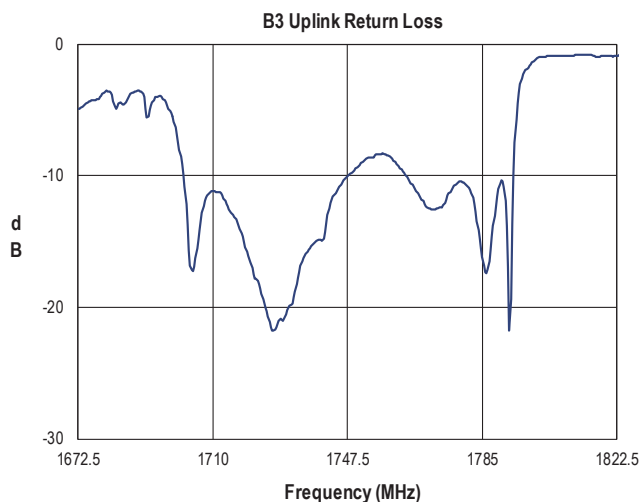
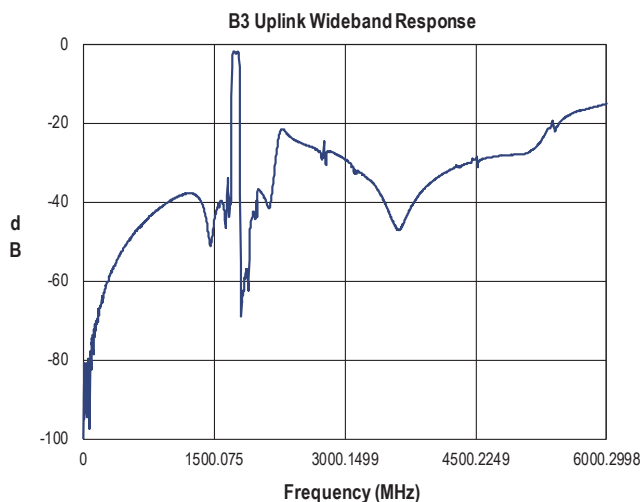
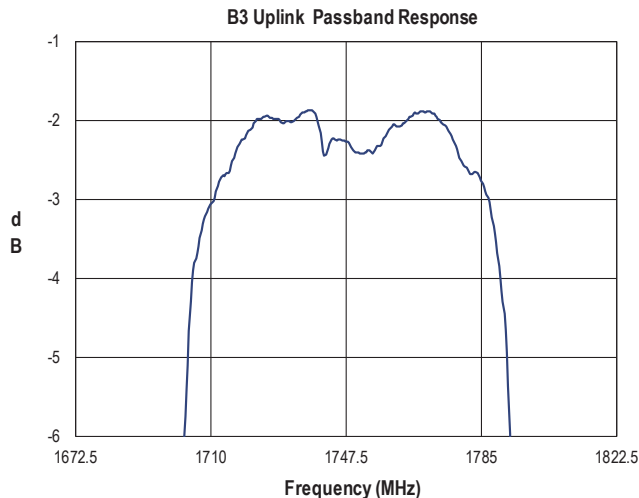
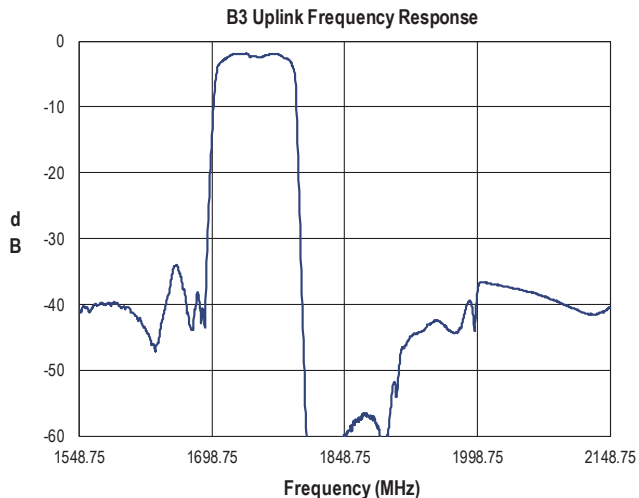

B3 Uplink Path - Ant Port Impedance

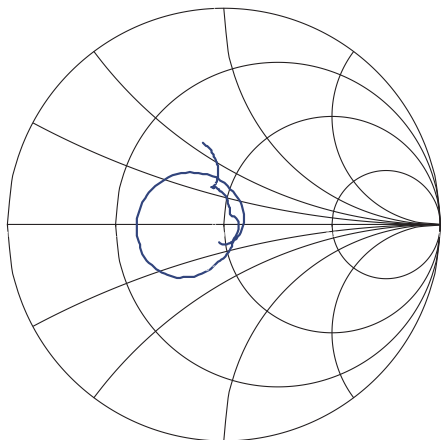

B3 Uplink Port Impedance

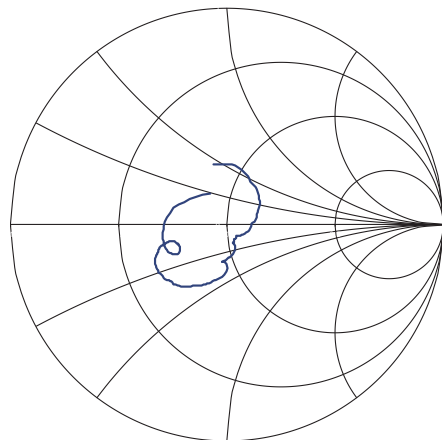

Performance Plots (cont'd.)

Test conditions unless otherwise noted: Temp= +25°C

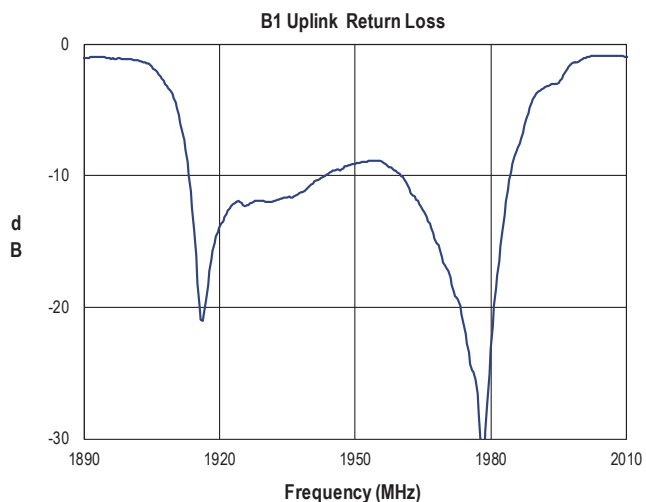
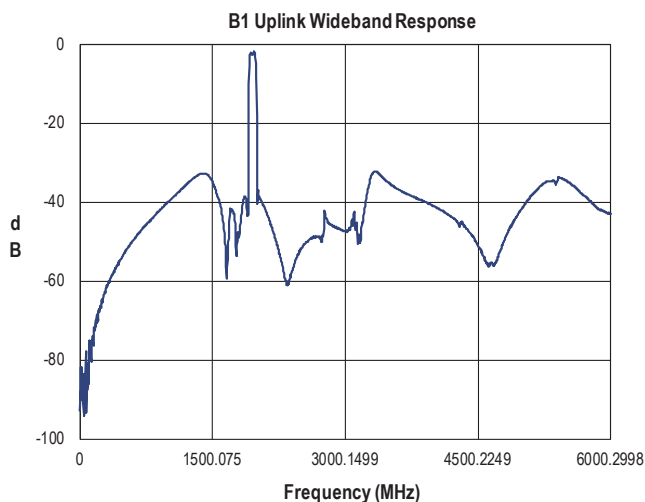
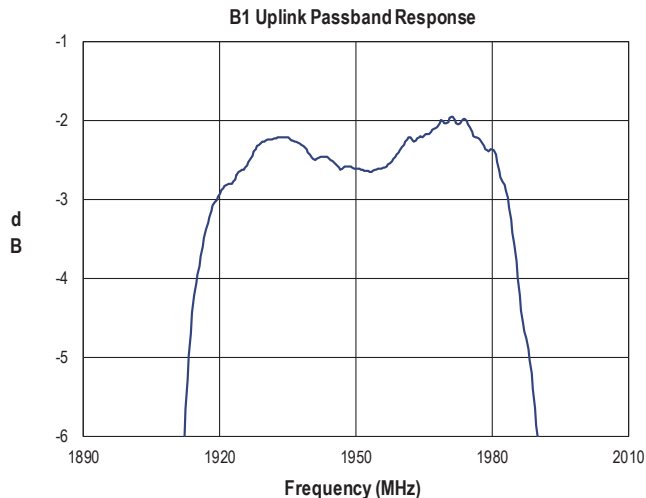
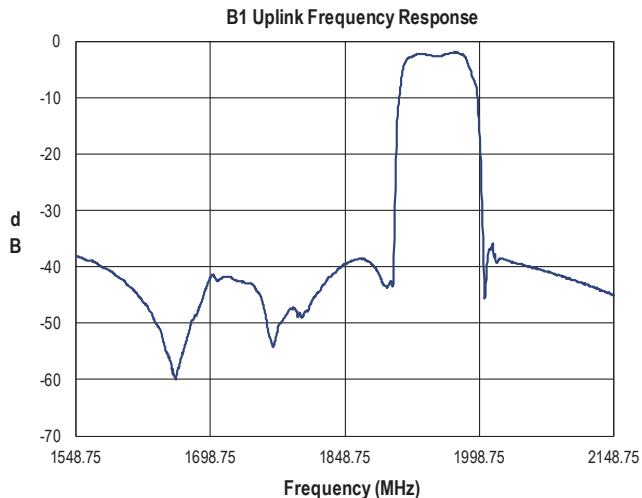

B1 Uplink Path - Ant Port Impedance

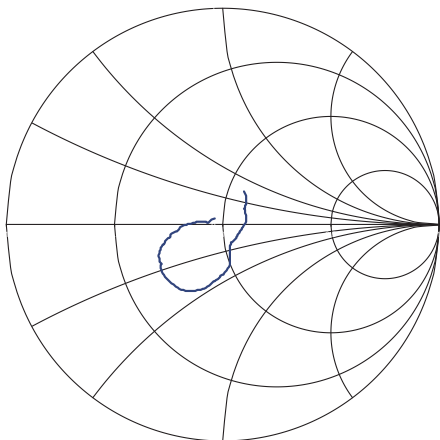

B1 Uplink Port Impedance

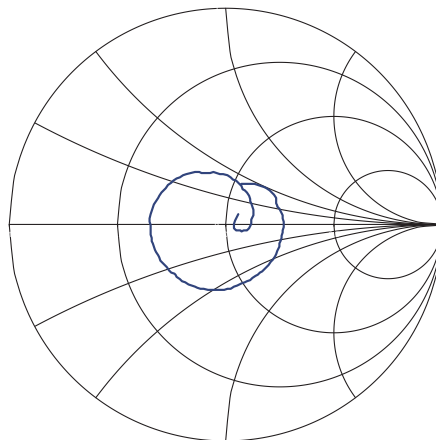

Performance Plots (cont'd.)

Test conditions unless otherwise noted: Temp= +25°C

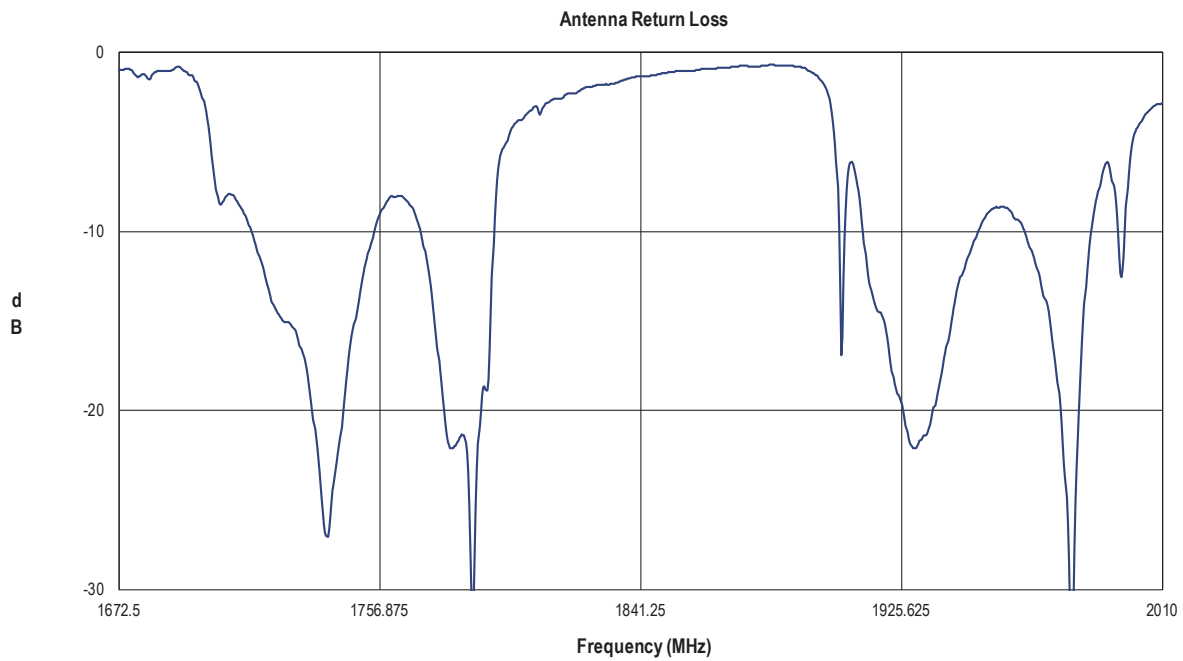
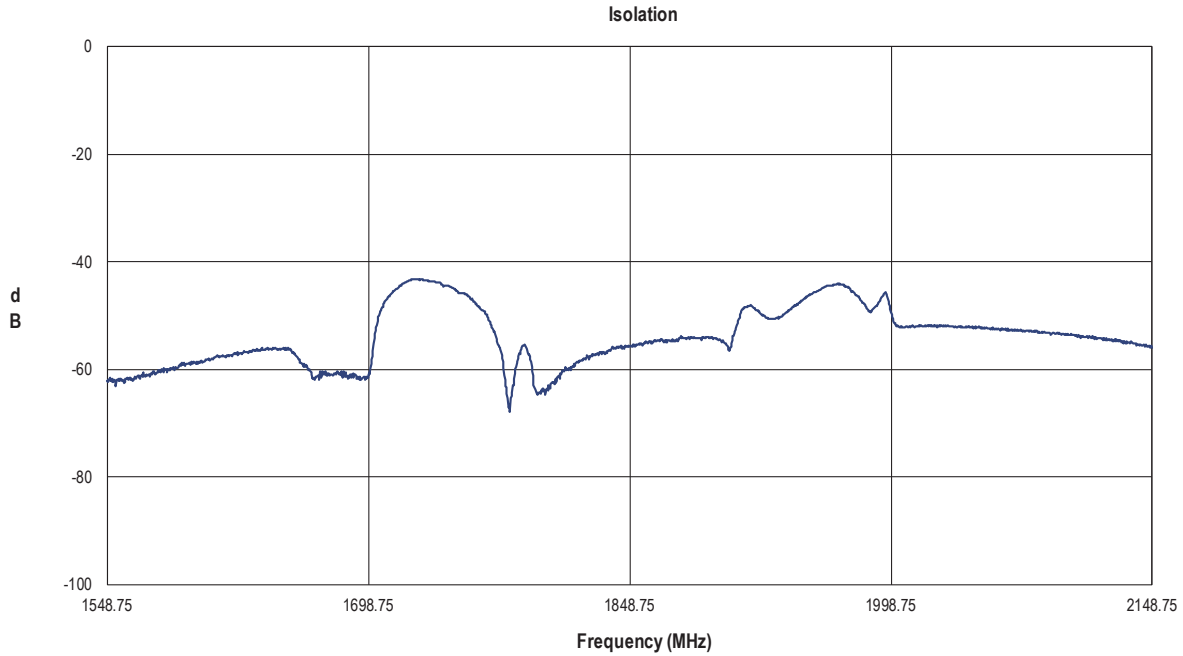

Package Marking and Dimensions

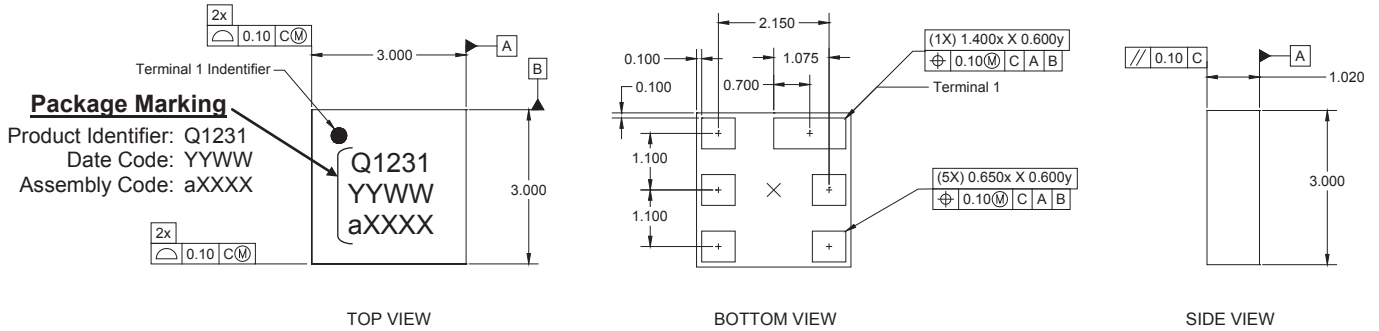

Notes:

1. All dimensions are in millimeters. Angles are in degrees.
2. Except where noted, this part outline conforms to JEDEC standard MO-229.
3. Dimension and tolerance formats conform to ASME Y14.4M-1994.
4. The terminal #1 identifier and terminal numbering conform to JESD 95-1 SPP-012.

PCB Mounting Pattern

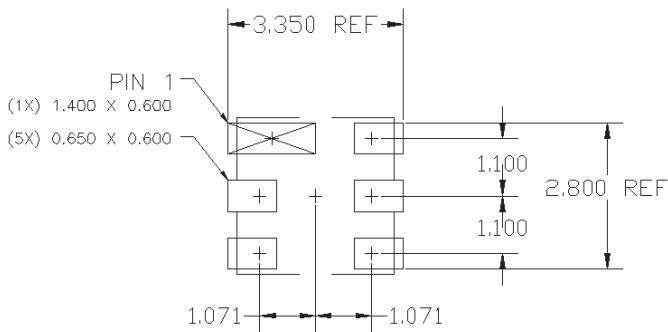

Top view recommended land pattern metallization.

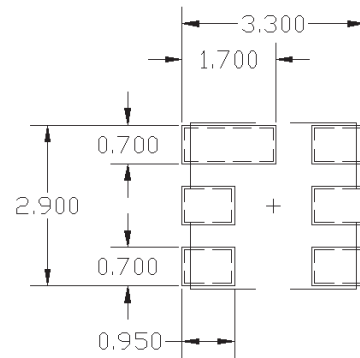

Top view recommended land pattern stencil aperture.

Notes:

1. All dimensions are in millimeters. Angles are in degrees.
2. Use 1 oz. copper minimum for top and bottom layer metal.

Tape and Reel Information – Carrier and Cover Tape Dimensions

Tape and reel specifications for this part are also available on the TriQuint website.
 Standard T/R size = 2500 pieces on a 7” reel.

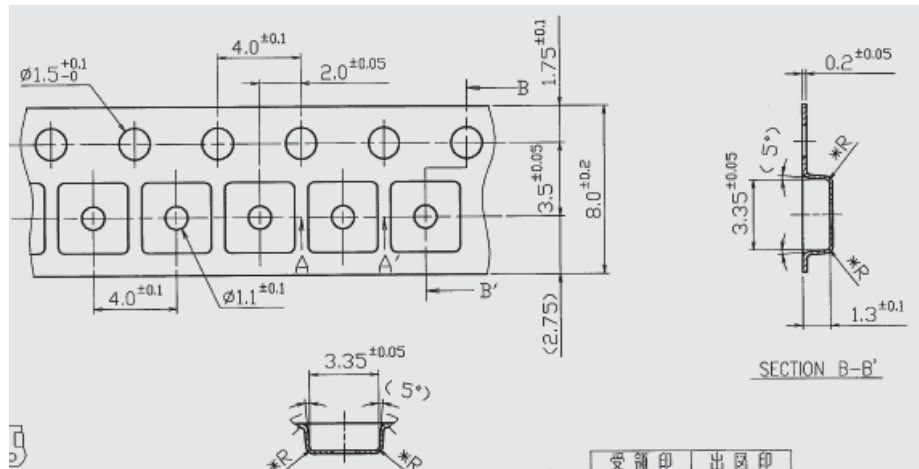

Feature	Measure	Symbol	Size (in)	Size (mm)
Cavity	Length	A0	0.132	3.35
	Width	B0	0.132	3.35
	Depth	K0	0.055	1.40
	Pitch	P1	0.157	4.00
Centerline Distance	Cavity to Perforation - Length Direction	P2	0.079	2.00
	Cavity to Perforation - Width Direction	F	0.138	3.50
Cover Tape	Width	C	0.213	5.40
Carrier Tape	Width	W	0.315	8.00

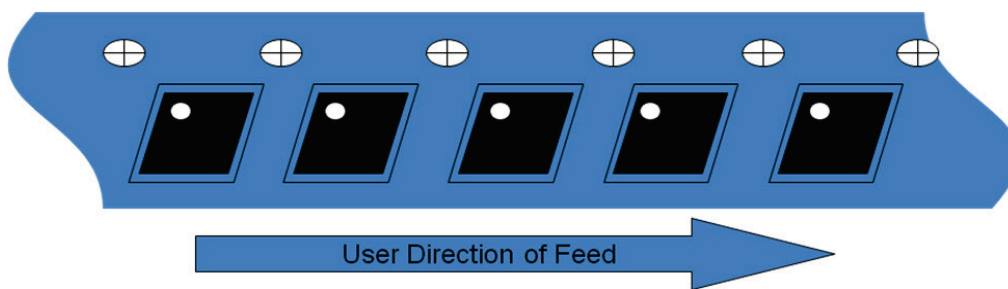

Tape and Reel Information – Reel Dimensions

Tape and reel specifications for this part are also available on the TriQuint website.
 Standard T/R size = 2,500 pieces on a 7" reel.

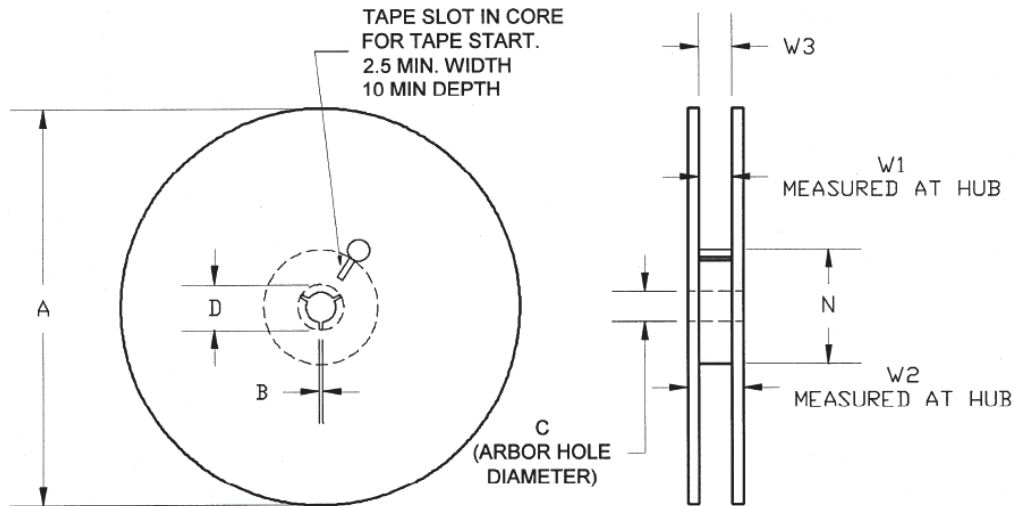

Feature	Measure	Symbol	Size (in)	Size (mm)
Flange	Diameter	A	6.969	177.0
	Thickness	W2	0.559	14.2
	Space Between Flange	W1	0.346	8.8
Hub	Outer Diameter	N	2.283	58.0
	Arbor Hole Diameter	C	0.512	13.0
	Key Slit Width	B	0.079	2.0
	Key Slit Diameter	D	0.787	20.0

Product Compliance Information

ESD Sensitivity Ratings



Caution! ESD-Sensitive Device

ESD Rating: Class 0B
Value: ≥ 125 V to < 250 V
Test: Human Body Model (HBM)
Standard: ESDA / JEDEC Standard JS-001-2012

ESD Rating: Class B
Value: > 200 V to < 400 V
Test: Machine Model (MM)
Standard: JEDEC Standard JESD22-A115

MSL Rating

MSL Rating: Level 3
Test: 260°C convection reflow
Standard: JEDEC Standard IPC/JEDEC J-STD-020

Solderability

Compatible with both lead-free (260°C maximum reflow temperature) and tin/lead (245°C maximum reflow temperature) soldering processes.

Contact plating: ENIG (Electroless Nickel Immersion Gold)

RoHS Compliance

This part is compliant with EU 2002/95/EC RoHS directive (Restrictions on the Use of Certain Hazardous Substances in Electrical and Electronic Equipment).

This product also has the following attributes:

- Lead Free
- Halogen Free (Chlorine, Bromine)
- Antimony Free
- TBBP-A ($C_{15}H_{12}Br_4O_2$) Free
- PFOS Free
- SVHC Free

Contact Information

For the latest specifications, additional product information, worldwide sales and distribution locations, and information about TriQuint:

Web: www.triquint.com **Tel:** +1.503.615.9000
Email: info-sales@triquint.com **Fax:** +1.503.615.8902

For technical questions and application information:

Email: sjapplications.engineering@triquint.com

Important Notice

The information contained herein is believed to be reliable. TriQuint makes no warranties regarding the information contained herein. TriQuint assumes no responsibility or liability whatsoever for any of the information contained herein. TriQuint assumes no responsibility or liability whatsoever for the use of the information contained herein. The information contained herein is provided "AS IS, WHERE IS" and with all faults, and the entire risk associated with such information is entirely with the user. All information contained herein is subject to change without notice. Customers should obtain and verify the latest relevant information before placing orders for TriQuint products. The information contained herein or any use of such information does not grant, explicitly or implicitly, to any party any patent rights, licenses, or any other intellectual property rights, whether with regard to such information itself or anything described by such information.

TriQuint products are not warranted or authorized for use as critical components in medical, life-saving, or life-sustaining applications, or other applications where a failure would reasonably be expected to cause severe personal injury or death.

X-ON Electronics

Largest Supplier of Electrical and Electronic Components

Click to view similar products for [Signal Conditioning](#) category:

Click to view products by [Qorvo](#) manufacturer:

Other Similar products are found below :

[MAPDCC0001](#) [MAPDCC0004](#) [PD0409J5050S2HF](#) [880157](#) [HHS-109-PIN](#) [DC1417J5005AHF](#) [AFS14A30-2185.00-T3](#) [AFS14A35-1591.50-T3](#) [DS-323-PIN](#) [B39321R801H210](#) [1A0220-3](#) [JP510S](#) [LFB212G45SG8C341](#) [LFB322G45SN1A504](#) [LFL182G45TC3B746](#) [SF2159E](#) [30057](#) [FM-104-PIN](#) [CER0813B](#) [MAPDCC0005](#) [3A325](#) [40287](#) [41180](#) [ATB3225-75032NCT](#) [BD0810N50100AHF](#) [BD2425J50200AHF](#) [C5060J5003AHF](#) [JHS-115-PIN](#) [JP503AS](#) [DC0710J5005AHF](#) [DC2327J5005AHF](#) [DC3338J5005AHF](#) [43020](#) [LFB2H2G60BB1C106](#) [LFL15869MTC1B787](#) [X3C19F1-20S](#) [XC3500P-20S](#) [10013-20](#) [SF2194E](#) [CDBLB455KCAX39-B0](#) [TGL2208-SM, EVAL](#) [RF1353C](#) [1E1305-3](#) [1F1304-3S](#) [1G1304-30](#) [B0922J7575AHF](#) [2020-6622-20](#) [10017-3](#) [TP-103-PIN](#) [BD1222J50200AHF](#)