

THESE DRAWINGS ARE THE PROPERTY OF QUALTEK ELECTRONICS AND NOT TO BE REPRODUCED FOR OR COMMUNICATED TO A THIRD PARTY WITHOUT THE EXPRESS WRITTEN PERMISSION OF AN OFFICER OF QUALTEK ELECTRONICS.

REVISION			
REV.	DESCRIPTION	DATE	APPROVED
B	RoHS Compliancy	06-01-06	DP
C	Updated Specifications	09-18-08	LY

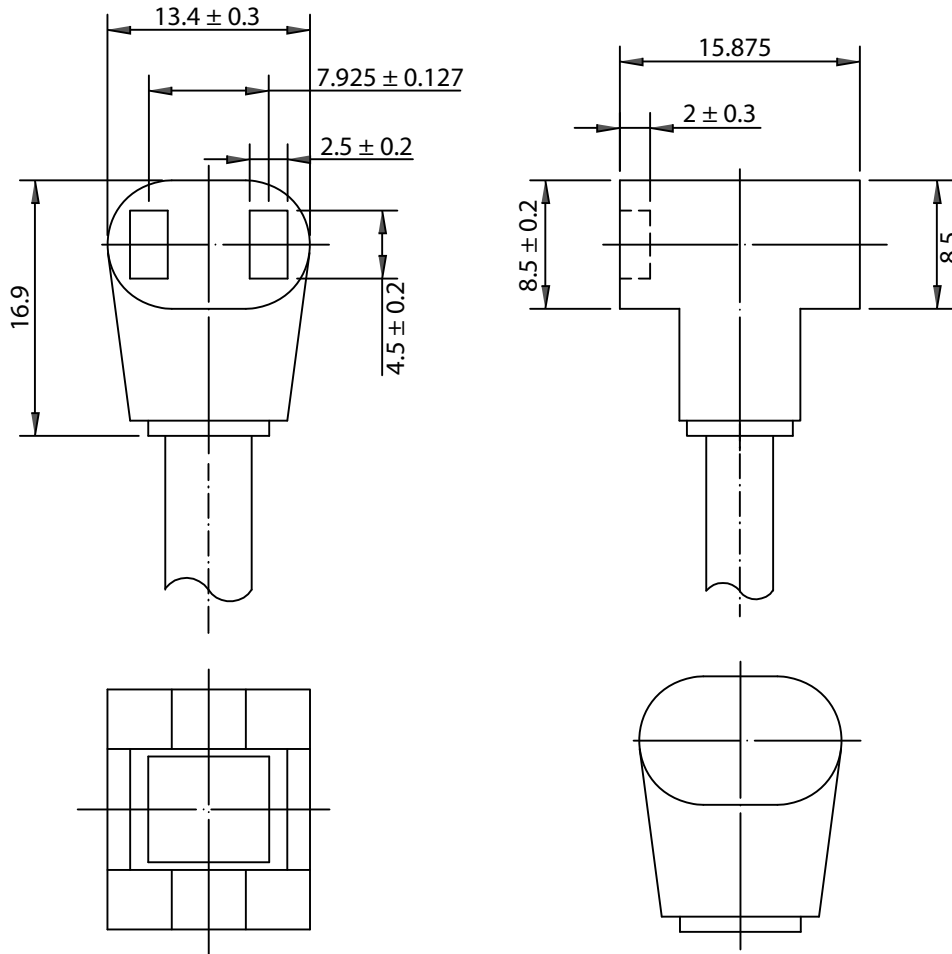

NOTES:

1. RATING: 10A 125VAC
2. CORDAGE: SPT-1, 18/2, 105°C, 300V
3. CORD LENGTH: 1524mm
4. TERMINATION: BLUNT CUT
5. APPROVALS: UL, cUL
6. RoHS COMPLIANT

CONTROLLED

Dim range (mm)	Tolerance +/- (mm)	Qualtek Electronics Corp. FAN-S DIVISION		
		Part Number: 07199-60	RoHS Compliant	
0-1	0.15	Description: MOLDED FAN CORD FEMALE T		
1-6	0.20			
6-18	0.30			
18-50	0.50			
50-120	0.70			
120-250	0.90			
250-500	1.20			
		UNIT: mm	REV: C	
		Drawn / Date	Checked / Date	Approved / Date
		K.Huang 08-21-98	08-21-98	JJH / 08-21-98

X-ON Electronics

Largest Supplier of Electrical and Electronic Components

Click to view similar products for [Fan Accessories](#) category:

Click to view products by [Qualtek](#) manufacturer:

Other Similar products are found below :

[LZ31](#) [LZ32P-1](#) [63070-2-4013](#) [64442-1-7612](#) [71882-2-4053](#) [73816-2-3634](#) [854589-1](#) [95778-1-5171](#) [99485901](#) [1247-4-6254](#) [RF119](#) [2151-4-7320](#) [27453.32262](#) [95779-1-5171](#) [9614-2-4013](#) [99485906](#) [F92-B](#) [2170-4-7320](#) [27453.32241](#) [R88ACPU001M1](#) [R88ACPU001M2](#) [31570-2-4013](#) [LZ215](#) [LZ22-2](#) [LZ24-1](#) [LZ24B](#) [LZ30-9](#) [LZ37-2](#) [450-20-0025](#) [525-00-0009](#) [450-20-0017](#) [450-20-0020](#) [04.846.1353.0](#) [04.846.1453.0](#) [055032](#) [08121](#) [08188](#) [08195](#) [08196](#) [09576-2-4013](#) [54476-2-4013](#) [71883-2-4053](#) [52545-2-4037](#) [63071-2-4013](#) [52544-2-4037](#) [64445-1-7612](#) [66786-4-7320](#) [88601-2-2929](#) [08164](#) [4013-2-4039](#)