



Features:

- Universal AC input/ Full Range
- Energy Efficiency Level VI
- ErP Step 2 Compliant
- NRCAN and GEMS Compliant
- Output Protections: OVP/SCP/OC
- No Load Power Consumption <0.1W
- 1 Year Warranty



Model	QAWA-18-5	QAWA-18-5.9	QAWA-18-7	QAWA-18-7.5	QAWA-18-9	QAWA-18-10	QAWA-18-12	QAWA-18-15	QAWA-18-16	QAWA-18-18	QAWA-18-24
Output Characteristics											
DC Output	5.0V	5.9V	7V	7.5V	9V	10V	12V	15V	16V	18V	24V
Rated Current	3.0A	3.0A	2.5A	2.5A	2.2A	1.9A	1.6A	1.3A	1.2A	1.1A	0.8A
Ripple and Noise	±2% Vo @ Rated Load										
Load Regulation (Typ.)	±5%										
Transient Response (Typ.)	0.5mS for 50% Load Change										
Hold-up Time (Typ.)	10mS @ Rated Load										
Output Protection	Short Circuit, Over Voltage, Over Current										
Ferrite Core	No										
Input Characteristics											
Voltage Range	100VAC~240VAC										
Frequency Range	50Hz-60Hz										
Efficiency	DoE Level VI, Energy Star, ErP Step 2, NRCAN & GEMS Level VI Certified										
AC Current (max)	0.48A										
Input Protection	Internal Primary Current Fuse, Inrush Limiting										
Leakage Current	0.25mA										
Environmental Characteristics											
Operating Temperature	0°C~40°C										
Operating Relative Humidity	20% RH to 80% RH										
Storage Temperature	-20°C~80°C, 10% RH to 90% RH										
Topology	Switching Flyback										
Dielectric Withstand	3000VAC Primary-Secondary										
EMI Conduction & Radiation	Compliance to EN55022 Class B										
Harmonic Current	Compliance to EN61000-3-2, 3										
EMS Immunity	Compliant to IEC61000-4-2, 3, 4, 5, 6, 8, 11										
Characteristics											
MTBF	300,000Hrs (25°C, Telecordia SR-332)										
Dimension (LxWxH)	72x34x69mm (US), 72x34x90mm (EU), 72x50x81mm (UK), 72x40x78 (AU), 72x34x69 (CN)										
Weight	148g (US), 154g (EU), 158g (UK), 150g (AU), 148g (CN)										

Note: Safety Approvals
 EU: CB, CE, LPS
 UK: CB, CE, LPS
 US: CB, UL, cUL, FCC, PSE, BSMI, LPS
 AU: CB, RCM, LPS
 CN: CB, CCC, LPS

PART NUMBER SYSTEM

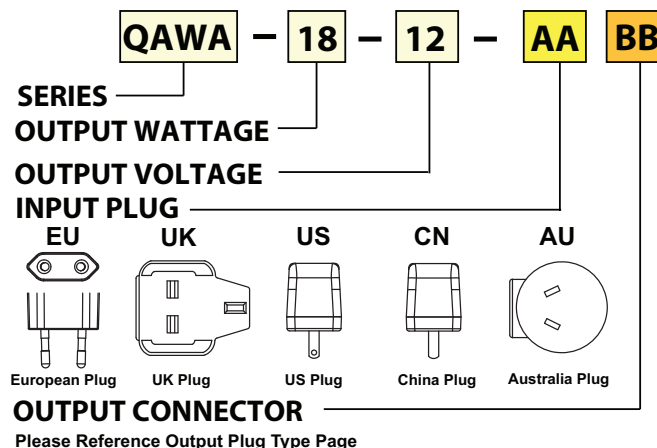

MECHANICAL SPECIFICATIONS

QAWA-18-XX-EU

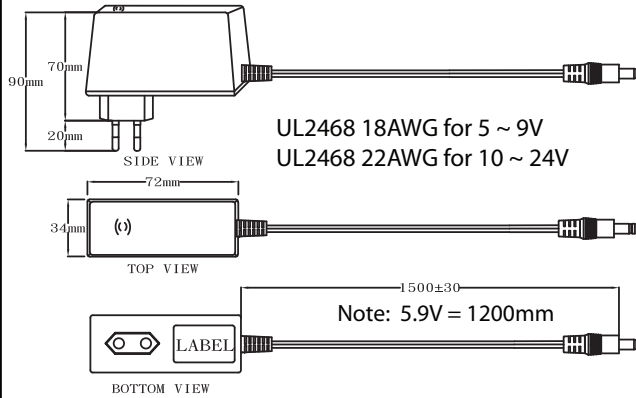

QAWA-18-XX-UK

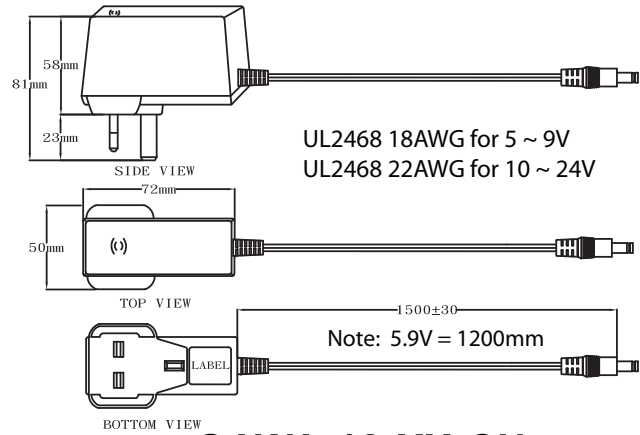

QAWA-18-XX-US

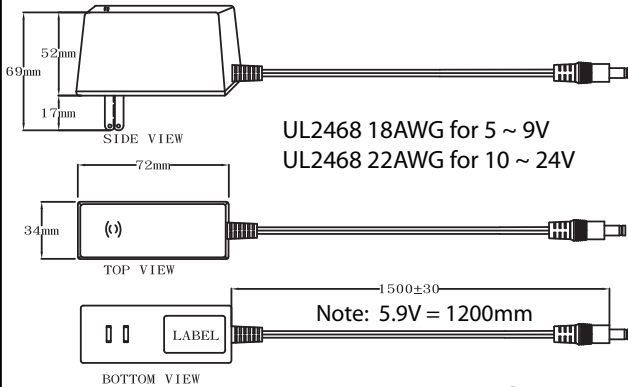

QAWA-18-XX-CN

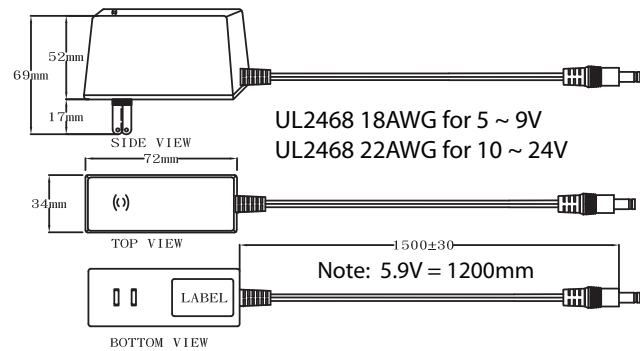

QAWA-18-XX-AU

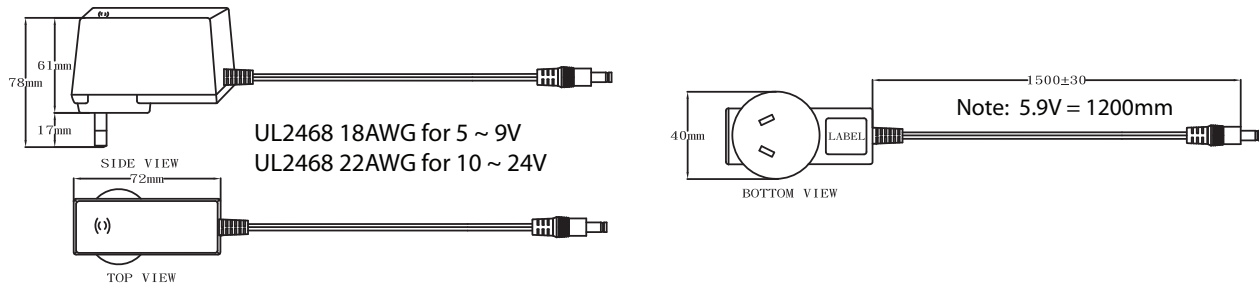

DERATING CURVE

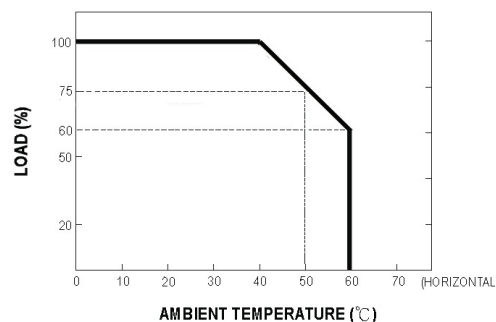

UNIT: mm

X-ON Electronics

Largest Supplier of Electrical and Electronic Components

Click to view similar products for [Wall Mount AC Adapters](#) category:

Click to view products by [Qualtek](#) manufacturer:

Other Similar products are found below :

[ADP-163 E](#) [ADP-167 J](#) [ADP-168 K](#) [ADP-159 A](#) [ADP-165 G](#) [PSAC05A-050L6](#) [RLMDT361800](#) [DA10-050CH](#) [DA5-050US-B](#)
[RLMDT701800](#) [WSU120-2000-R13](#) [WSU180-1330-13](#) [AC-DC ADAPTER 160W](#) [WSU120-2000-13](#) [WSU150-0800-13](#) [WSU075-3200-13](#)
[WSU060-2000-R13](#) [WSU090-2500-13](#) [WSU050-2000-R13](#) [WSU240-1000-13](#) [WSU240-0500-R13](#) [WSU075-1500-13](#) [WSU050-3000-13](#)
[WSU120-1500-13](#) [WSU120-1500-R13](#) [WSU045-1500-13](#) [WSU240-0750-13](#) [WSU090-2500-R13](#) [WSU240-1500-13](#) [WSU180-0660-13](#)
[WSU075-1500-R13](#) [WSU090-1300-13](#) [WSU180-1330-R13](#) [BB-SMI1812VP230C1](#) [WSU050-1500-13](#) [WSU090-0800-13](#) [WSU120-0700-13](#)
[WSU045-3000-13](#) [WSU180-0450-13](#) [WSU150-0560-R13](#) [WSU135-0880-13](#) [WSU120-3000-13](#) [WSU120-1000-R13](#) [WSU090-1300-R13](#)
[WSU060-1250-R13](#) [WSU060-1250-13](#) [WSU045-2000-R13](#) [WSU045-1500-R13](#) [PSAC05A-050L6M](#) [392007-01](#)