



Features:

- Universal AC input/ Full Range
- Energy Efficiency Level VI
- System Control through CC1
- Folding Power Plug
- USB Type C Output Connector
- Output Protections: SCP/OCP/OVP
- No Load Power Consumption <0.1W
- 1 Year Warranty



Model	QFWC-45-20
Output Characteristics	
DC Output	5V / 9V / 12V / 15V / 20V
Rated Current	3A@5V / 3A@9V / 3A@12V / 3A@15V / 2.25A@20V
Ripple and Noise	200mV Max
Load Regulation (Typ.)	±5%
Hold-up Time (Typ.)	10mS @ Rated Load (115V), 20mS @ Rated Load (230V)
Output Protection	Short Circuit, Over Voltage, Over Current
Ferrite Core	No
Input Characteristics	
Voltage Range	100VAC~240VAC
Frequency Range	50Hz-60Hz
Efficiency	DoE Level VI
AC Current (max)	1.0A
Input Protection	Internal Primary Current Fuse
Leakage Current	0.25mA @264VAC/50Hz
Environmental Characteristics	
Operating Temperature	0°C~40°C
Operating Relative Humidity	10% RH to 90% RH
Storage Temperature	-20°C~80°C, 5% RH to 95% RH
Dielectric Withstand	3000VAC/10mA Primary-Secondary
EMI Conduction & Radiation	Compliance to EN55032 Class B, FCC Part 15
Harmonic Current	Compliance to EN61000-3-2, 3
EMS Immunity	Compliance to IEC61000-4-2, 3, 4, 5, 6, 8, 11
Characteristics	
MTBF	More than 50,000Hrs (25°C, Telecordia SR-332)
Dimension (LxWxH)	58x58x29mm

PART NUMBER SYSTEM

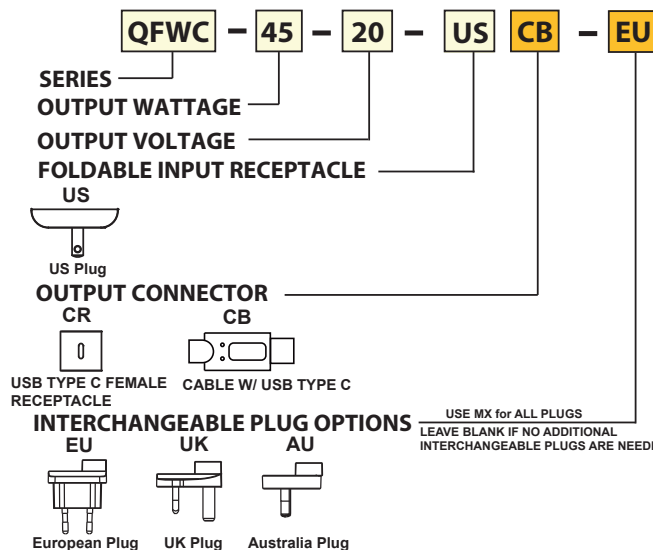

MECHANICAL SPECIFICATIONS

QFWC-45-20-USCB

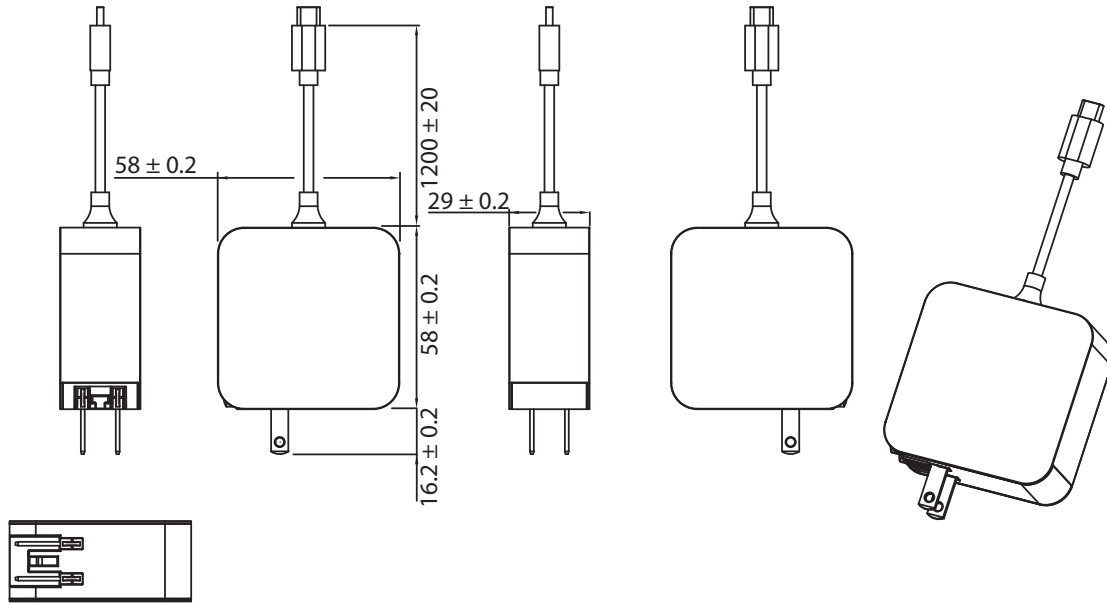

QFWC-45-20-USCR

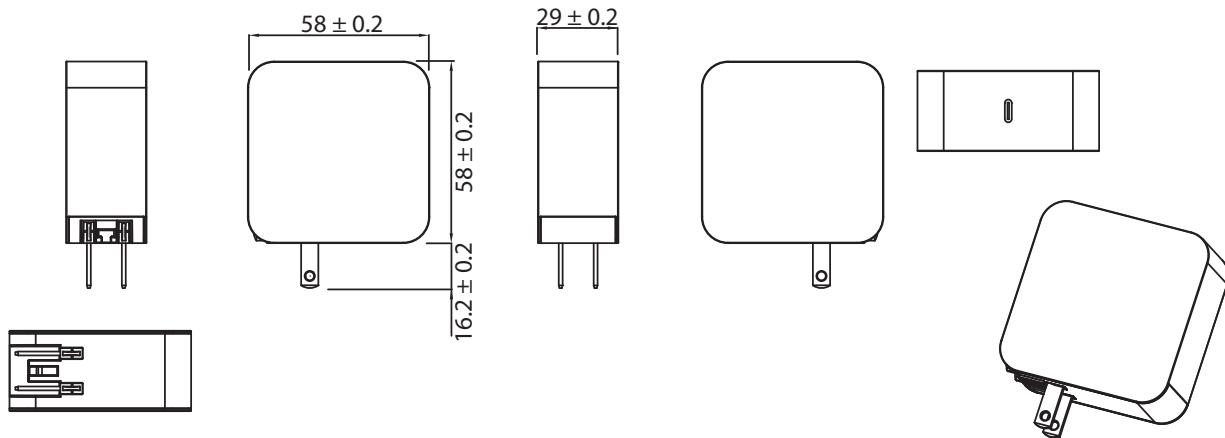

DERATING CURVE

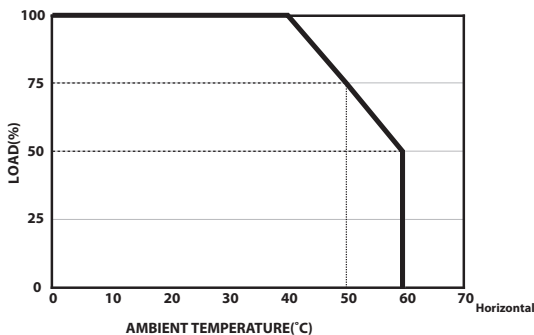

INTERCHANGEABLE PLUGS

(when sold separately)

Australia Plug

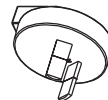

Part Number:
QFWC-AU

European Plug

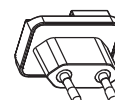

Part Number:
QFWC-EU

UK Plug

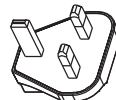

Part Number:
QFWC-UK

UNIT: mm

X-ON Electronics

Largest Supplier of Electrical and Electronic Components

Click to view similar products for [Wall Mount AC Adapters](#) category:

Click to view products by [Qualtek](#) manufacturer:

Other Similar products are found below :

[ADP-163 E](#) [ADP-167 J](#) [ADP-168 K](#) [ADP-159 A](#) [ADP-165 G](#) [PSAC05A-050L6](#) [RLMDT361800](#) [P25A14E-R1C](#) [DA10-050CH](#) [DA5-050US-B](#) [DA10-050UK](#) [RLMDT701800](#) [WSU120-2000-R13](#) [WSU180-1330-13](#) [AC-DC ADAPTER 160W](#) [WSU120-2000-13](#) [WSU150-0800-13](#) [WSU075-3200-13](#) [WSU060-2000-R13](#) [WSU090-2500-13](#) [WSU050-2000-R13](#) [WSU240-1000-13](#) [WSU240-0500-R13](#) [WSU075-1500-13](#) [WSU050-3000-13](#) [WSU120-1500-13](#) [WSU120-1500-R13](#) [WSU045-1500-13](#) [WSU240-0750-13](#) [WSU090-2500-R13](#) [WSU240-1500-13](#) [WSU180-0660-13](#) [WSU075-1500-R13](#) [WSU090-1300-13](#) [WSU180-1330-R13](#) [BB-SMI1812VP230C1](#) [WSU050-1500-13](#) [WSU090-0800-13](#) [WSU120-0700-13](#) [WSU045-3000-13](#) [WSU180-0450-13](#) [WSU150-0560-R13](#) [WSU135-0880-13](#) [WSU120-3000-13](#) [WSU120-1000-R13](#) [WSU090-1300-R13](#) [WSU060-4000-13](#) [WSU060-1250-R13](#) [WSU060-1250-13](#) [WSU045-2000-R13](#)