

# AP2716SD

N and P-Channel Enhancement Mosfet

### Feature

- **N-Channel**  
 $V_{DD}=40V, I_D=10A$   
 $R_{DS(on)} < 22m\Omega @ V_{GS}=10V$   
 $R_{DS(on)} < 30m\Omega @ V_{GS}=4.5V$
- **P-Channel**  
 $V_{DD}=-40V, I_D=-10A$   
 $R_{DS(on)} < 44m\Omega @ V_{GS}=-10V$   
 $R_{DS(on)} < 62m\Omega @ V_{GS}=-4.5V$
- Lead free product is acquired
- High power and current handling capability
- Surface mount package

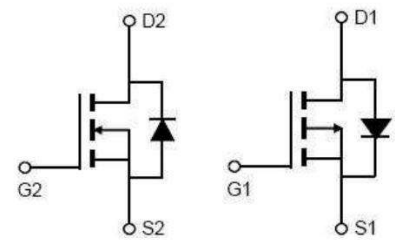

N-channel P-channel

Schematic diagram

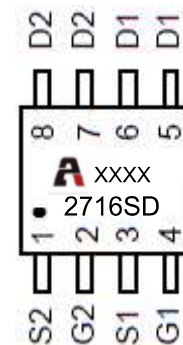

Marking and pin assignment

### Application

- PWM applications
- Load Switch
- Power management

### Package Marking and Ordering Information

Device Marking	Device	Device Package	Reel Size	Tape width	Quantity (PCS)
2716SD	AP2716SD	SOP-8	13 inch	-	4000

### ABSOLUTE MAXIMUM RATINGS ( $T_a=25^\circ\text{C}$ unless otherwise noted)

Parameter	Symbol	N-Channel	P-Channel	Unit
Drain-Source Voltage	$V_{DS}$	40	-40	V
Gate-Source Voltage	$V_{GS}$	$\pm 20$	$\pm 20$	V
Continuous Drain Current ( $T_a = 25^\circ\text{C}$ )	$I_D$	10	-10	A
Continuous Drain Current ( $T_a = 100^\circ\text{C}$ )	$I_D$	6.5	-6.5	A
Pulsed Drain Current <sup>(1)</sup>	$I_{DM}$	40	-40	A
Power Dissipation	$P_D$	4.0	7.5	W
Thermal Resistance from Junction to Ambient	$R_{\theta JA}$	31.3	16.7	$^\circ\text{C}/\text{W}$
Junction Temperature	$T_J$	150	150	$^\circ\text{C}$
Storage Temperature	$T_{STG}$	-55~ +150	-55~ +150	$^\circ\text{C}$

# AP2716SD

N and P-Channel Enhancement Mosfet

# AIIPOWER

DATA SHEET

## N-CH ELECTRICAL CHARACTERISTICS(T<sub>a</sub>=25°C unless otherwise noted)

Parameter	Symbol	Test Condition	Min	Type	Max	Unit
<b>Static Characteristics</b>						
Drain-source breakdown voltage	V <sub>(BR)DSS</sub>	V <sub>GS</sub> = 0V, I <sub>D</sub> = -250μA	40			V
Zero gate voltage drain current	I <sub>DSS</sub>	V <sub>DS</sub> = 100V, V <sub>GS</sub> = 0V			1	μA
Gate-body leakage current	I <sub>GSS</sub>	V <sub>GS</sub> = ±20V, V <sub>DS</sub> = 0V			±100	nA
Gate threshold voltage <sup>(2)</sup>	V <sub>GS(th)</sub>	V <sub>DS</sub> = V <sub>GS</sub> , I <sub>D</sub> = 250μA	1	1.6	2.5	V
Drain-source on-resistance <sup>(2)</sup>	R <sub>DS(on)</sub>	V <sub>GS</sub> = 10V, I <sub>D</sub> = 10A		17	22	mΩ
		V <sub>GS</sub> = 4.5V, I <sub>D</sub> = 6A		22	30	
<b>Dynamic characteristics</b>						
Input Capacitance	C <sub>iss</sub>	V <sub>DS</sub> = 20V, V <sub>GS</sub> = 0V, f = 1MHz		1050		pF
Output Capacitance	C <sub>oss</sub>			84		
Reverse Transfer Capacitance	C <sub>rss</sub>			72		
<b>Switching characteristics</b>						
Turn-on delay time	t <sub>d(on)</sub>	V <sub>DD</sub> = 20V, I <sub>D</sub> = 5A, R <sub>L</sub> = 6Ω V <sub>GS</sub> = 10V, R <sub>G</sub> = 1Ω		11		ns
Turn-on rise time	t <sub>r</sub>			13		
Turn-off delay time	t <sub>d(off)</sub>			36		
Turn-off fall time	t <sub>f</sub>			9		
Total Gate Charge	Q <sub>g</sub>	V <sub>DS</sub> = 20V, I <sub>D</sub> = 5A, V <sub>GS</sub> = 10V		11		nC
Gate-Source Charge	Q <sub>gs</sub>			1.9		
Gate-Drain Charge	Q <sub>gd</sub>			2.2		
<b>Source-Drain Diode characteristics</b>						
Diode Forward voltage <sup>(2)</sup>	V <sub>DS</sub>	V <sub>GS</sub> = 0V, I <sub>S</sub> = 10A			1.2	V
Diode Forward current <sup>(3)</sup>	I <sub>S</sub>		-	-	10	A

**P-CH ELECTRICAL CHARACTERISTICS(T<sub>a</sub>=25°C unless otherwise noted)**

Parameter	Symbol	Test Condition	Min	Type	Max	Unit
<b>Static Characteristics</b>						
Drain-source breakdown voltage	V <sub>(BR)DSS</sub>	V <sub>GS</sub> = 0V, I <sub>D</sub> = -250μA	-40			V
Zero gate voltage drain current	I <sub>DSS</sub>	V <sub>DS</sub> = 100V, V <sub>GS</sub> = 0V			1	μA
Gate-body leakage current	I <sub>GSS</sub>	V <sub>GS</sub> = ±20V, V <sub>DS</sub> = 0V			±100	nA
Gate threshold voltage <sup>(2)</sup>	V <sub>GS(th)</sub>	V <sub>DS</sub> = V <sub>GS</sub> , I <sub>D</sub> = -250μA	-1	-1.7	-2.5	V
Drain-source on-resistance <sup>(2)</sup>	R <sub>DS(on)</sub>	V <sub>GS</sub> = -10V, I <sub>D</sub> = -10A		35	44	mΩ
		V <sub>GS</sub> = -4.5V, I <sub>D</sub> = -6A		48	60	
<b>Dynamic characteristics</b>						
Input Capacitance	C <sub>iss</sub>	V <sub>DS</sub> = -20V, V <sub>GS</sub> = 0V, f = 1MHz		1160		pF
Output Capacitance	C <sub>oss</sub>			155		
Reverse Transfer Capacitance	C <sub>rss</sub>			98		
<b>Switching characteristics</b>						
Turn-on delay time	t <sub>d(on)</sub>	V <sub>DD</sub> = -20V, I <sub>D</sub> = -5A, R <sub>L</sub> = 6Ω V <sub>GS</sub> = -10V, R <sub>G</sub> = 1Ω		8		ns
Turn-on rise time	t <sub>r</sub>			15		
Turn-off delay time	t <sub>d(off)</sub>			23		
Turn-off fall time	t <sub>f</sub>			9		
Total Gate Charge	Q <sub>g</sub>	V <sub>DS</sub> = -20V, I <sub>D</sub> = -5A, V <sub>GS</sub> = -10V		20		nC
Gate-Source Charge	Q <sub>gs</sub>			3.5		
Gate-Drain Charge	Q <sub>gd</sub>			4.2		
<b>Source-Drain Diode characteristics</b>						
Diode Forward voltage <sup>(2)</sup>	V <sub>DS</sub>	V <sub>GS</sub> = 0V, I <sub>S</sub> = -10A			1.2	V
Diode Forward current <sup>(3)</sup>	I <sub>S</sub>		-	-	-10	A

**Notes:**

1. Repetitive Rating: pulse width limited by maximum junction temperature
2. Pulse Test: pulse width ≤ 300μs, duty cycle ≤ 2%
3. Surface Mounted on FR4 Board, t ≤ 10 sec

N-Channel

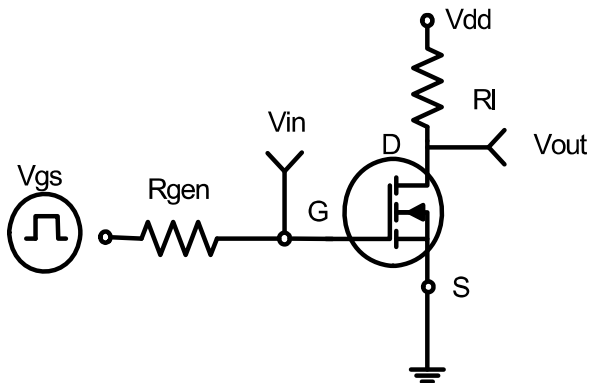

**Figure 1: Switching Test Circuit**

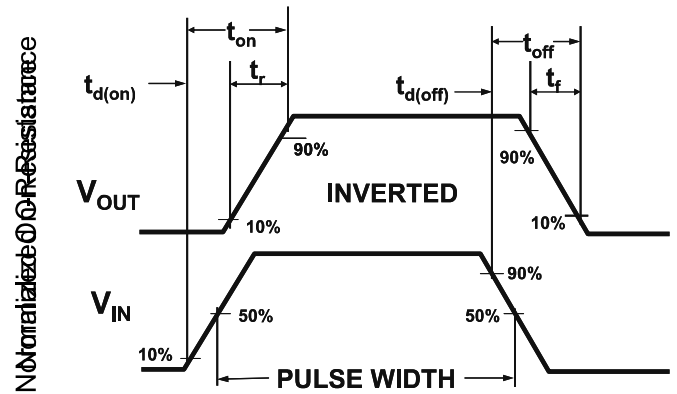

**Figure 2: Switching Waveforms**

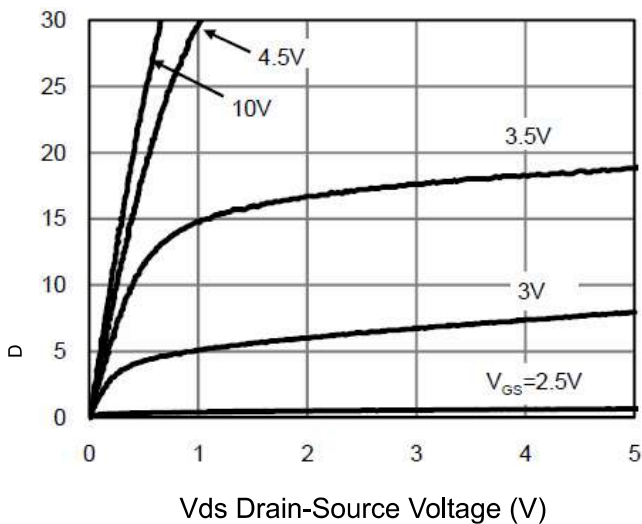

**Figure 3 Output Characteristics**

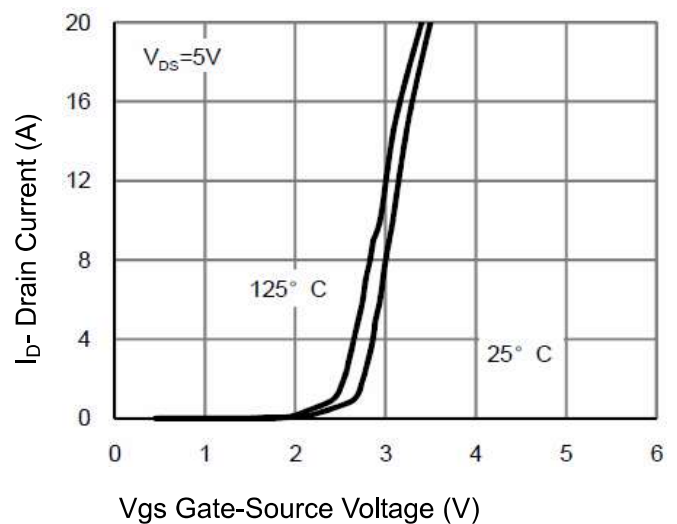

**Figure 4 Transfer Characteristics**

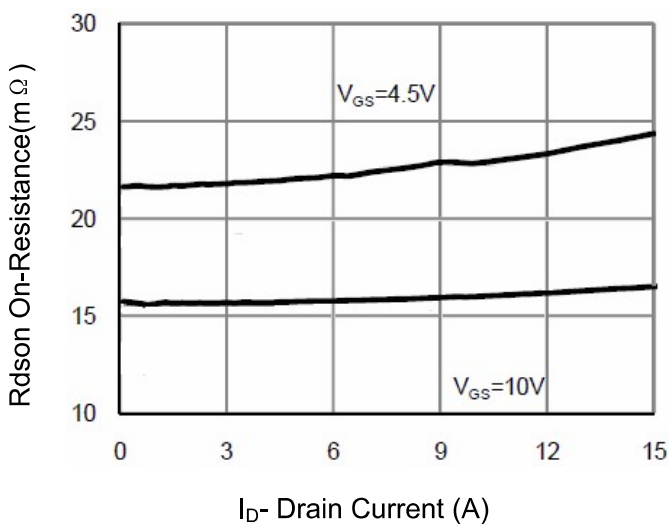

**Figure 5 Drain-Source On-Resistance**

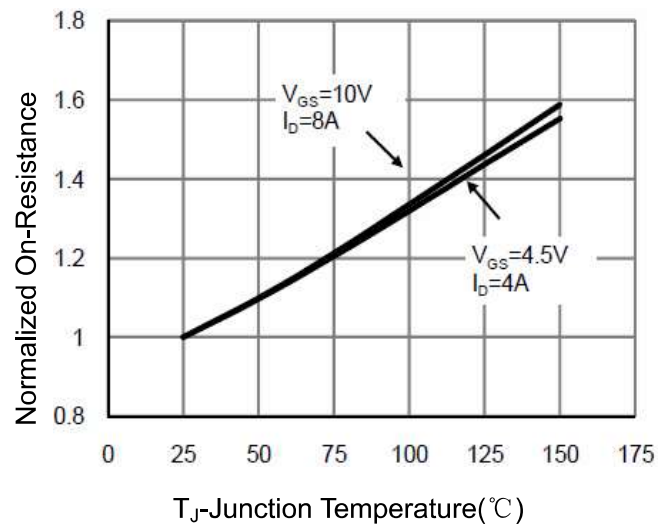

**Figure 6 Drain-Source On-Resistance**

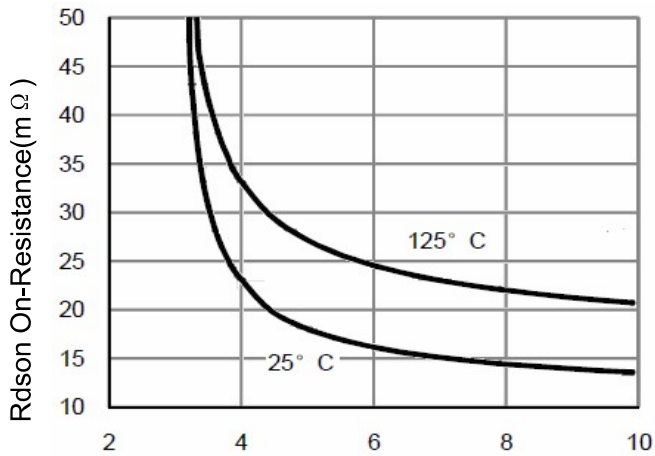

Vgs Gate-Source Voltage (V)  
**Figure 7 Rdson vs Vgs**

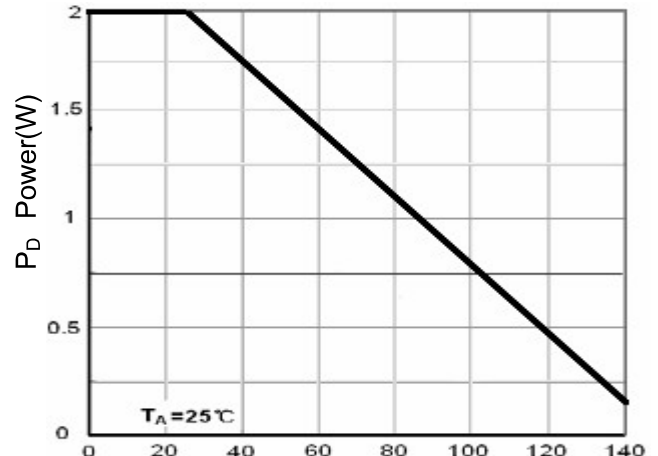

Tj Junction Temperature (°C)  
**Figure 8 Power Dissipation**

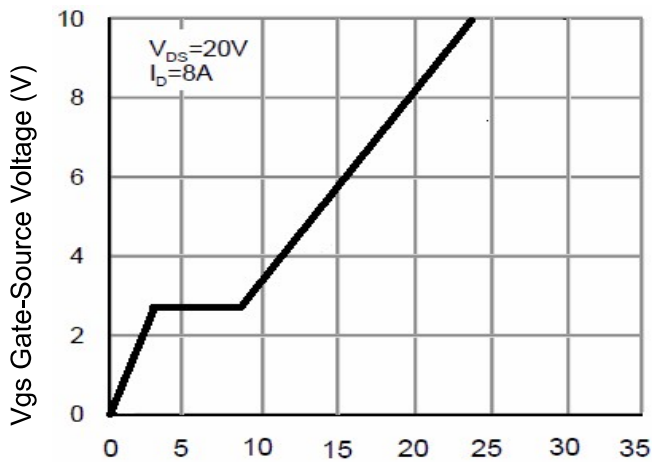

Qg Gate Charge (nC)  
**Figure 9 Gate Charge**

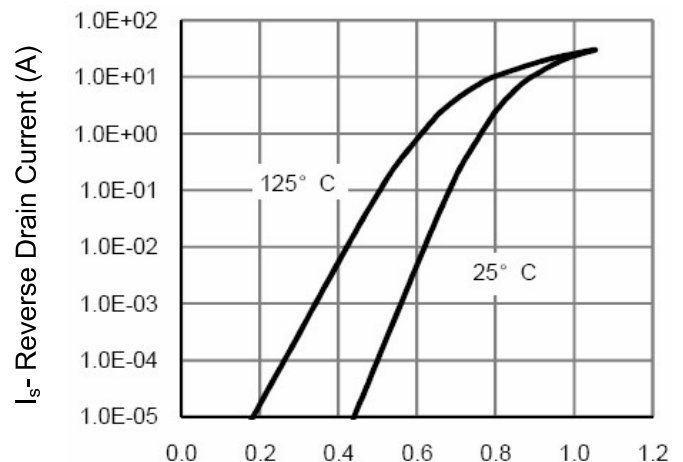

Vds Drain-Source Voltage (V)  
**Figure 10 Source- Drain Diode Forward**

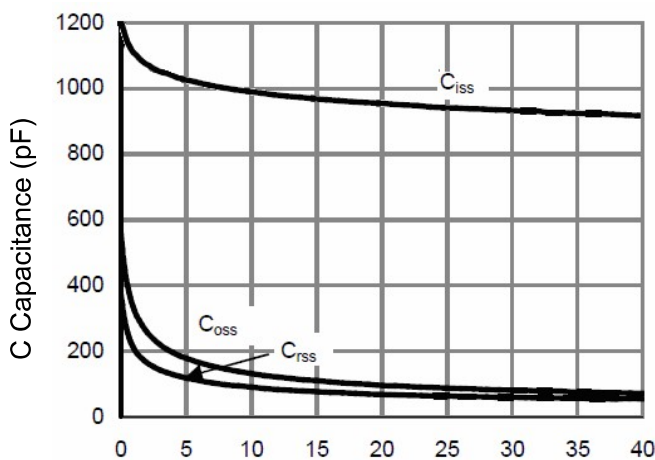

Vds Drain-Source Voltage (V)  
**Figure 11 Capacitance vs Vds**

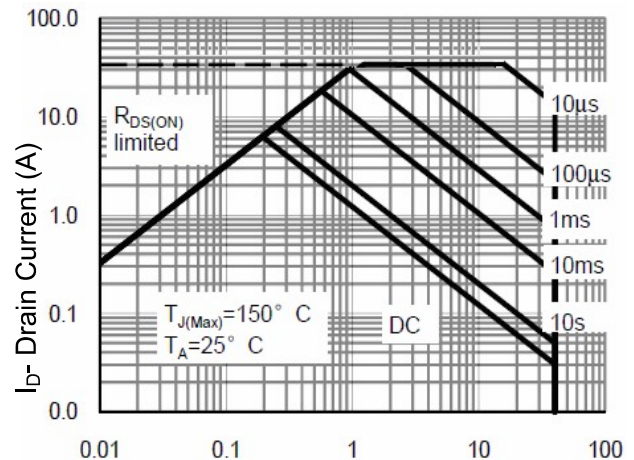

Vds Drain-Source Voltage (V)  
**Figure 12 Safe Operation Area**

P-Channel

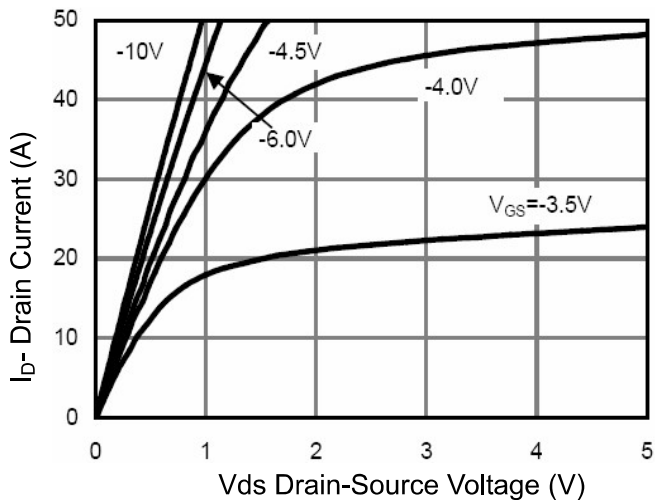

**Figure 1 Output Characteristics**

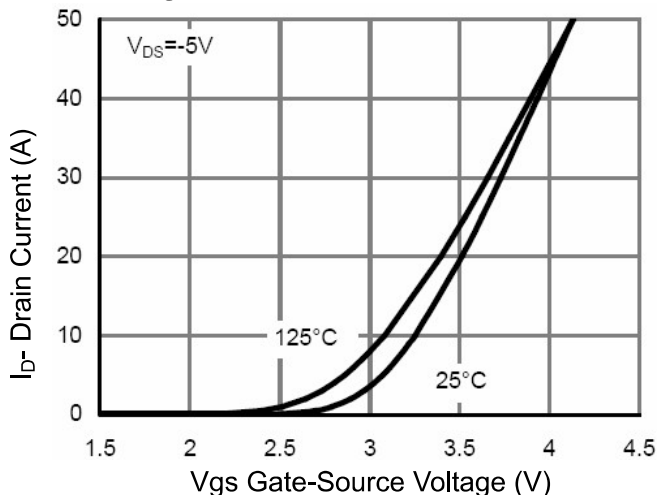

**Figure 2 Transfer Characteristics**

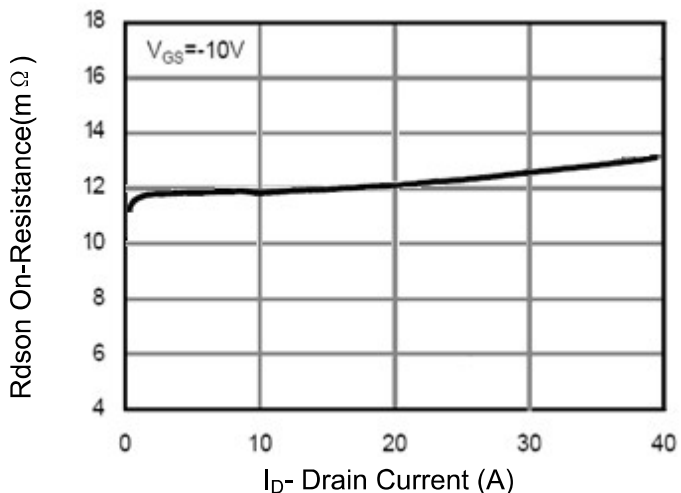

**Figure 3 Rdson- Drain Current**

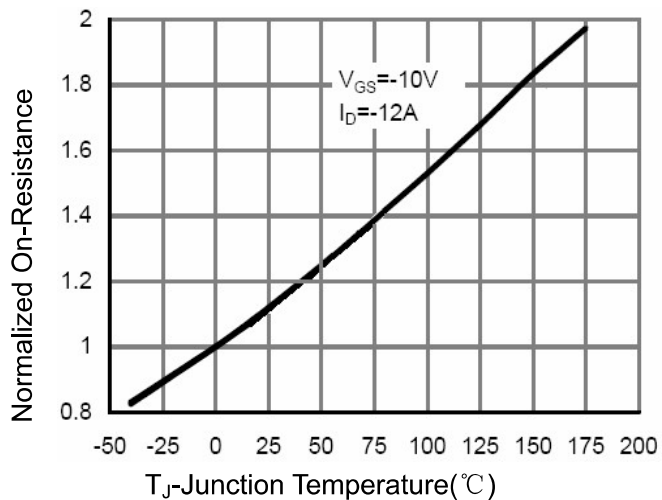

**Figure 4 Rdson-Junction Temperature**

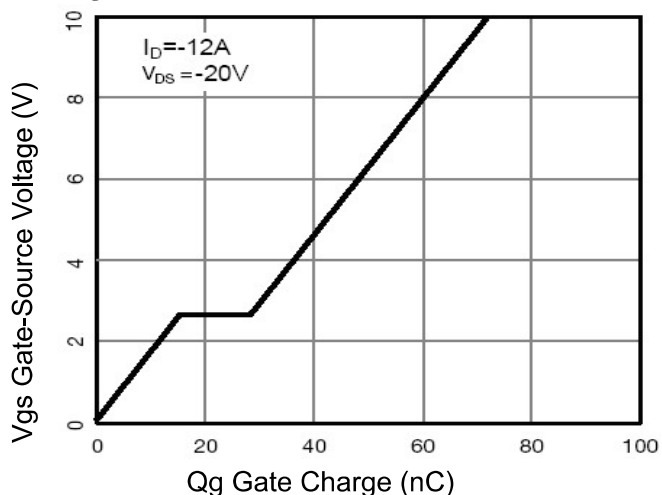

**Figure 5 Gate Charge**

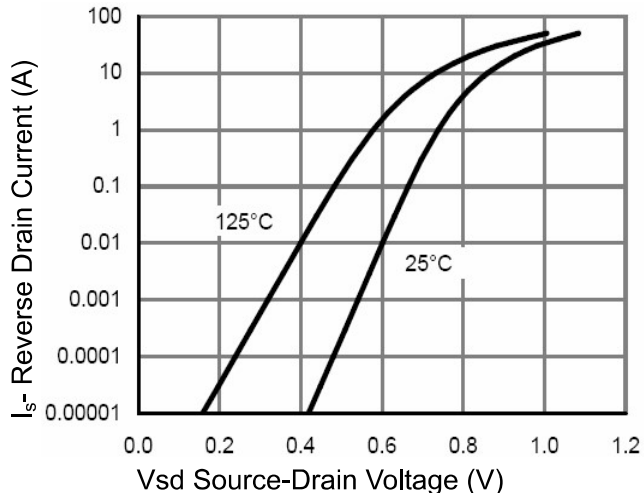

**Figure 6 Source- Drain Diode Forward**

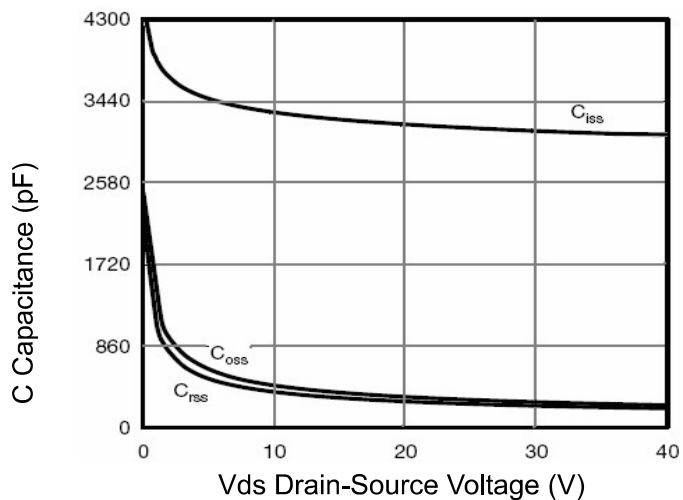

**Figure 7 Capacitance vs Vds**

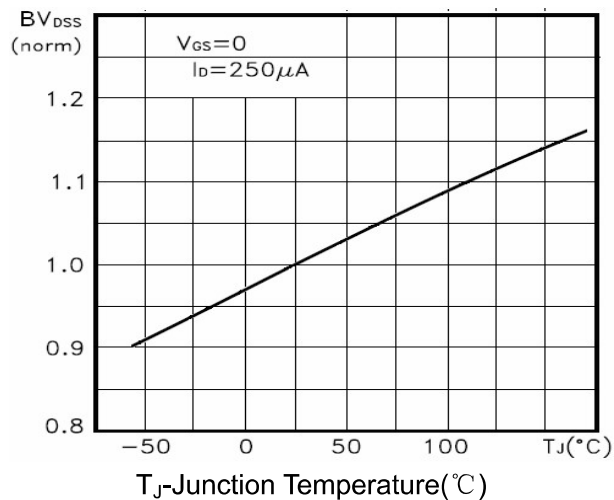

**Figure 9 BV<sub>DSS</sub> vs Junction Temperature**

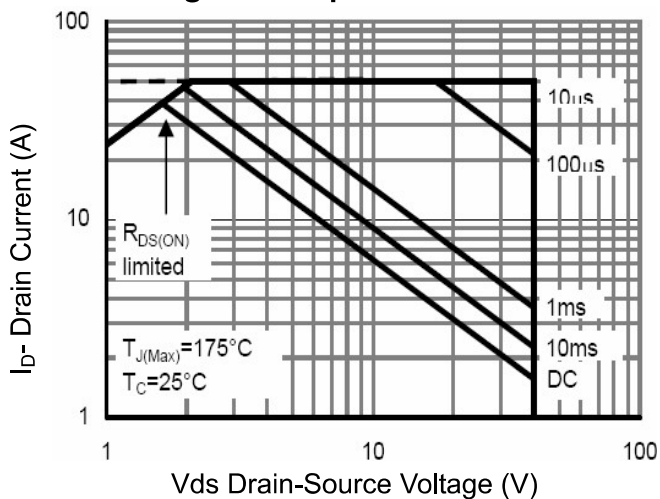

**Figure 8 Safe Operation Area**

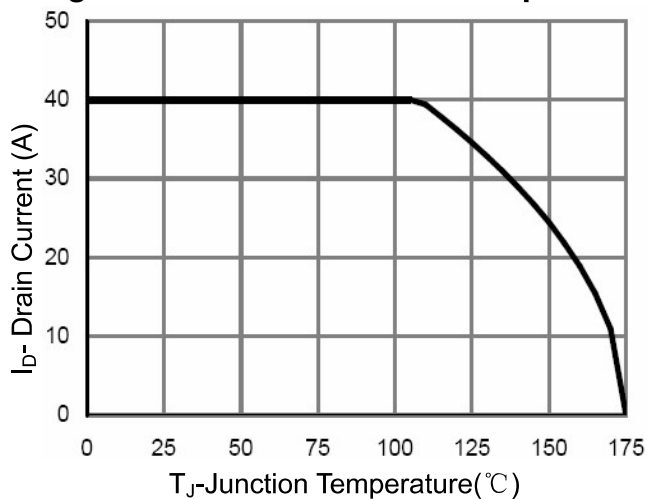

**Figure 10 ID Current Derating vs Junction Temperature**

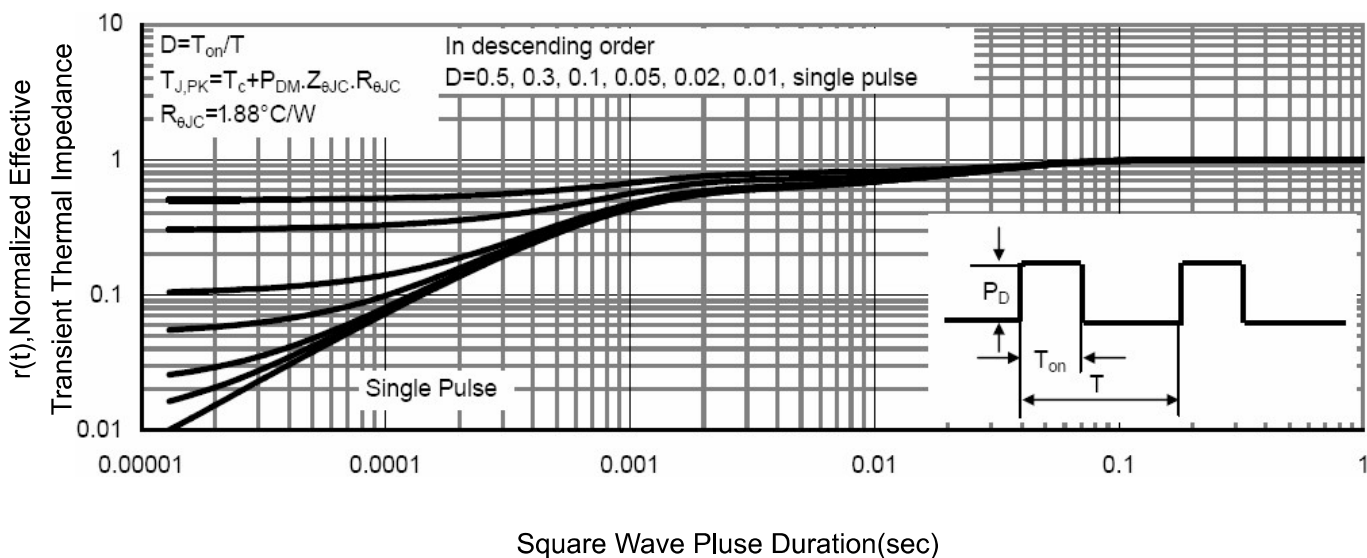
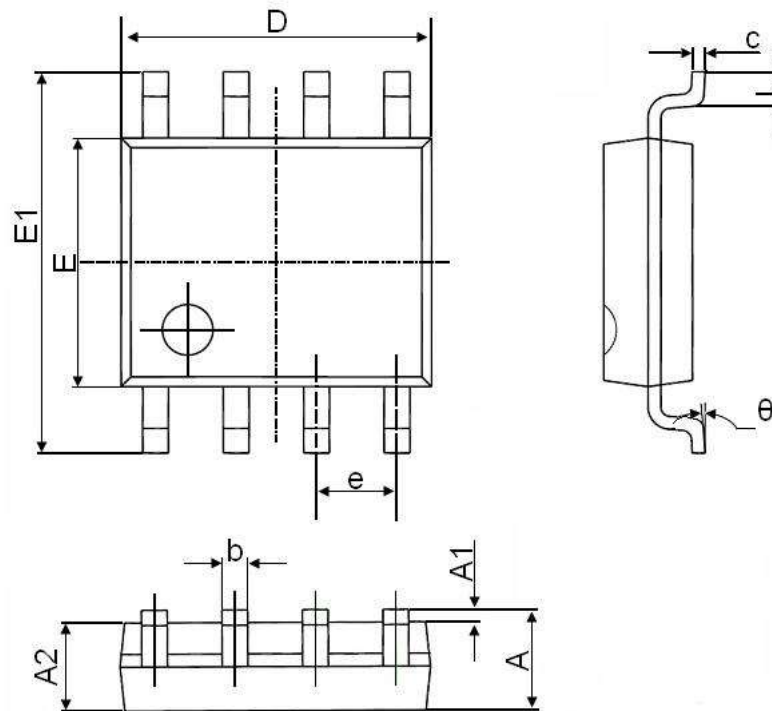

**Figure 11 Normalized Maximum Transient Thermal Impedance**

# AP2716SD

N and P-Channel Enhancement Mosfet

### SOP-8 Package Information



Symbol	Dimensions In Millimeters		Dimensions In Inches	
	Min.	Max.	Min.	Max.
A	1.350	1.750	0.053	0.069
A1	0.100	0.250	0.004	0.010
A2	1.350	1.550	0.053	0.061
b	0.330	0.510	0.013	0.020
c	0.170	0.250	0.006	0.010
D	4.700	5.100	0.185	0.200
E	3.800	4.000	0.150	0.157
E1	5.800	6.200	0.228	0.244
e	1.270(BSC)		0.050(BSC)	
L	0.400	1.270	0.016	0.050
$\theta$	0°	8°	0°	8°



## X-ON Electronics

Largest Supplier of Electrical and Electronic Components

*Click to view similar products for [MOSFET](#) category:*

*Click to view products by [Quan Li](#) manufacturer:*

Other Similar products are found below :

[614233C](#) [648584F](#) [MCH3443-TL-E](#) [MCH6422-TL-E](#) [FDPF9N50NZ](#) [NTNS3A92PZT5G](#) [IRFD120](#) [IRFF430](#) [JANTX2N5237](#) [2N7000](#)  
[AOD464](#) [2SK2267\(Q\)](#) [2SK2545\(Q,T\)](#) [405094E](#) [423220D](#) [MIC4420CM-TR](#) [VN1206L](#) [614234A](#) [715780A](#) [SSM6J414TU,LF\(T](#) [751625C](#)  
[IPS70R2K0CEAKMA1](#) [BSF024N03LT3 G](#) [PSMN4R2-30MLD](#) [TK31J60W5,S1VQ\(O](#) [2SK2614\(TE16L1,Q\)](#) [DMN1017UCP3-7](#)  
[EFC2J004NUZTDG](#) [FCAB21350L1](#) [P85W28HP2F-7071](#) [DMN1053UCP4-7](#) [NTE2384](#) [NTE2969](#) [NTE6400A](#) [DMC2700UDMQ-7](#)  
[DMN2080UCB4-7](#) [DMN61D9UWQ-13](#) [US6M2GTR](#) [DMN31D5UDJ-7](#) [SSM6P54TU,LF](#) [DMP22D4UFO-7B](#) [IPS60R3K4CEAKMA1](#)  
[DMN1006UCA6-7](#) [DMN16M9UCA6-7](#) [STF5N65M6](#) [IRF40H233XTMA1](#) [IPSA70R950CEAKMA1](#) [IPSA70R2K0CEAKMA1](#) [STU5N65M6](#)  
[C3M0021120D](#)