

AP3100A

N-Channel Enhancement Mosfet

AIPOWER

DATA SHEET

Feature

- 30V,8A
 $R_{DS(ON)} < 12m\Omega @ V_{GS}=10V$ TYP:9.8m Ω
 $R_{DS(ON)} < 16m\Omega @ V_{GS}=4.5V$ TYP:13.5 m Ω
- Advanced Trench Technology
- Lead free product is acquired
- Excellent $R_{DS(ON)}$ and Low Gate Charge

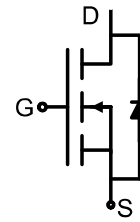

Schematic Diagram

Application

- PWM applications
- Load Switch
- Power management

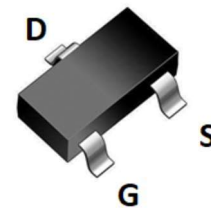

SOT-23-3 top view

Package Marking and Ordering Information

Device Marking	Device	Device Package	Reel Size	Tape width	Quantity (PCS)
3100A	AP3100A	SOT23-3	7 inch	-	3000

ABSOLUTE MAXIMUM RATINGS ($T_a=25^{\circ}C$ unless otherwise noted)

Parameter	Symbol	Value	Unit
Drain-Source Voltage	V_{DS}	30	V
Gate-Source Voltage	V_{GS}	± 20	V
Continuous Drain Current ($T_a=25^{\circ}C$)	I_D	8	A
Continuous Drain Current ($T_a=100^{\circ}C$)	I_D	6.2	A
Pulsed Drain Current ⁽¹⁾	I_{DM}	40	A
Power Dissipation	P_D	1.6	W
Thermal Resistance from Junction to Ambient ⁽³⁾	$R_{\theta JA}$	78	$^{\circ}C/W$
Junction Temperature	T_J	150	$^{\circ}C$
Storage Temperature	T_{STG}	-55~ +150	$^{\circ}C$

MOSFET ELECTRICAL CHARACTERISTICS($T_a=25^{\circ}\text{C}$ unless otherwise noted)

Parameter	Symbol	Test Condition	Min	Type	Max	Unit
Static Characteristics						
Drain-source breakdown voltage	$V_{(BR)DSS}$	$V_{GS} = 0V, I_D = 250\mu A$	30	-	-	V
Zero gate voltage drain current	I_{DSS}	$V_{DS} = 30V, V_{GS} = 0V$	-	-	1	μA
Gate-body leakage current	I_{GSS}	$V_{GS} = \pm 20V, V_{DS} = 0V$	-	-	± 100	nA
Gate threshold voltage ⁽²⁾	$V_{GS(th)}$	$V_{DS} = V_{GS}, I_D = 250\mu A$	1	1.5	2.5	V
Drain-source on-resistance ⁽²⁾	$R_{DS(on)}$	$V_{GS} = 10V, I_D = 8A$	-	9.8	12	m Ω
		$V_{GS} = 4.5V, I_D = 4A$	-	13.5	16	
Dynamic characteristics						
Input Capacitance	C_{iss}	$V_{DS} = 15V, V_{GS} = 0V, f = 1MHz$	-	1140	-	pF
Output Capacitance	C_{oss}		-	175	-	
Reverse Transfer Capacitance	C_{rss}		-	151	-	
Switching characteristics						
Turn-on delay time	$t_{d(on)}$	$V_{DD} = 15V, I_D = 4A,$ $V_{GS} = 10V, R_G = 3\Omega$	-	15	-	ns
Turn-on rise time	t_r		-	19	-	
Turn-off delay time	$t_{d(off)}$		-	35	-	
Turn-off fall time	t_f		-	21	-	
Total Gate Charge	Q_g	$V_{DS} = 15V, I_D = 4A,$ $V_{GS} = 10V$	-	13.3	-	nC
Gate-Source Charge	Q_{gs}		-	3.1	-	
Gate-Drain Charge	Q_{gd}		-	5	-	
Source-Drain Diode characteristics						
Diode Forward voltage ⁽²⁾	V_{DS}	$V_{GS} = 0V, I_S = 8A$	-	-	1.2	V
Diode Forward current ⁽³⁾	I_S		-	-	8	A

Notes:

1. Repetitive Rating: pulse width limited by maximum junction temperature
2. Pulse Test: pulse width $\leq 300\mu s$, duty cycle $\leq 2\%$
3. Surface Mounted on FR4 Board, $t_s \leq 10$ sec

Test Circuit

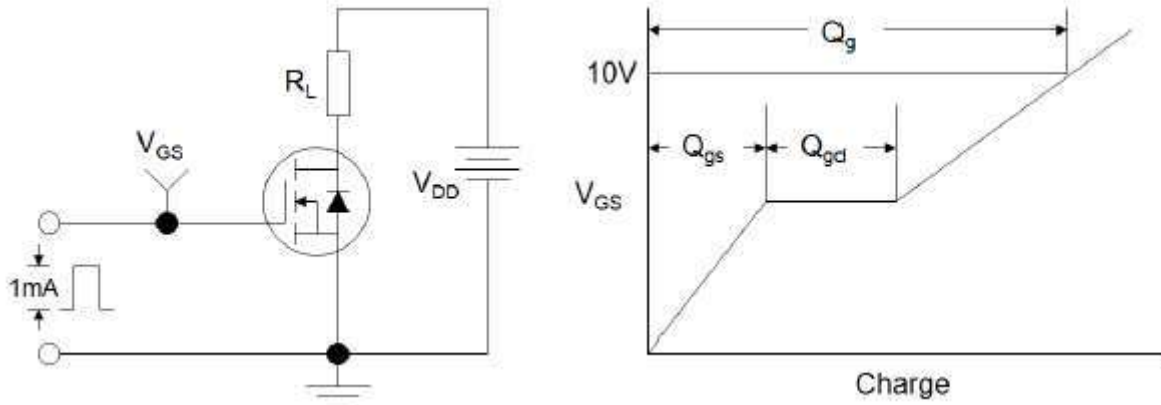

Figure1:Gate Charge Test Circuit & Waveform

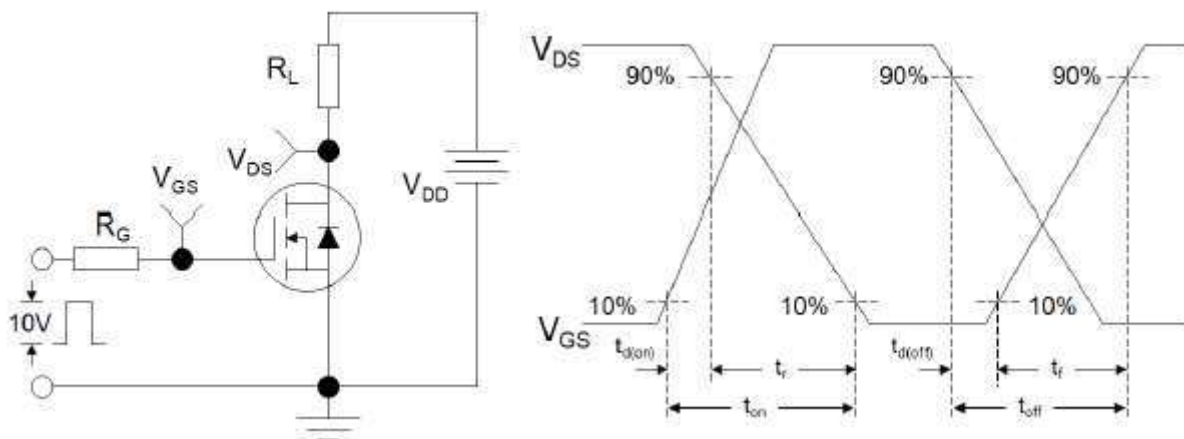

Figure 2: Resistive Switching Test Circuit & Waveforms

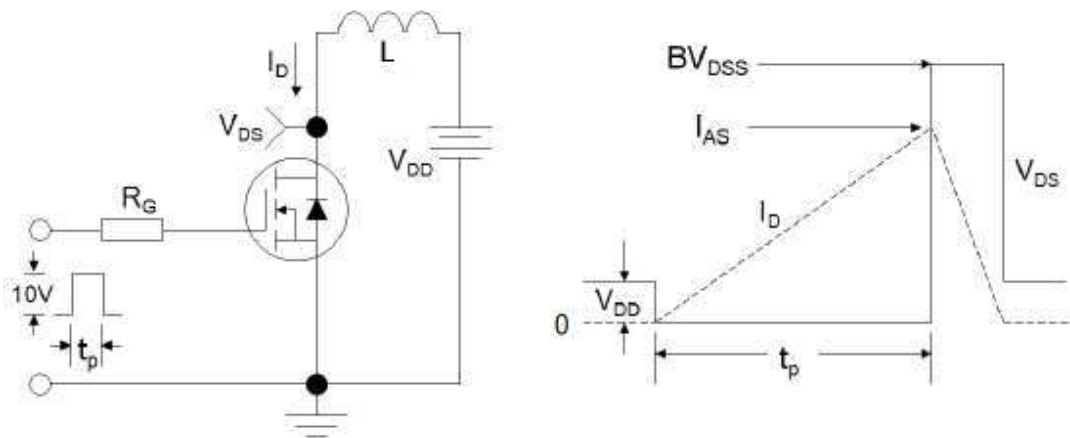

Figure 3:Unclamped Inductive Switching Test Circuit & Waveforms

Typical Performance Characteristics

Figure 1: Output Characteristics

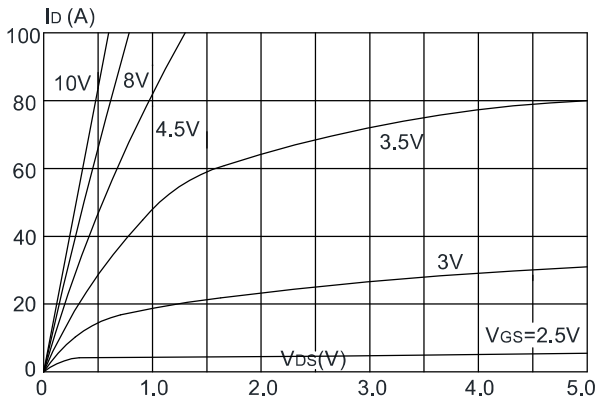

Figure 2: Typical Transfer Characteristics

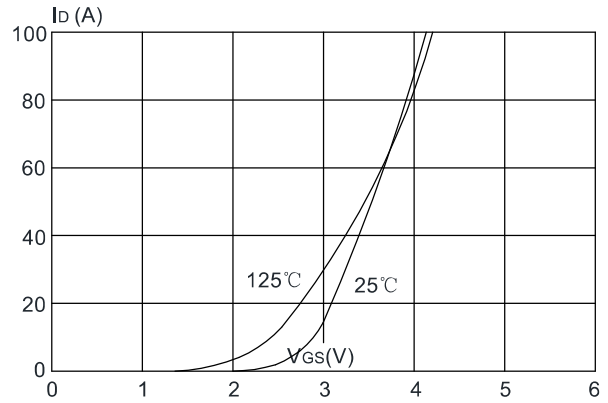

Figure 3: On-resistance vs. Drain Current

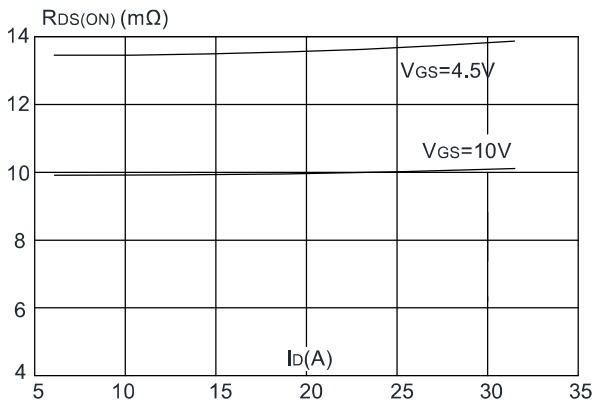

Figure 4: Body Diode Characteristics

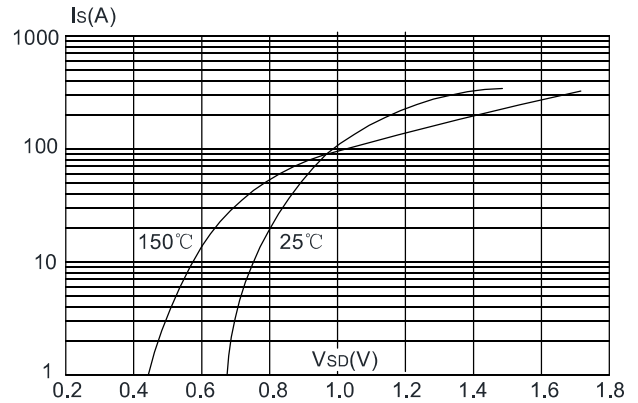

Figure 5: Gate Charge Characteristics

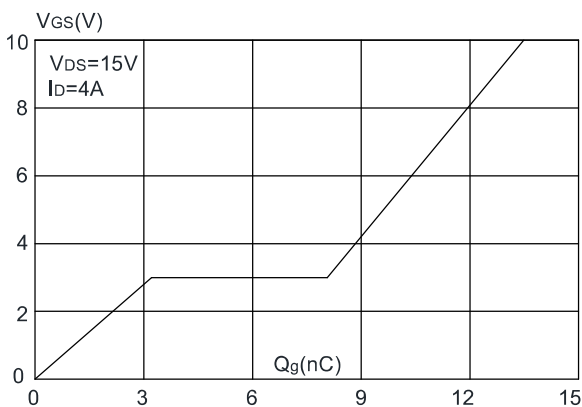

Figure 6: Capacitance Characteristics

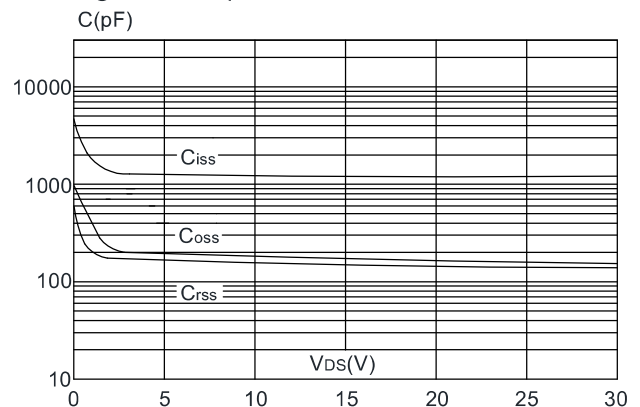

Figure 7: Normalized Breakdown Voltage vs. Junction Temperature

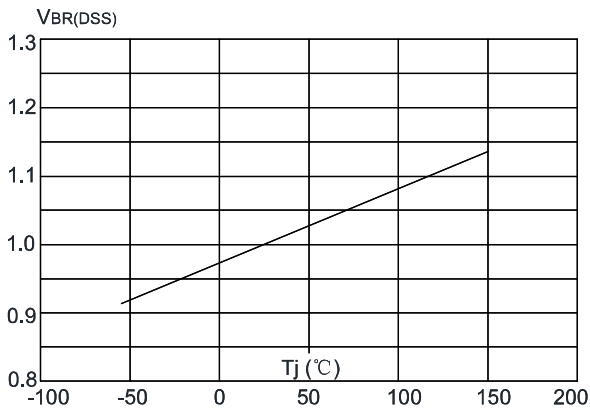

Figure 8: Normalized on Resistance vs. Junction Temperature

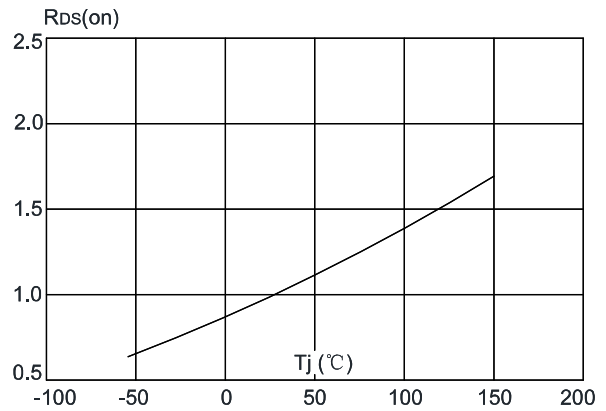

Figure 9: Maximum Safe Operating Area

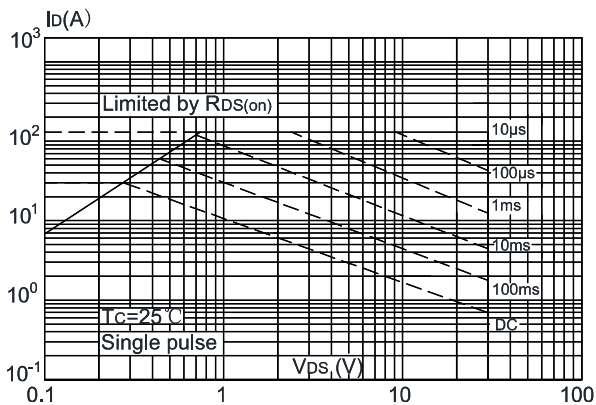

Figure 10: Maximum Continuous Drain Current vs. Case Temperature

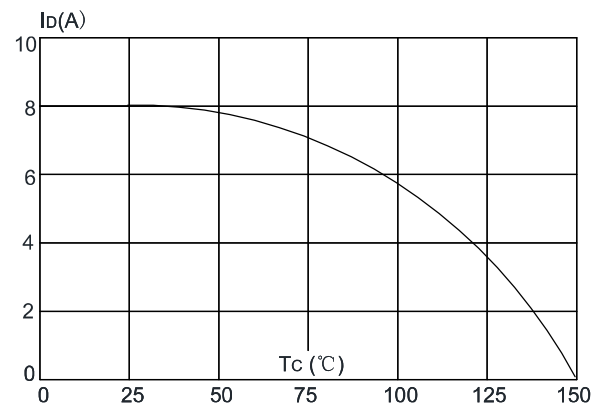
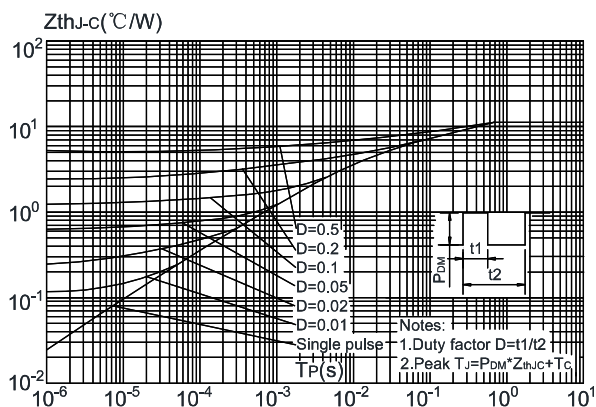
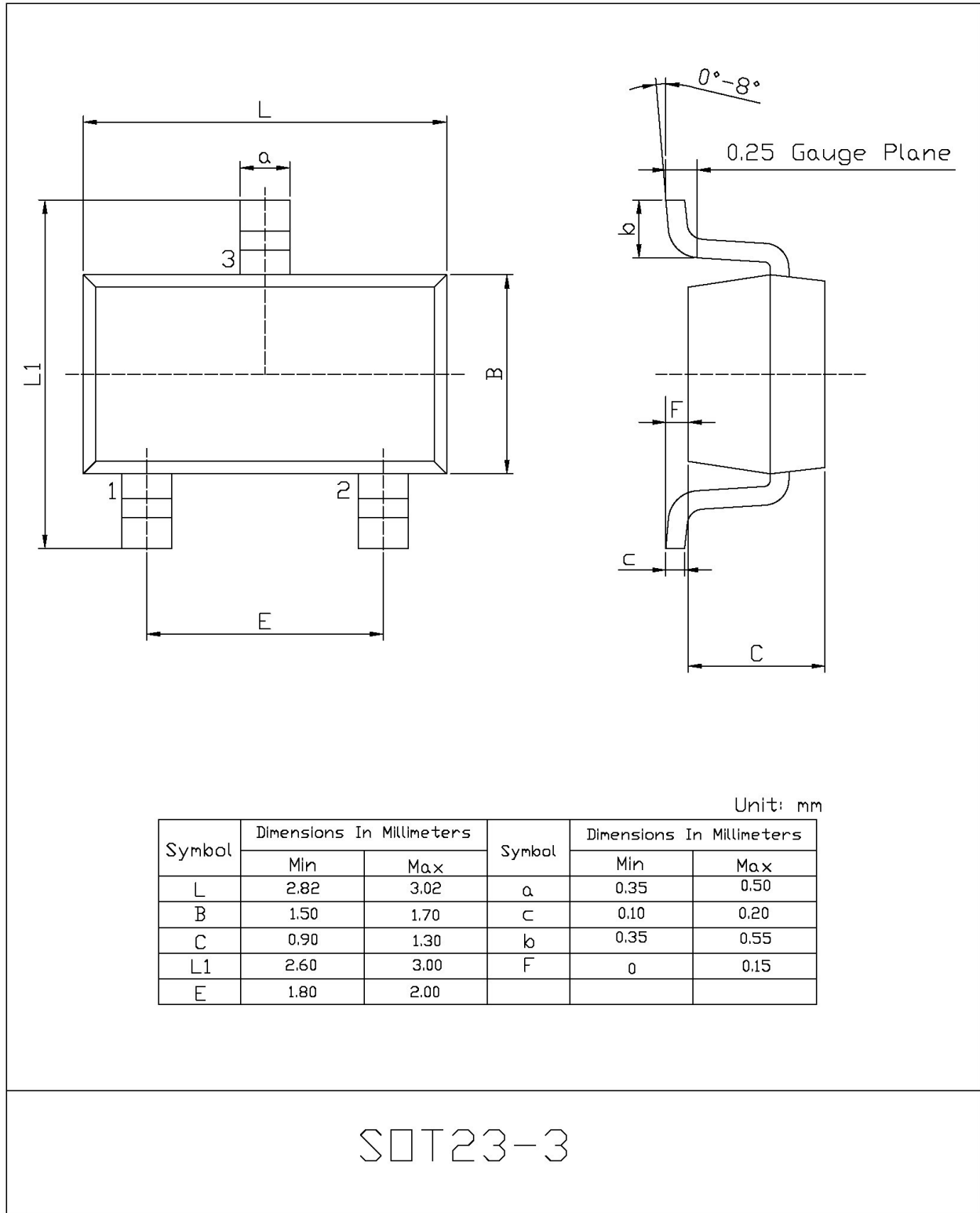

Figure.11: Maximum Effective Transient Thermal Impedance, Junction-to-Case



SOT-23-3 Package Information



X-ON Electronics

Largest Supplier of Electrical and Electronic Components

Click to view similar products for [MOSFET](#) category:

Click to view products by [Quan Li](#) manufacturer:

Other Similar products are found below :

[IRFD120](#) [JANTX2N5237](#) [2SK2267\(Q\)](#) [BUK455-60A/B](#) [TK100A10N1,S4X\(S](#) [MIC4420CM-TR](#) [VN1206L](#) [NDP4060](#) [SI4482DY](#)
[IRS2092STRPBF-EL](#) [IPS70R2K0CEAKMA1](#) [TK31J60W5,S1VQ\(O](#) [TK31J60W,S1VQ\(O](#) [TK16J60W,S1VQ\(O](#) [2SK2614\(TE16L1,Q\)](#)
[DMN1017UCP3-7](#) [EFC2J004NUZTDG](#) [P85W28HP2F-7071](#) [DMN1053UCP4-7](#) [NTE2384](#) [DMC2700UDMQ-7](#) [DMN2080UCB4-7](#)
[DMN61D9UWQ-13](#) [US6M2GTR](#) [DMN31D5UDJ-7](#) [DMP22D4UFO-7B](#) [IPS60R3K4CEAKMA1](#) [DMN1006UCA6-7](#) [DMN16M9UCA6-7](#)
[STF5N65M6](#) [IRF40H233XTMA1](#) [STU5N65M6](#) [DMN6022SSD-13](#) [DMN13M9UCA6-7](#) [DMTH10H4M6SPS-13](#) [IPS60R360PFD7SAKMA1](#)
[DMN2990UFB-7B](#) [SSM3K35CT,L3F](#) [IPLK60R1K0PFD7ATMA1](#) [2N7002W-G](#) [MCAC30N06Y-TP](#) [IPWS65R035CFD7AXKSA1](#)
[MCQ7328-TP](#) [SSM3J143TU,LXHF](#) [DMN12M3UCA6-7](#) [PJMF280N65E1_T0_00201](#) [PJMF380N65E1_T0_00201](#)
[PJMF280N60E1_T0_00201](#) [PJMF600N65E1_T0_00201](#) [PJMF900N65E1_T0_00201](#)