

Feature

- 500V,3A
 $R_{DS(ON)} < 3.0 \Omega @ V_{GS}=10V$ TYP:2.6 Ω
- Fast Switching
- Lead free product is acquired
- Excellent $R_{DS(ON)}$ and Low Gate Charge

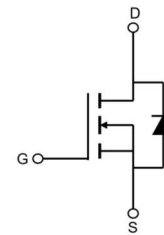

Schematic Diagram



Marking and pin assignment

Application

- PWM applications
- Load Switch
- Power management

Package Marking and Ordering Information

Device Marking	Device	Device Package	Reel Size	Tape width	Quantity (PCS)
3N50K	AP3N50K	TO-252	13 inch	-	2500

ABSOLUTE MAXIMUM RATINGS ($T_a=25^\circ\text{C}$ unless otherwise noted)

Parameter	Symbol	Value	Unit
Drain-Source Voltage	V_{DS}	500	V
Gate-Source Voltage	V_{GS}	± 30	V
Continuous Drain Current ($T_a=25^\circ\text{C}$)	I_D	3	A
Continuous Drain Current ($T_a=100^\circ\text{C}$)	I_D	1.8	A
Pulsed Drain Current ⁽¹⁾	I_{DM}	12	A
Single Pulsed Avalanche Energy ⁽²⁾	E_{AS}	45	mJ
Power Dissipation	P_D	50	W
Thermal Resistance from Junction to Case	$R_{\theta JC}$	2.5	$^\circ\text{C}/\text{W}$
Junction Temperature	T_J	150	$^\circ\text{C}$
Storage Temperature	T_{STG}	-55~ +150	$^\circ\text{C}$

MOSFET ELECTRICAL CHARACTERISTICS(T_a=25°C unless otherwise noted)

Parameter	Symbol	Test Condition	Min	Type	Max	Unit
Static Characteristics						
Drain-source breakdown voltage	V _{(BR)DSS}	V _{GS} = 0V, I _D =250μA	500	-	-	V
Zero gate voltage drain current	I _{DSS}	V _{DS} =500V, V _{GS} = 0V	-	-	1	μA
Gate-body leakage current	I _{GSS}	V _{GS} =±30V, V _{DS} = 0V	-	-	±100	nA
Gate threshold voltage ⁽³⁾	V _{GS(th)}	V _{DS} =V _{GS} , I _D =250μA	2	3.1	4	V
Drain-source on-resistance ⁽³⁾	R _{DS(on)}	V _{GS} =10V, I _D =1.5A	-	2.6	3.0	Ω
Forward tranconductance ⁽³⁾	g _{FS}	V _{DS} =10V, I _D =1.5A	0.5	-	-	S
Dynamic characteristics						
Input Capacitance	C _{iss}	V _{DS} =25V, V _{GS} =0V, f =1MHz	-	278	-	pF
Output Capacitance	C _{oss}		-	20	-	
Reverse Transfer Capacitance	C _{rss}		-	5	-	
Switching characteristics						
Turn-off delay time	t _{d(off)}	V _{DD} =300V, I _D =3A, V _{GS} =10V, R _G =25Ω	-	13	-	ns
Total Gate Charge	Q _g	V _{DS} =480V, I _D =1A, V _{GS} =10V	-	4.8	-	nC
Gate-Source Charge	Q _{gs}		-	0.7	-	
Gate-Drain Charge	Q _{gd}		-	2.7	-	
Source-Drain Diode characteristics						
Diode Forward voltage ⁽³⁾	V _{DS}	V _{GS} =0V, I _S =3A	-	-	1.4	V
Diode Forward current ⁽⁴⁾	I _S		-	-	3	A
Body Diode Reverse Recovery Time	t _{rr}	T _J =25° , IF=3A, di/dt=100A/us		190		ns
Body Diode Reverse Recovery Charge	Q _{rr}	T _J =25° , IF=3A, di/dt=100A/us		0.53		uc

Notes:

1. Repetitive Rating: pulse width limited by maximum junction temperature
2. EAS Condition: T_J=25°C, V_{DD}=50V, R_G=2.0 Ω, L=10mH
3. Pulse Test: pulse width≤300μs, duty cycle≤2%
4. Surface Mounted on FR4 Board, t≤10 sec

Typical Characteristics

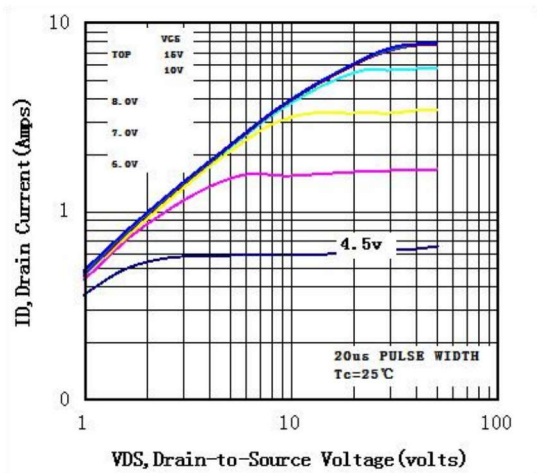

Fig1 Typical Output Characteristics, $T_c=25^\circ\text{C}$

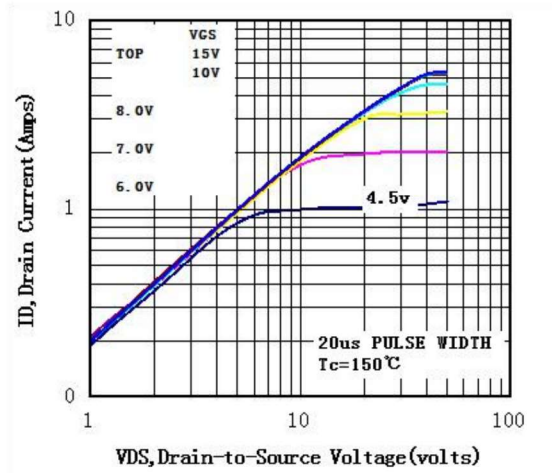

Fig2 Typical Output Characteristics, $T_c=150^\circ\text{C}$

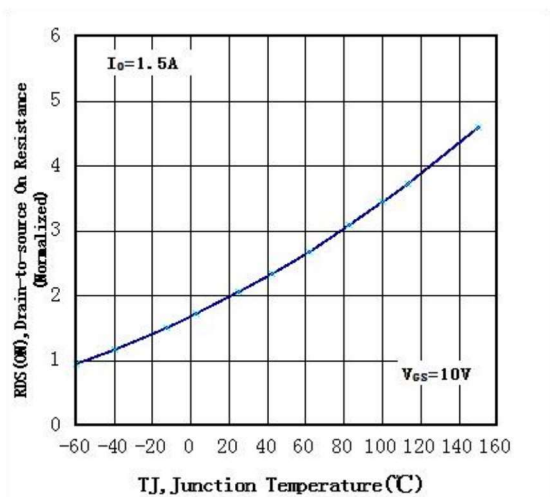

Fig3 Normalized On-Resistance Vs. Temperature

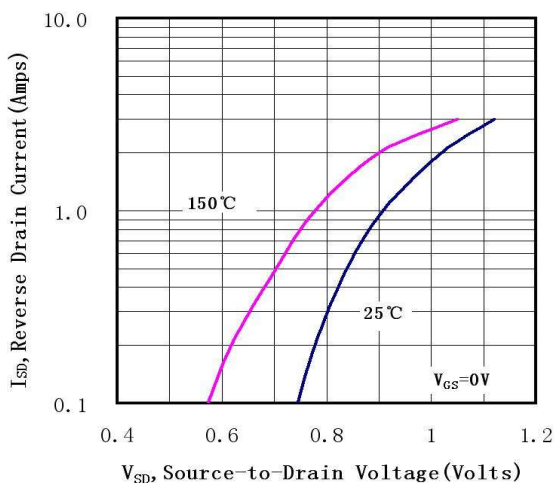

Fig4 Typical Source-Drain Diode Forward Voltage

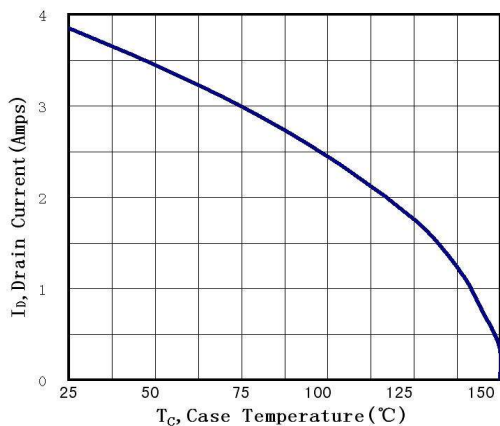

Fig5 Maximum Drain Current Vs. Case Temperature

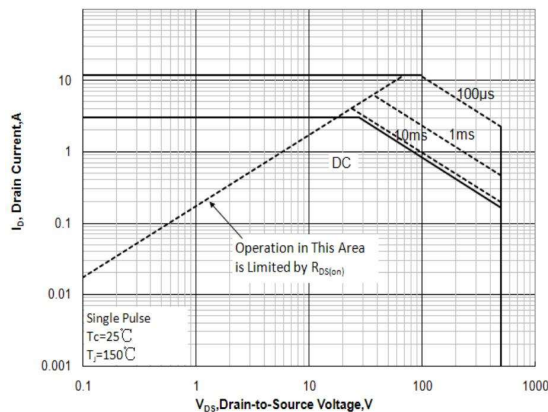
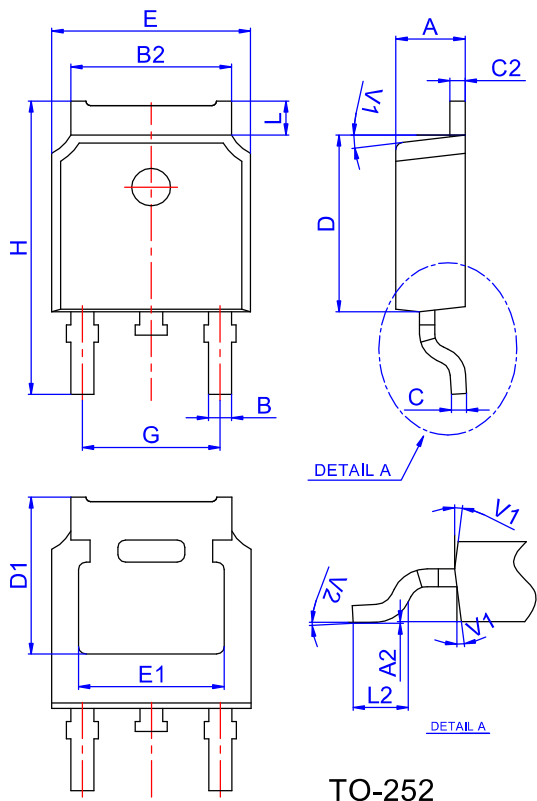

Fig6 Maximum Safe Operating Area

TO-252 Package Information



Ref.	Dimensions					
	Millimeters			Inches		
	Min.	Typ.	Max.	Min.	Typ.	Max.
A	2.10		2.50	0.083		0.098
A2	0		0.10	0		0.004
B	0.66		0.86	0.026		0.034
B2	5.18		5.48	0.202		0.216
C	0.40		0.60	0.016		0.024
C2	0.44		0.58	0.017		0.023
D	5.90		6.30	0.232		0.248
D1	5.30REF			0.209REF		
E	6.40		6.80	0.252		0.268
E1	4.63			0.182		
G	4.47		4.67	0.176		0.184
H	9.50		10.70	0.374		0.421
L	1.09		1.21	0.043		0.048
L2	1.35		1.65	0.053		0.065
V1		7°			7°	
V2	0°		6°	0°		6°

Reel Specification-TO-252

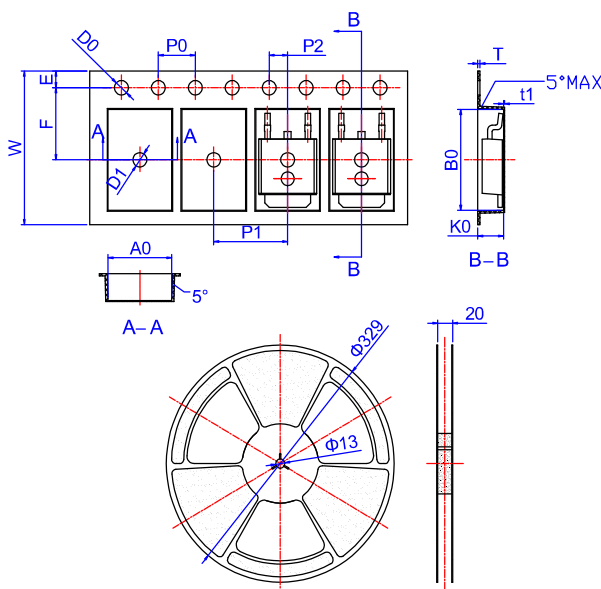

Ref.	Dimensions					
	Millimeters			Inches		
	Min.	Typ.	Max.	Min.	Typ.	Max.
W	15.90	16.00	16.10	0.626	0.630	0.634
E	1.65	1.75	1.85	0.065	0.069	0.073
F	7.40	7.50	7.60	0.291	0.295	0.299
D0	1.40	1.50	1.60	0.055	0.059	0.063
D1	1.40	1.50	1.60	0.055	0.059	0.063
P0	3.90	4.00	4.10	0.154	0.157	0.161
P1	7.90	8.00	8.10	0.311	0.315	0.319
P2	1.90	2.00	2.10	0.075	0.079	0.083
A0	6.85	6.90	7.00	0.270	0.271	0.276
B0	10.45	10.50	10.60	0.411	0.413	0.417
K0	2.68	2.78	2.88	0.105	0.109	0.113
T	0.24		0.27	0.009		0.011
t1	0.10			0.004		
10P0	39.80	40.00	40.20	1.567	1.575	1.583

X-ON Electronics

Largest Supplier of Electrical and Electronic Components

Click to view similar products for [MOSFET](#) category:

Click to view products by [Quan Li](#) manufacturer:

Other Similar products are found below :

[IRFD120](#) [JANTX2N5237](#) [BUK455-60A/B](#) [MIC4420CM-TR](#) [VN1206L](#) [NDP4060](#) [SI4482DY](#) [IPS70R2K0CEAKMA1](#) [SQD23N06-31L-GE3](#)
[TK16J60W,S1VQ\(O](#) [2SK2614\(TE16L1,Q\)](#) [DMN1017UCP3-7](#) [DMN1053UCP4-7](#) [SQJ469EP-T1-GE3](#) [NTE2384](#) [DMC2700UDMQ-7](#)
[DMN2080UCB4-7](#) [DMN61D9UWQ-13](#) [US6M2GTR](#) [DMN31D5UDJ-7](#) [DMP22D4UFO-7B](#) [DMN1006UCA6-7](#) [DMN16M9UCA6-7](#)
[STF5N65M6](#) [IRF40H233XTMA1](#) [STU5N65M6](#) [DMN6022SSD-13](#) [DMN13M9UCA6-7](#) [DMTH10H4M6SPS-13](#) [DMN2990UFB-7B](#)
[IPB80P04P405ATMA2](#) [2N7002W-G](#) [MCAC30N06Y-TP](#) [MCQ7328-TP](#) [NTMC083NP10M5L](#) [BXP7N65D](#) [BXP4N65F](#) [AOL1454G](#)
[WMJ80N60C4](#) [BXP2N20L](#) [BXP2N65D](#) [BXT1150N10J](#) [BXT1700P06M](#) [TSM60NB380CP](#) [ROG](#) [RQ7L055BGTGR](#) [DMNH15H110SK3-13](#)
[SLF10N65ABV2](#) [BSO203SP](#) [BSO211P](#) [IPA60R230P6](#)