

Feature

- 40V,10A
 $R_{DS(on)} < 22m\Omega @ V_{GS}=10V$
 $R_{DS(on)} < 30m\Omega @ V_{GS}=4.5V$
- Trench DMOS Power MOSFET
- Fast Switching
- Exceptional on-resistance and maximum DC current capability

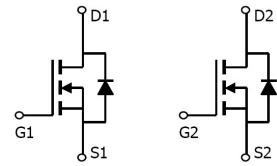

Schematic diagram

Application

- DC/DC Converter
- Load Switch for Portable Devices
- Battery Switch

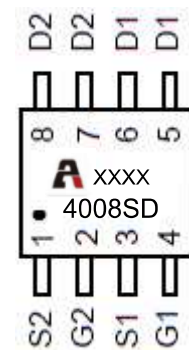

Marking and pin assignment

Package Marking and Ordering Information

Device Marking	Device	Device Package	Reel Size	Tape width	Quantity (PCS)
4008SD	AP4008SD	SOP-8	13 inch	-	4000

ABSOLUTE MAXIMUM RATINGS (T_a=25°C unless otherwise noted)

Parameter	Symbol	Value	Unit
Drain-Source Voltage	V _{DS}	40	V
Gate-Source Voltage	V _{GS}	±20	V
Continuous Drain Current (T _a =25°C)	I _D	10	A
Continuous Drain Current (T _a =100°C)	I _D	6.5	A
Pulsed Drain Current ⁽¹⁾	I _{DM}	40	A
Power Dissipation	P _D	4	W
Thermal Resistance from Junction to Ambient	R _{θJA}	31.3	°C/W
Junction Temperature	T _J	150	°C
Storage Temperature	T _{STG}	-55~ +150	°C

MOSFET ELECTRICAL CHARACTERISTICS(T_a=25°C unless otherwise noted)

Parameter	Symbol	Test Condition	Min	Type	Max	Unit
Static Characteristics						
Drain-source breakdown voltage	V _{(BR)DSS}	V _{GS} = 0V, I _D =250μA	40	-	-	V
Zero gate voltage drain current	I _{DSS}	V _{DS} =40V, V _{GS} = 0V	-	-	1	μA
Gate-body leakage current	I _{GSS}	V _{GS} =±20V, V _{DS} = 0V	-	-	±100	nA
Gate threshold voltage ⁽²⁾	V _{GS(th)}	V _{DS} =V _{GS} , I _D =250μA	1	1.6	2.5	V
Drain-source on-resistance ⁽²⁾	R _{DS(on)}	V _{GS} =10V, I _D =10A	-	17	22	mΩ
		V _{GS} =4.5V, I _D =6A	-	22	30	
Dynamic characteristics						
Input Capacitance	C _{iss}	V _{DS} =20V, V _{GS} =0V, f =1MHz	-	1050	-	pF
Output Capacitance	C _{oss}		-	84	-	
Reverse Transfer Capacitance	C _{rss}		-	72	-	
Switching characteristics						
Turn-on delay time	t _{d(on)}	V _{DD} =20V, R _L =1.5Ω V _{GS} =10V, R _G =3Ω	-	11	-	ns
Turn-on rise time	t _r		-	13	-	
Turn-off delay time	t _{d(off)}		-	36	-	
Turn-off fall time	t _f		-	9	-	
Total Gate Charge	Q _g	V _{DS} =20V, I _D =5A, V _{GS} =10V	-	11	-	nC
Gate-Source Charge	Q _{gs}		-	1.9	-	
Gate-Drain Charge	Q _{gd}		-	2.2	-	
Source-Drain Diode characteristics						
Diode Forward voltage ⁽²⁾	V _{DS}	V _{GS} =0V, I _S =10A	-	-	1.2	V
Diode Forward current ⁽³⁾	I _S		-	-	40	A

Notes:

1. Repetitive Rating: pulse width limited by maximum junction temperature
2. Pulse Test: pulse width≤300μs, duty cycle≤2%
3. Surface Mounted on FR4 Board,t≤10 sec

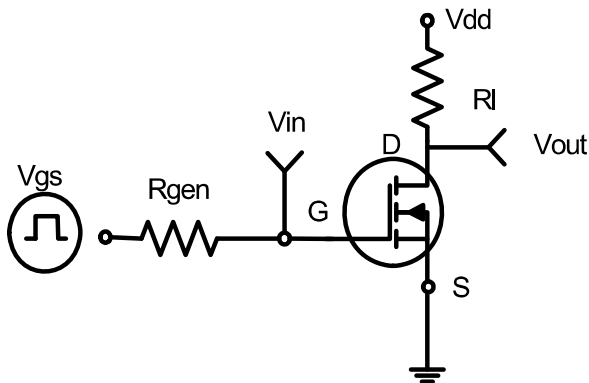

Figure 1: Switching Test Circuit

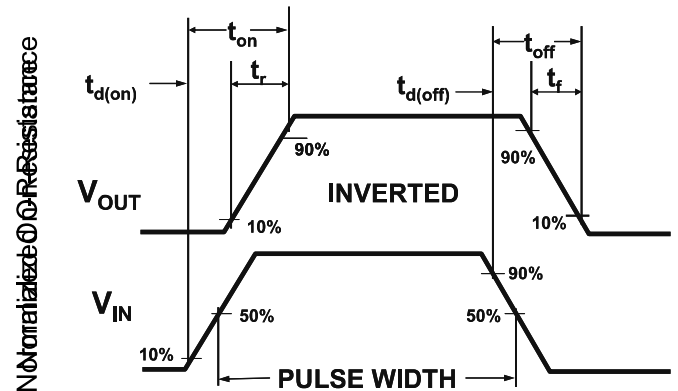

Figure 2: Switching Waveforms

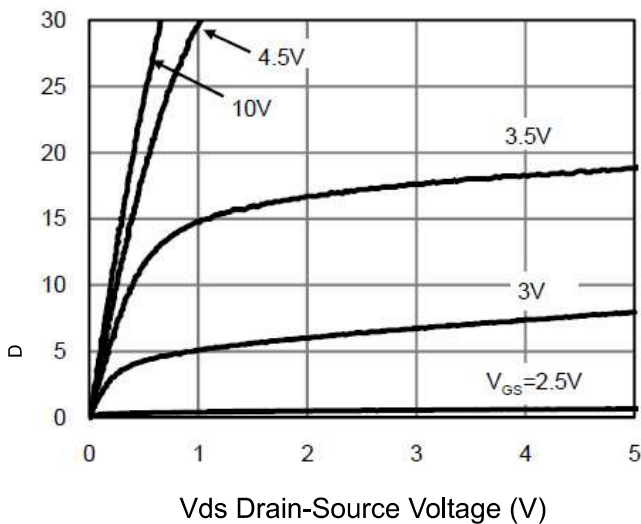

Figure 3 Output Characteristics

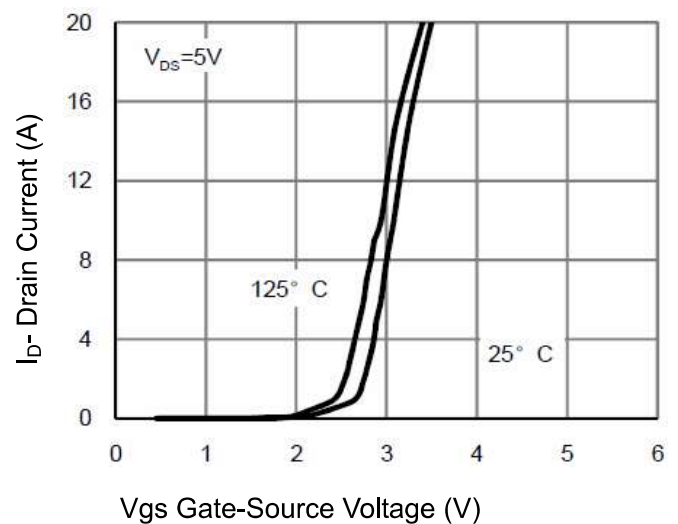

Figure 4 Transfer Characteristics

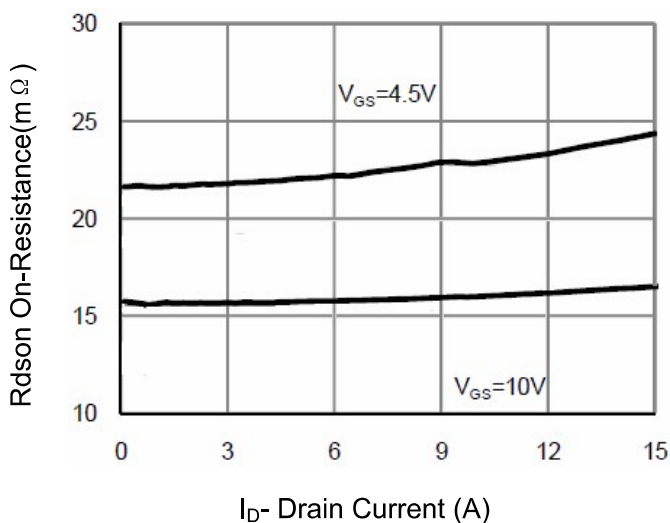

Figure 5 Drain-Source On-Resistance

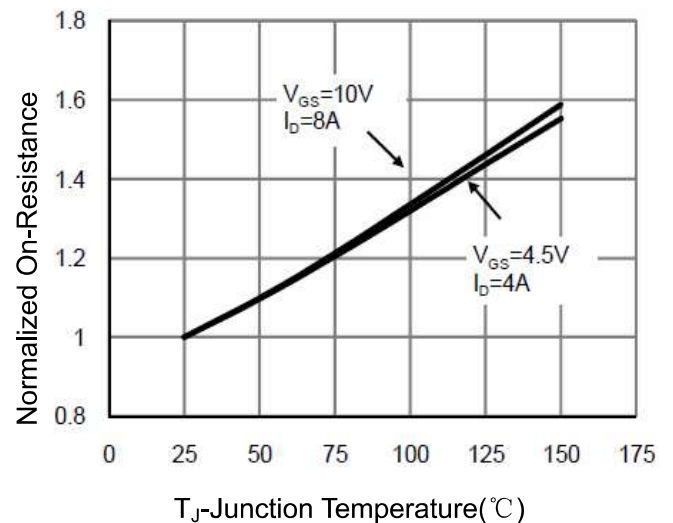
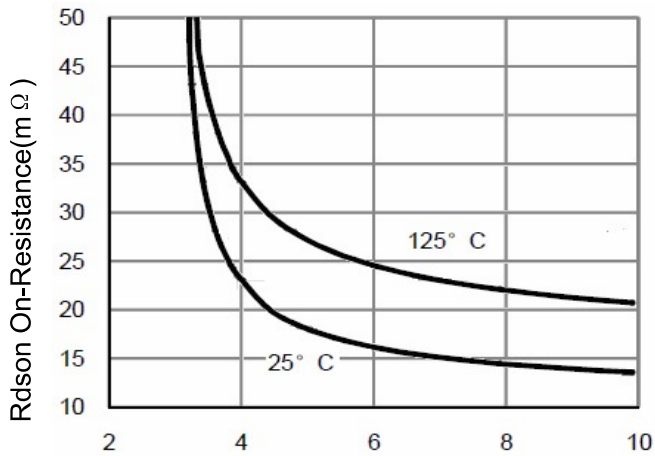
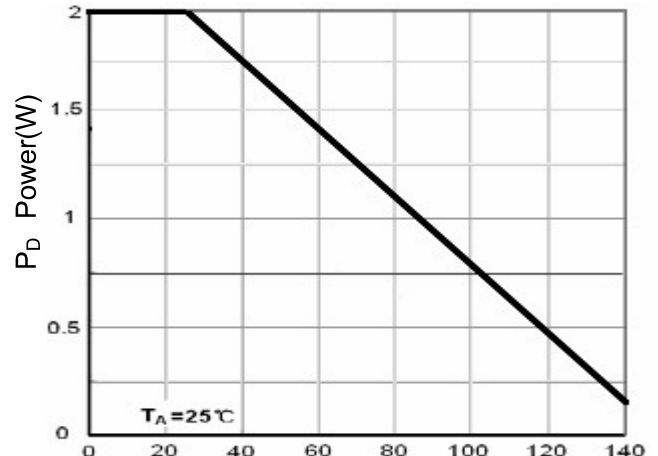

Figure 6 Drain-Source On-Resistance



Vgs Gate-Source Voltage (V)
Figure 7 Rdson vs Vgs



Tj Junction Temperature (°C)
Figure 8 Power Dissipation

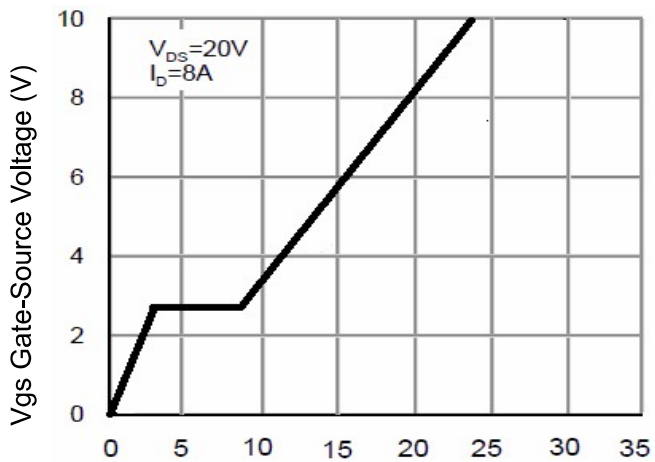

Qg Gate Charge (nC)
Figure 9 Gate Charge

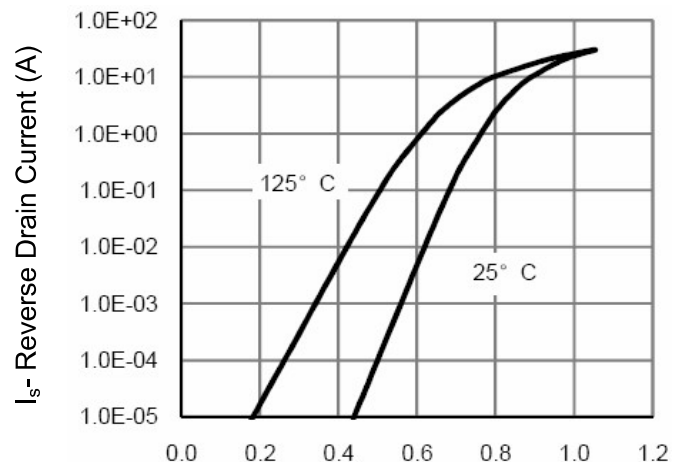

Vds Drain-Source Voltage (V)
Figure 10 Source- Drain Diode Forward

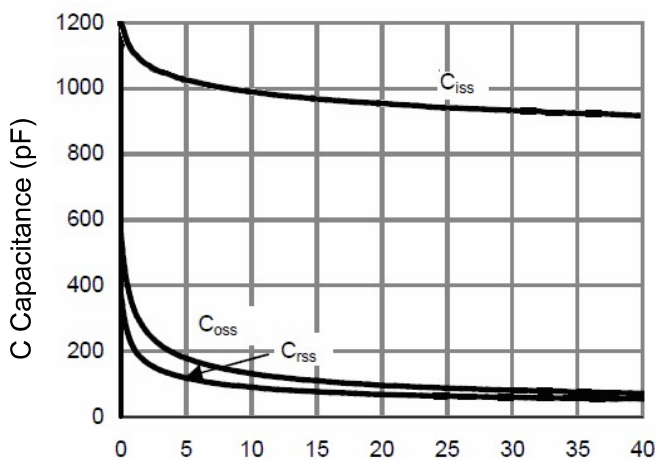

Vds Drain-Source Voltage (V)
Figure 11 Capacitance vs Vds

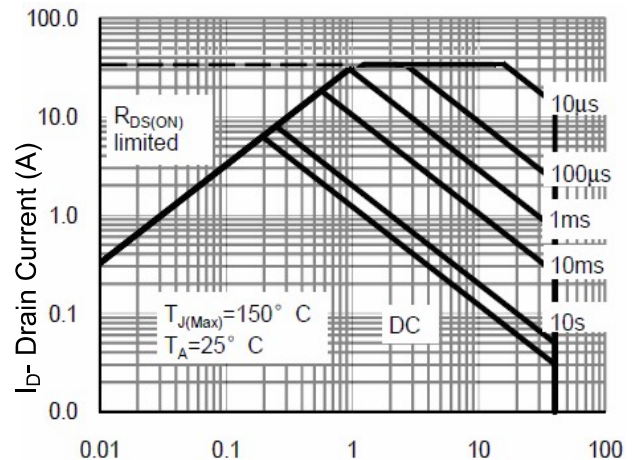

Vds Drain-Source Voltage (V)
Figure 12 Safe Operation Area

SOP-8 Package Information

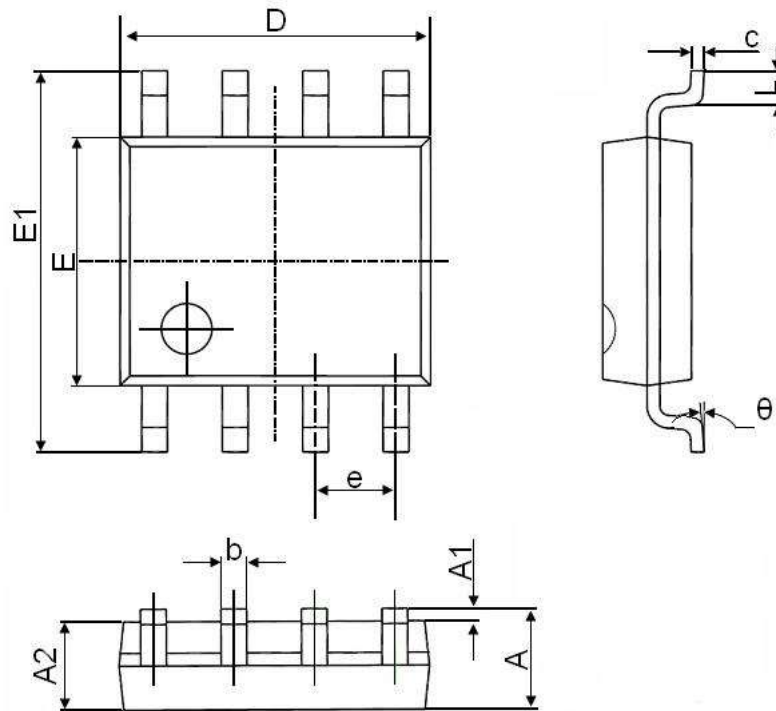

Symbol	Dimensions In Millimeters		Dimensions In Inches	
	Min.	Max.	Min.	Max.
A	1.350	1.750	0.053	0.069
A1	0.100	0.250	0.004	0.010
A2	1.350	1.550	0.053	0.061
b	0.330	0.510	0.013	0.020
c	0.170	0.250	0.006	0.010
D	4.700	5.100	0.185	0.200
E	3.800	4.000	0.150	0.157
E1	5.800	6.200	0.228	0.244
e	1.270(BSC)		0.050(BSC)	
L	0.400	1.270	0.016	0.050
theta	0°	8°	0°	8°

X-ON Electronics

Largest Supplier of Electrical and Electronic Components

Click to view similar products for [MOSFET](#) category:

Click to view products by [Quan Li](#) manufacturer:

Other Similar products are found below :

[IRFD120](#) [JANTX2N5237](#) [2SK2267\(Q\)](#) [BUK455-60A/B](#) [TK100A10N1,S4X\(S](#) [MIC4420CM-TR](#) [VN1206L](#) [NDP4060](#) [SI4482DY](#)
[IRS2092STRPBF-EL](#) [IPS70R2K0CEAKMA1](#) [SQM120N06-3M5L-GE3](#) [TK31J60W5,S1VQ\(O](#) [TK31J60W,S1VQ\(O](#) [TK16J60W,S1VQ\(O](#)
[2SK2614\(TE16L1,Q\)](#) [DMN1017UCP3-7](#) [EFC2J004NUZTDG](#) [P85W28HP2F-7071](#) [NTE2384](#) [DMC2700UDMQ-7](#) [DMN2080UCB4-7](#)
[DMN61D9UWQ-13](#) [US6M2GTR](#) [DMN31D5UDJ-7](#) [DMP22D4UFO-7B](#) [IPS60R3K4CEAKMA1](#) [DMN1006UCA6-7](#) [DMN16M9UCA6-7](#)
[STF5N65M6](#) [IRF40H233XTMA1](#) [STU5N65M6](#) [DMN6022SSD-13](#) [DMN13M9UCA6-7](#) [DMTH10H4M6SPS-13](#) [IPS60R360PFD7SAKMA1](#)
[DMN2990UFB-7B](#) [SSM3K35CT,L3F](#) [IPLK60R1K0PFD7ATMA1](#) [2N7002W-G](#) [MCAC30N06Y-TP](#) [IPWS65R035CFD7AXKSA1](#)
[MCQ7328-TP](#) [SSM3J143TU,LXHF](#) [PJMF280N65E1_T0_00201](#) [PJMF380N65E1_T0_00201](#) [PJMF280N60E1_T0_00201](#)
[PJMF600N65E1_T0_00201](#) [PJMF900N65E1_T0_00201](#) [PJMF900N60E1_T0_00201](#)