

# AP4085G

## N-Channel Power MOSFET

### Features

- 40V,50A  
 $R_{DS(ON)} < 8.5m\Omega @ V_{GS} = 10V$   
 $R_{DS(ON)} < 15m\Omega @ V_{GS} = 4.5V$
- Lead free and Green Device Available
- Excellent  $R_{DS(ON)}$  and Low Gate Charge
- Lead free product is acquired

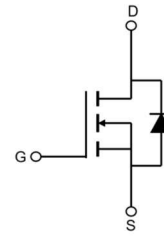

Schematic Diagram

### Application

- Load Switch
- PWM Application
- Power management

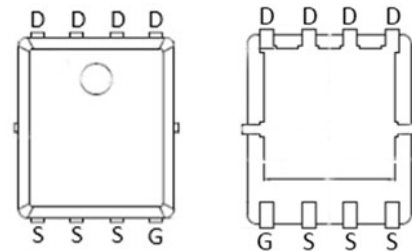

PDFN5X6-8L

### Absolute Maximum Ratings ( $T_C=25^\circ\text{C}$ unless otherwise specified)

Symbol	Parameter	Max.	Units
$V_{DSS}$	Drain-Source Voltage	40	V
$V_{GSS}$	Gate-Source Voltage	$\pm 20$	V
$I_D$	Continuous Drain Current	$T_C = 25^\circ\text{C}$	50
		$T_C = 100^\circ\text{C}$	33
$I_{DM}$	Pulsed Drain Current <sup>note1</sup>	125	A
$E_{AS}$	Single Pulsed Avalanche Energy <sup>note2</sup>	48	mJ
$P_D$	Power Dissipation	$T_C = 25^\circ\text{C}$	27.8
$R_{\theta JC}$	Thermal Resistance, Junction to Case	3.2	$^\circ\text{C/W}$
$T_J, T_{STG}$	Operating and Storage Temperature Range	-55 to +150	$^\circ\text{C}$

**AP4085G**
**N-Channel Power MOSFET**
**Electrical Characteristics** ( $T_J=25^{\circ}\text{C}$  unless otherwise specified)

Symbol	Parameter	Test Condition	Min.	Typ.	Max.	Units
<b>Off Characteristic</b>						
$V_{(BR)DSS}$	Drain-Source Breakdown Voltage	$V_{GS}=0V, I_D=250\mu A$	40	-	-	V
$I_{DSS}$	Zero Gate Voltage Drain Current	$V_{DS}=40V, V_{GS}=0V,$	-	-	1.0	$\mu A$
$I_{GSS}$	Gate to Body Leakage Current	$V_{DS}=0V, V_{GS}=\pm 20V$	-	-	$\pm 100$	nA
<b>On Characteristics</b>						
$V_{GS(th)}$	Gate Threshold Voltage	$V_{DS}=V_{GS}, I_D=250\mu A$	1.0	1.5	2.5	V
$R_{DS(on)}$	Static Drain-Source on-Resistance <small>note3</small>	$V_{GS}=10V, I_D=12A$	-	6.9	8.5	m $\Omega$
		$V_{GS}=4.5V, I_D=10A$	-	10.5	15	
<b>Dynamic Characteristics</b>						
$C_{iss}$	Input Capacitance	$V_{DS}=15V, V_{GS}=0V,$ $f=1.0\text{MHz}$	-	690	-	pF
$C_{oss}$	Output Capacitance		-	195	-	pF
$C_{rss}$	Reverse Transfer Capacitance		-	38	-	pF
$Q_g$	Total Gate Charge	$V_{DS}=20V, I_D=12A,$ $V_{GS}=4.5V$	-	5.8	-	nC
$Q_{gs}$	Gate-Source Charge		-	3	-	nC
$Q_{gd}$	Gate-Drain("Miller") Charge		-	1.2	-	nC
<b>Switching Characteristics</b>						
$t_{d(on)}$	Turn-on Delay Time	$V_{DD}=15V, I_D=1A,$ $R_L=1\Omega, R_{GEN}=3\Omega,$ $V_{GS}=10V$	-	14.3	-	ns
$t_r$	Turn-on Rise Time		-	5.6	-	ns
$t_{d(off)}$	Turn-off Delay Time		-	20	-	ns
$t_f$	Turn-off Fall Time		-	11	-	ns
<b>Drain-Source Diode Characteristics and Maximum Ratings</b>						
$I_S$	Maximum Continuous Drain to Source Diode Forward Current		-	-	30	A
$I_{SM}$	Maximum Pulsed Drain to Source Diode Forward Current		-	-	125	A
$V_{SD}$	Drain to Source Diode Forward Voltage	$V_{GS}=0V, I_S=10A$	-	-	1.2	V

- Notes: 1. Repetitive Rating: Pulse Width Limited by Maximum Junction Temperature  
 2. EAS condition:  $T_J=25^{\circ}\text{C}$ ,  $V_{DD}=25V$ ,  $R_G=25\Omega$ ,  $L=0.1\text{mH}$ ,  $I_{AS}=31A$   
 3. Pulse Test: Pulse Width $\leq 300\mu s$ , Duty Cycle $\leq 0.5\%$

### Typical Characteristics

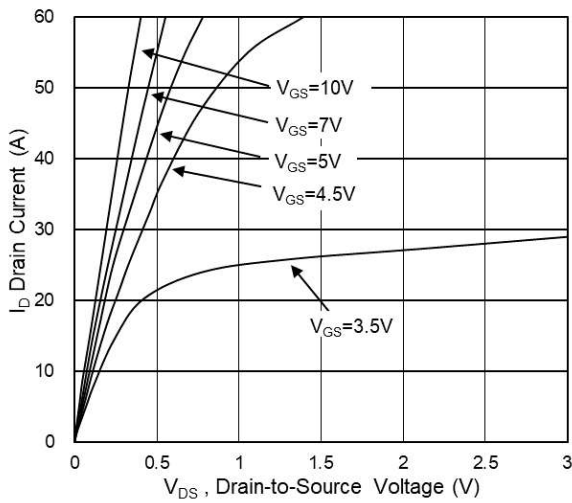

Fig.1 Typical Output Characteristics

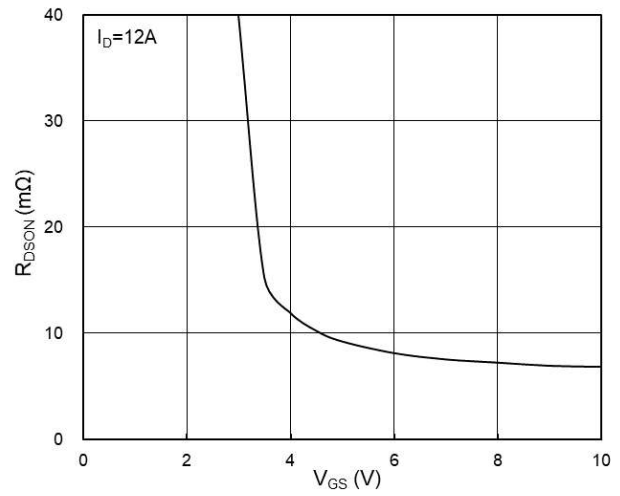

Fig.2 On-Resistance vs G-S Voltage

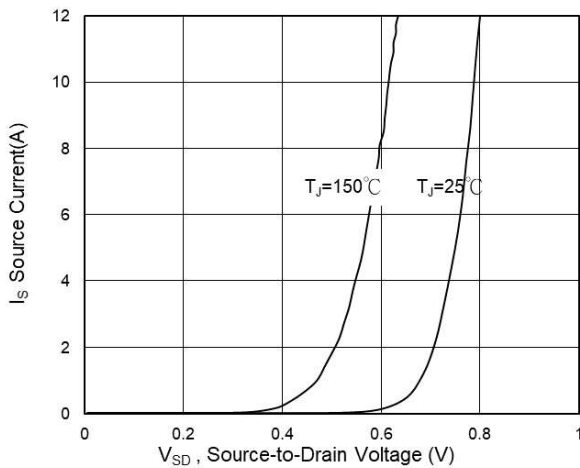

Fig.3 Source Drain Forward Characteristics

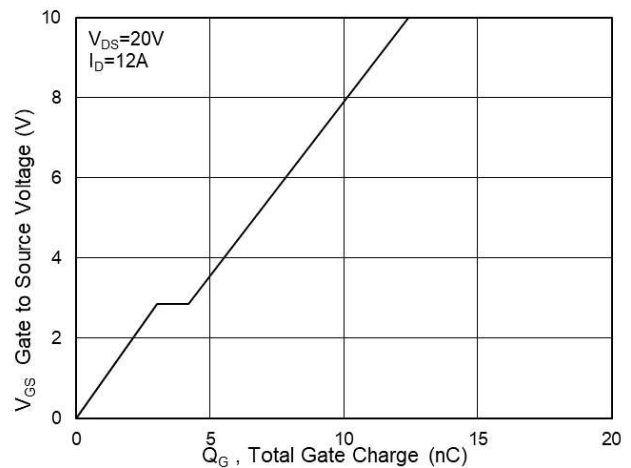

Fig.4 Gate-Charge Characteristics

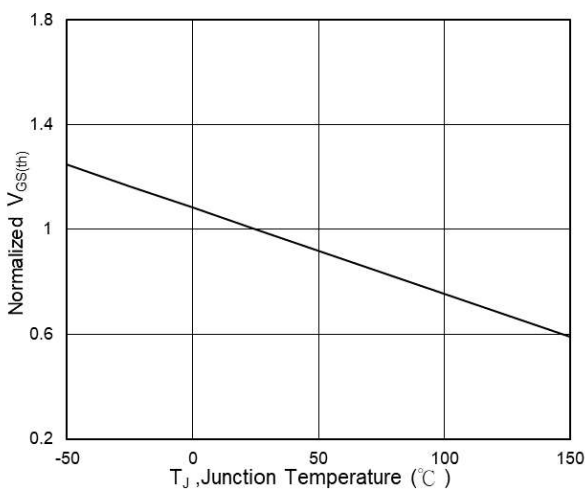

Fig.5 Normalized  $V_{GS(th)}$  vs  $T_J$

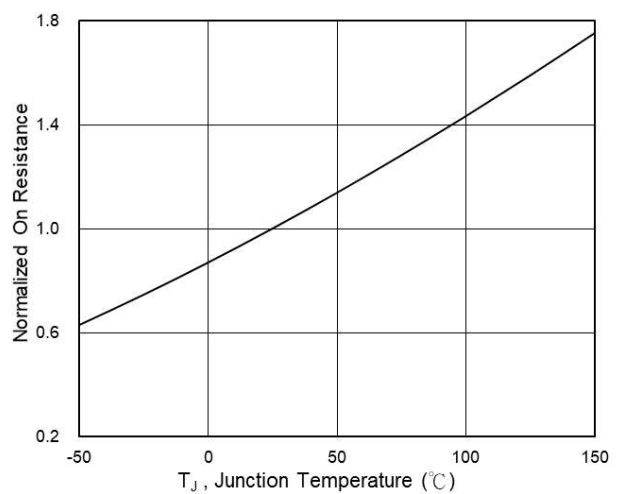
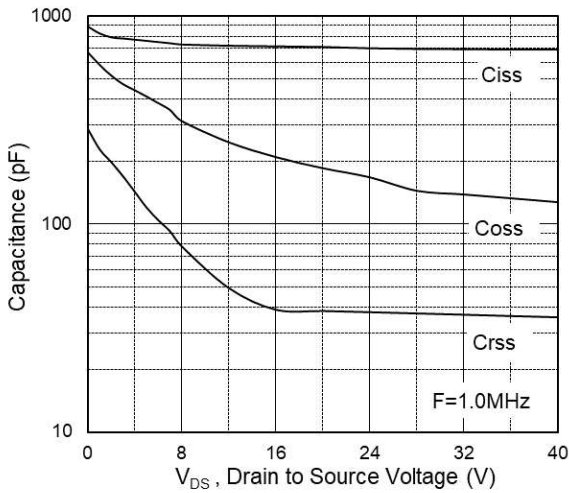

Fig.6 Normalized  $R_{DS(on)}$  vs  $T_J$

**AP4085G**

**N-Channel Power MOSFET**



**Fig.7 Capacitance**

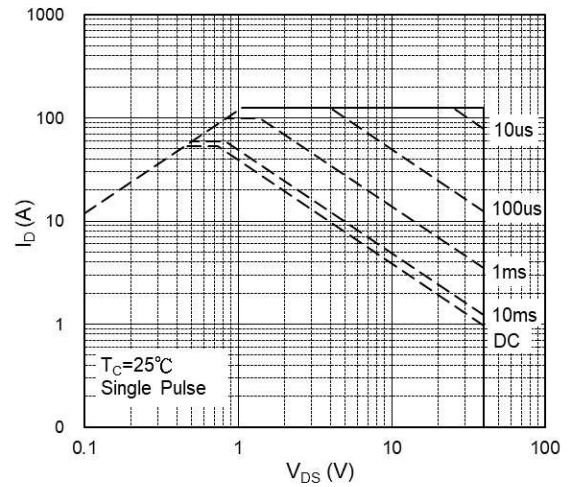

**Fig.8 Safe Operating Area**

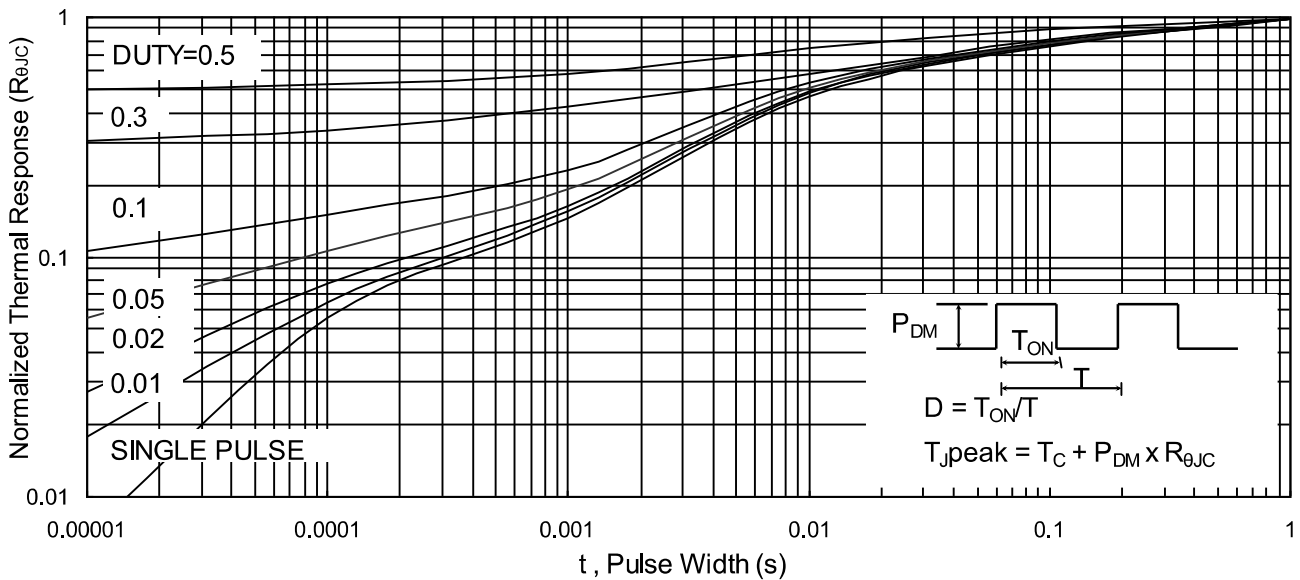

**Fig.9 Normalized Maximum Transient Thermal Impedance**

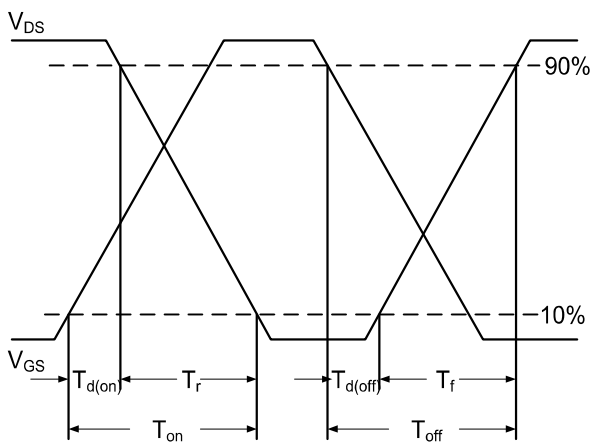

**Fig.10 Switching Time Waveform**

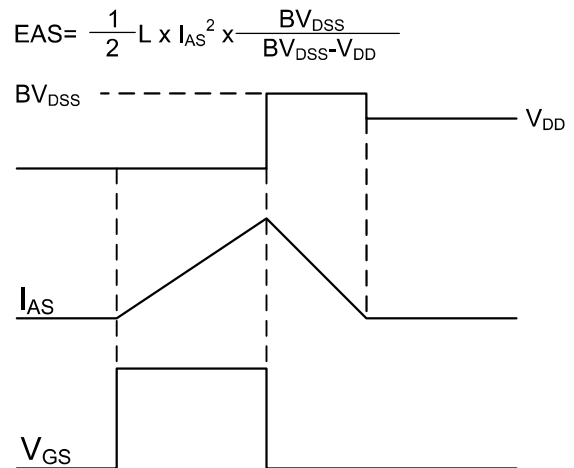
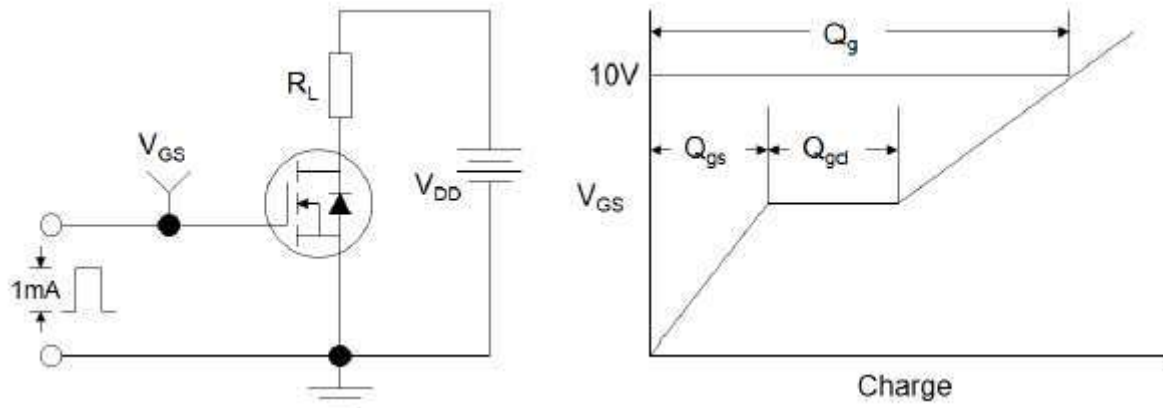

**Fig.11 Unclamped Inductive Waveform**

**AP4085G**

**N-Channel Power MOSFET**

**Test Circuit**



**Figure 1: Gate Charge Test Circuit & Waveform**

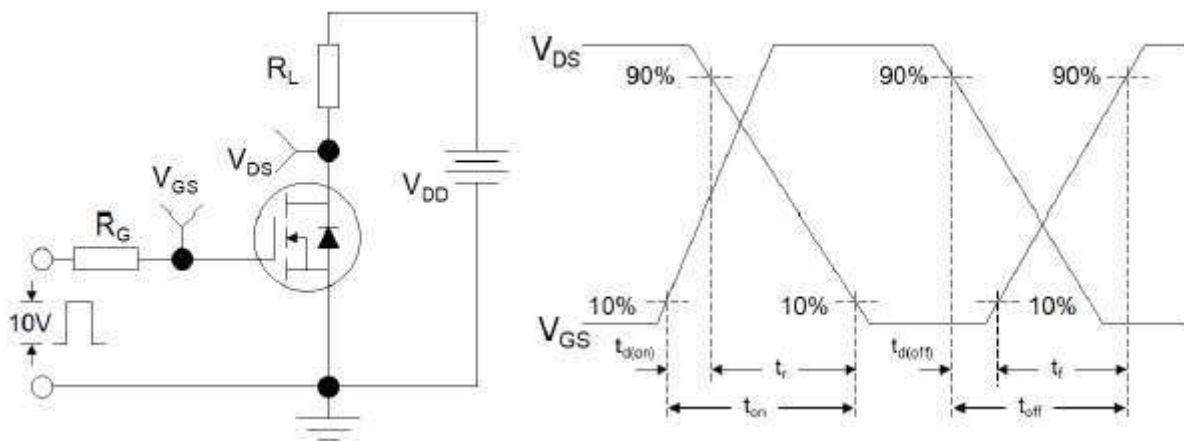

**Figure 2: Resistive Switching Test Circuit & Waveforms**

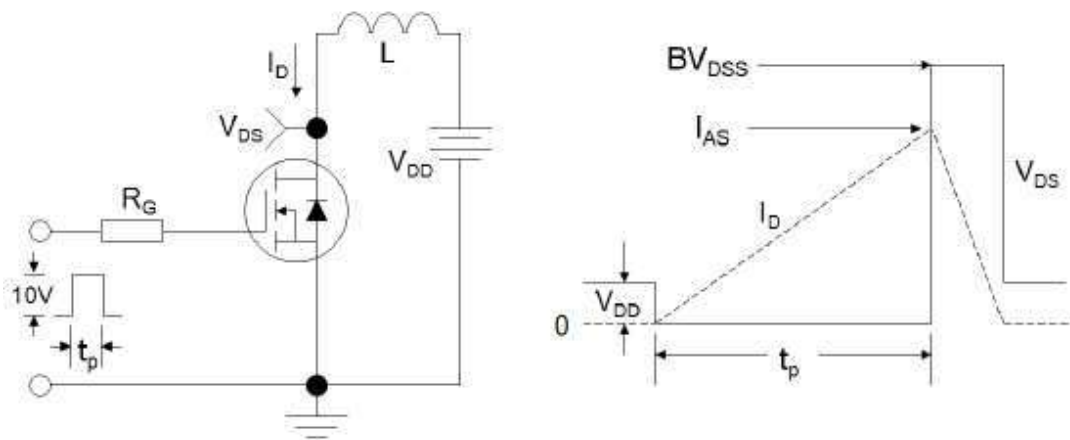
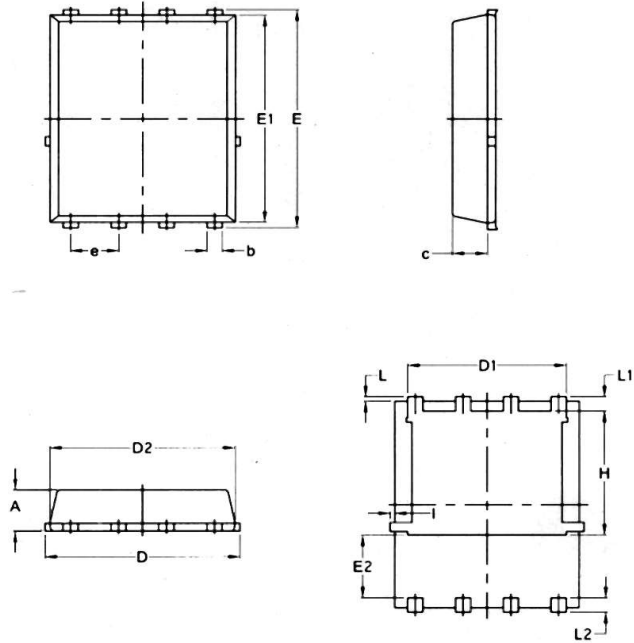

**Figure 3: Unclamped Inductive Switching Test Circuit & Waveforms**

**AP4085G**

**N-Channel Power MOSFET**

**Package Mechanical Data**



PDFN5X6-8L

SYMBOL	COMMON			
	MM		INCH	
	MIN.	MAX.	MIN.	MAX.
A	1.03	1.17	0.0406	0.0461
b	0.34	0.48	0.0134	0.0189
c	0.824	0.970	0.0324	0.0382
D	4.80	5.40	0.1890	0.2126
D1	4.11	4.31	0.1618	0.1697
D2	4.80	5.00	0.1890	0.1969
E	5.95	6.15	0.2343	0.2421
E1	5.65	5.85	0.2224	0.2303
E2	1.60	—	0.0630	—
e	1.27 BSC		0.05 BSC	
L	0.05	0.25	0.0020	0.0098
L1	0.38	0.50	0.0150	0.0197
L2	0.38	0.50	0.0150	0.0197
H	3.30	3.50	0.1299	0.1378
I	—	0.18	—	0.0070

**AP4085G****N-Channel Power MOSFET**

---

Information furnished in this document is believed to be accurate and reliable. However, Shenzhen All Power Semiconductor Co.,Ltd assumes no responsibility for the consequences of use without consideration for such information nor use beyond it.

Information mentioned in this document is subject to change without notice, apart from that when an agreement is signed, All Power complies with the agreement.

Products and information provided in this document have no infringement of patents. All Power assumes no responsibility for any infringement of other rights of third parties which may result from the use of such products and information.

This document supersedes and replaces all information previously supplied.

## X-ON Electronics

Largest Supplier of Electrical and Electronic Components

*Click to view similar products for [MOSFET](#) category:*

*Click to view products by [Quan Li](#) manufacturer:*

Other Similar products are found below :

[614233C](#) [648584F](#) [MCH3443-TL-E](#) [MCH6422-TL-E](#) [FDPF9N50NZ](#) [NTNS3A92PZT5G](#) [IRFD120](#) [IRFF430](#) [JANTX2N5237](#) [2N7000](#)  
[AOD464](#) [2SK2267\(Q\)](#) [2SK2545\(Q,T\)](#) [405094E](#) [423220D](#) [MIC4420CM-TR](#) [VN1206L](#) [614234A](#) [715780A](#) [SSM6J414TU,LF\(T](#) [751625C](#)  
[IPS70R2K0CEAKMA1](#) [BSF024N03LT3 G](#) [PSMN4R2-30MLD](#) [TK31J60W5,S1VQ\(O](#) [2SK2614\(TE16L1,Q\)](#) [DMN1017UCP3-7](#)  
[EFC2J004NUZTDG](#) [FCAB21350L1](#) [P85W28HP2F-7071](#) [DMN1053UCP4-7](#) [NTE2384](#) [NTE2969](#) [NTE6400A](#) [DMC2700UDMQ-7](#)  
[DMN2080UCB4-7](#) [DMN61D9UWQ-13](#) [US6M2GTR](#) [DMN31D5UDJ-7](#) [SSM6P54TU,LF](#) [DMP22D4UFO-7B](#) [IPS60R3K4CEAKMA1](#)  
[DMN1006UCA6-7](#) [DMN16M9UCA6-7](#) [STF5N65M6](#) [IRF40H233XTMA1](#) [IPSA70R950CEAKMA1](#) [IPSA70R2K0CEAKMA1](#) [STU5N65M6](#)  
[C3M0021120D](#)