

Antenna

YE0031AA Datasheet

Antenna Services

Version: 2.1

Date: 2021-07-25

Status: Released



Our aim is to provide customers with timely and comprehensive service. For any assistance, please contact our company headquarters:

Quectel Wireless Solutions Co., Ltd.

Building 5, Shanghai Business Park Phase III (Area B), No.1016 Tianlin Road, Minhang District, Shanghai 200233, China

Tel: +86 21 5108 6236

Email: info@quectel.com

Or our local office. For more information, please visit:

<http://www.quectel.com/support/sales.htm>.

For technical support, or to report documentation errors, please visit:

<http://www.quectel.com/support/technical.htm>

Or email to support@quectel.com.

General Notes

Quectel offers the information as a service to its customers. The information provided is based upon customers' requirements. Quectel makes every effort to ensure the quality of the information it makes available. Quectel does not make any warranty as to the information contained herein, and does not accept any liability for any injury, loss or damage of any kind incurred by use of or reliance upon the information. All information supplied herein is subject to change without prior notice.

Disclaimer

While Quectel has made efforts to ensure that the functions and features under development are free from errors, it is possible that these functions and features could contain errors, inaccuracies and omissions. Unless otherwise provided by valid agreement, Quectel makes no warranties of any kind, implied or express, with respect to the use of features and functions under development. To the maximum extent permitted by law, Quectel excludes all liability for any loss or damage suffered in connection with the use of the functions and features under development, regardless of whether such loss or damage may have been foreseeable.

Duty of Confidentiality

The Receiving Party shall keep confidential all documentation and information provided by Quectel, except when the specific permission has been granted by Quectel. The Receiving Party shall not access or use Quectel's documentation and information for any purpose except as expressly provided herein. Furthermore, the Receiving Party shall not disclose any of the Quectel's documentation and information to any third party without the prior written consent by Quectel. For any noncompliance to the above requirements, unauthorized use, or other illegal or malicious use of the documentation and information, Quectel will reserve the right to take legal action.

Copyright

The information contained here is proprietary technical information of Quectel. Transmitting, reproducing, disseminating and editing this document as well as using the content without permission are forbidden. Offenders will be held liable for payment of damages. All rights are reserved in the event of a patent grant or registration of a utility model or design.

Copyright © Quectel Wireless Solutions Co., Ltd. 2021. All rights reserved.

About the Document

Revision History

Version	Date	Author	Note
-	2020-12-21	Kenny YIN	Creation of the document
1.0	2020-12-21	Kenny YIN	First official release
1.1	2021-01-15	Kenny YIN	Updated the image in Chapter 2.
1.2	2021-01-27	Kenny YIN	Added IP rating description.
2.0	2021-04-27	Aria CHU	Updated all test data in the datasheets.
2.1	2021-07-25	Aria CHU	Updated the working temperature (Chapter 3).

Contents

About the Document.....	3
Contents.....	4
1 Product Description.....	5
2 Product Features	5
3 Product Specifications	6
4 Overall Performance.....	7
4.1. Test Environment	7
4.2. VSWR.....	8
4.3. Efficiency	9
4.4. Gain.....	10
4.5. Radiation Patterns.....	11
4.5.1. 2400 MHz	12
4.5.2. 2450 MHz	13
4.5.3. 2500 MHz	14
4.5.4. 5150 MHz	15
4.5.5. 5550 MHz	16
4.5.6. 5850 MHz	17
5 Product Size	18

1 Product Description

The antenna is designed for superior performance, and can be widely used for wireless applications.

We provide comprehensive antenna design support such as simulation, testing and manufacturing for custom antenna solutions to meet your specific application needs.

2 Product Features

- 2.4&5.8 GHz Wi-Fi dual-band
- High efficiency
- Excellent performance



3 Product Specifications

Passive Electrical Specifications

Frequency Range	2.4–2.5 GHz, 5.15–5.85 GHz
Input Impedence	50 Ω
VSWR	2.4 GHz: ≤ 3.0 , 5.8 GHz: ≤ 4.0
Gain	≤ 3.0 dBi
Polarization Type	Linear

Mechanical Specifications

Antenna Size	52 mm \times Φ 10 mm
Casing	ABS
Connector Type	SMA Male (center pin)
Working Temperature	-40 °C to +85 °C
Radome Color	Black
IP Rating	IP65

4 Overall Performance

4.1. Test Environment

- KEYSIGHT VNA Network Analyzer E5063A 100 kHz – 8.5 GHz
- RayZone®2800 Chamber 5G (FR1) SISO/MIMO, 400 MHz – 8.0 GHz



4.2. VSWR

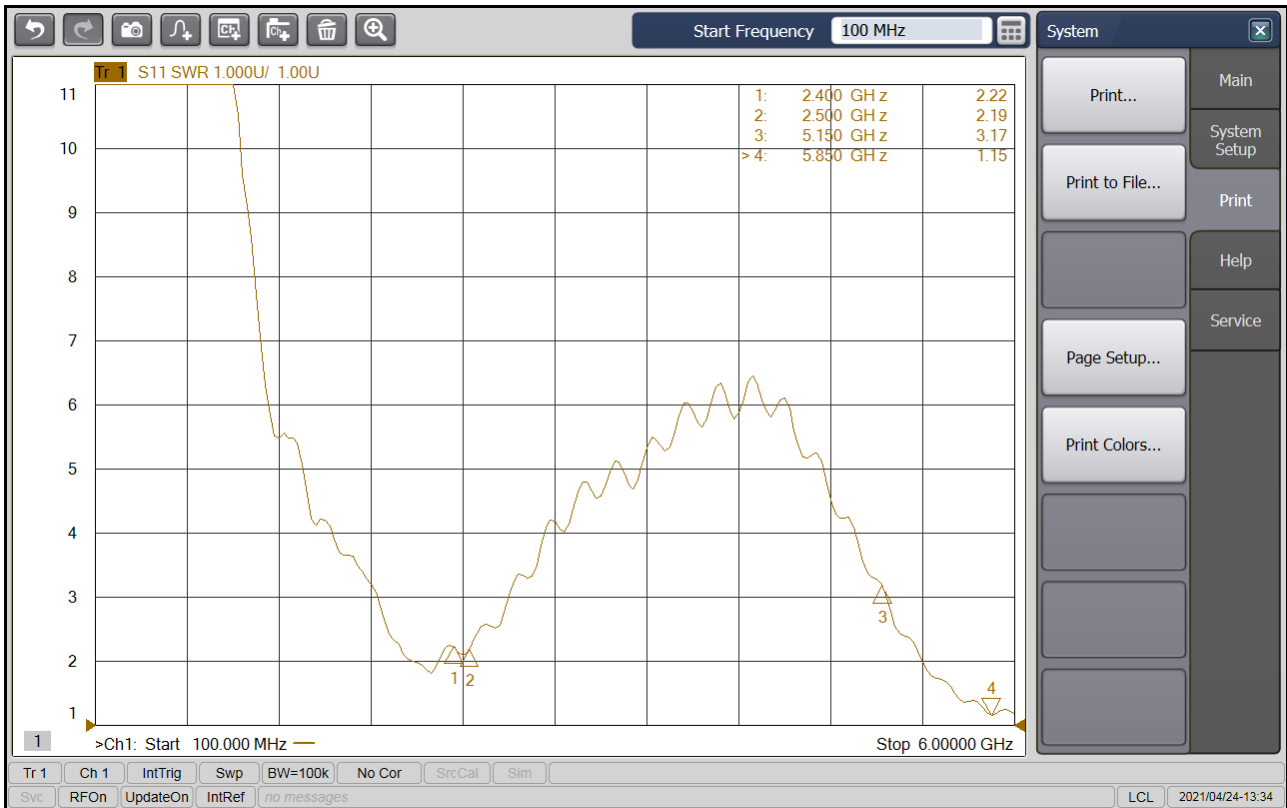

Frequency (MHz)	2400	2500	5150	5850
VSWR	2.22	2.19.	3.17	1.15

4.3. Efficiency

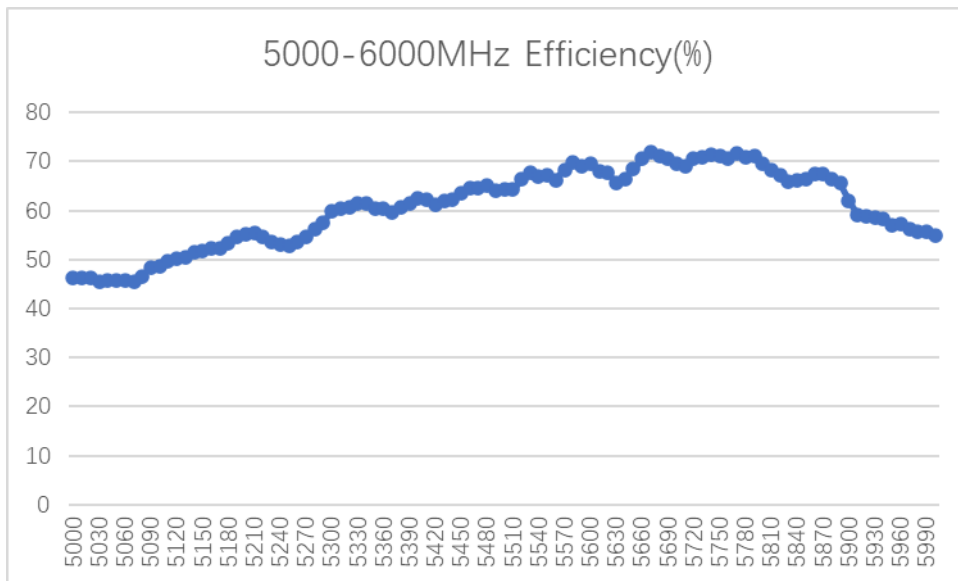
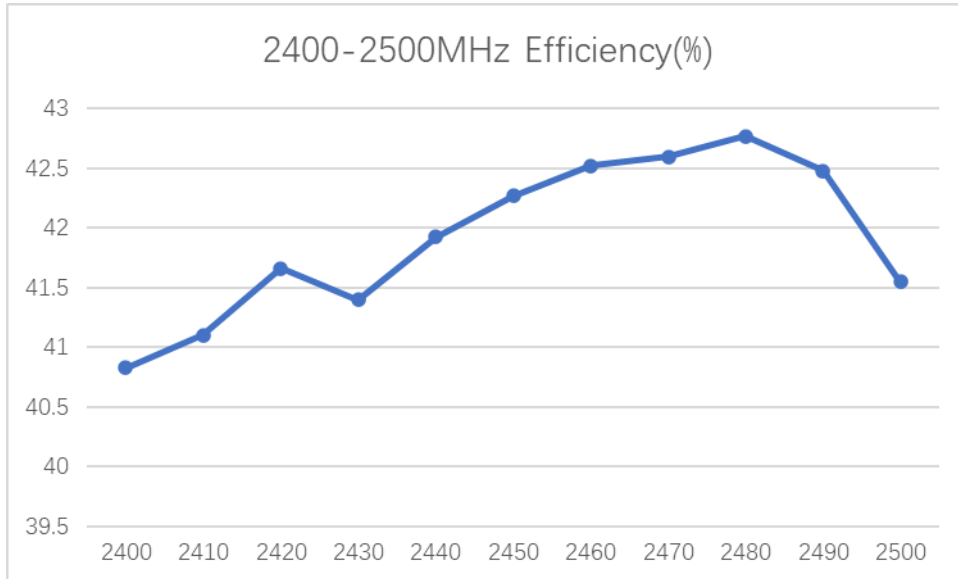

Frequency (MHz)	2400	2450	2500	5150	5550	5850
Efficiency (%)	40.83	42.27	41.55	51.76	67.34	66.37

4.4. Gain

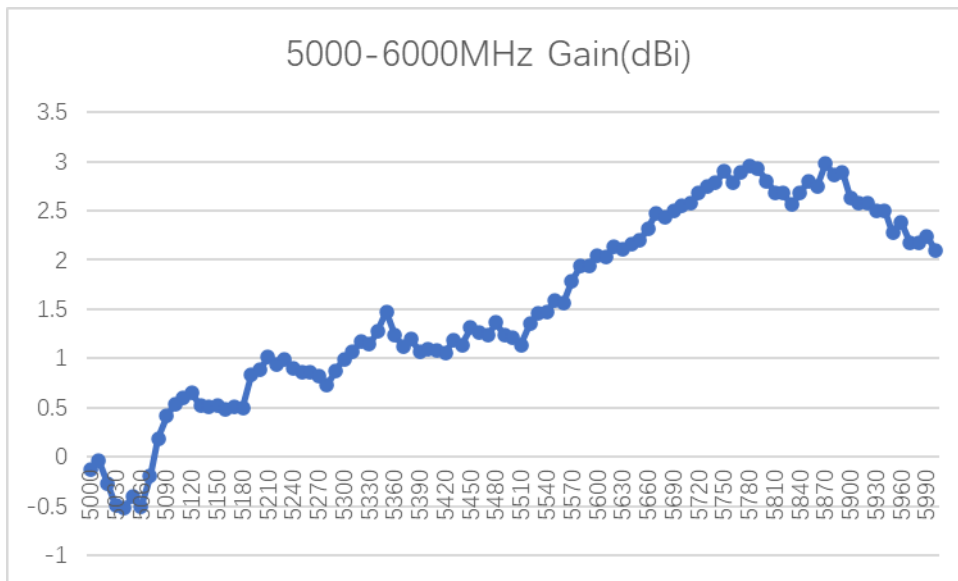
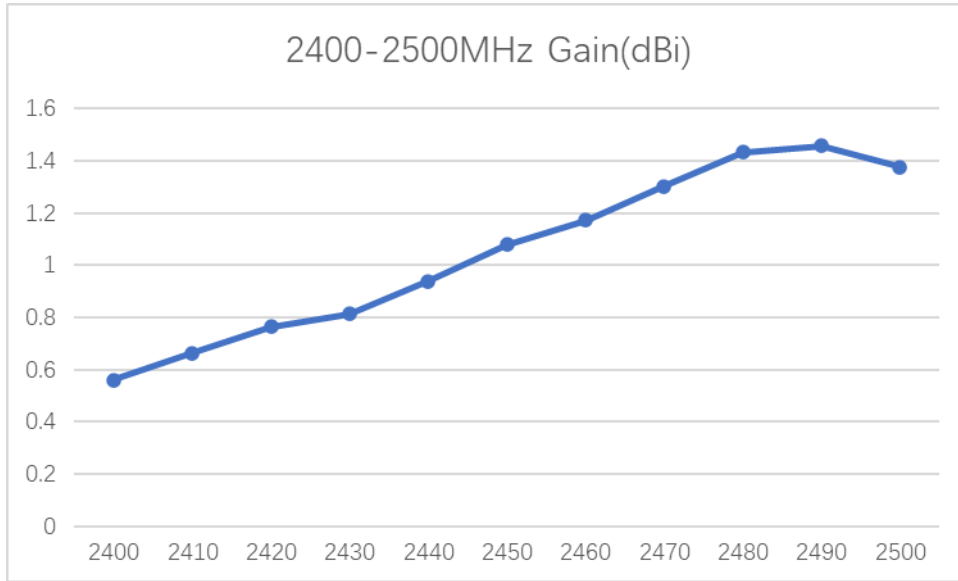

Frequency (MHz)	2400	2450	2500	5150	5550	5850
Gain (dBi)	0.56	1.08	1.38	0.52	1.59	2.80

4.5. Radiation Pattern

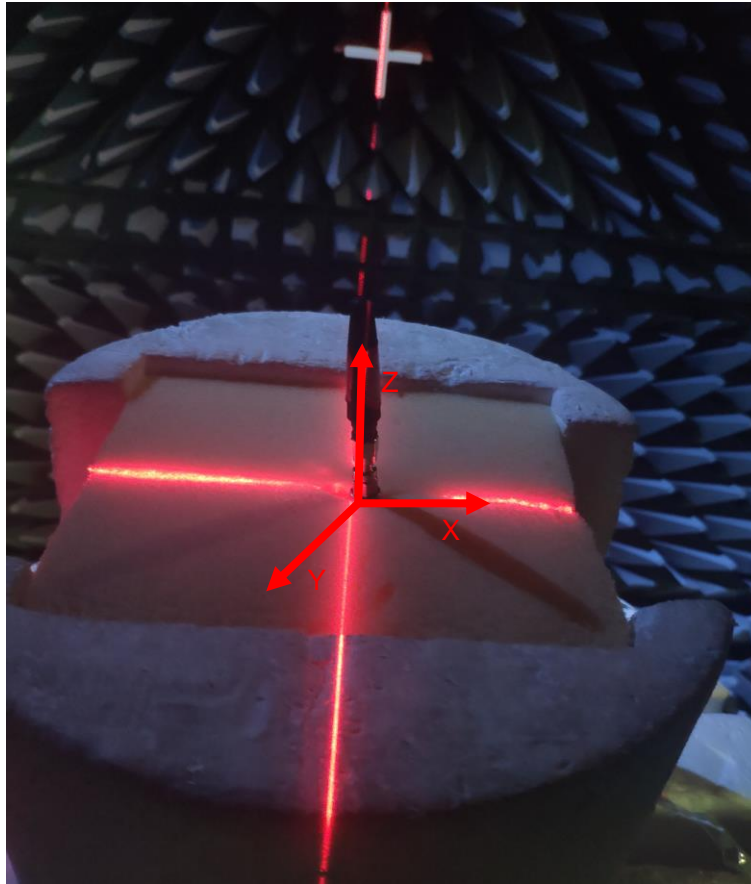

H plane: the tangent of XY
E1 plane: the tangent of XZ
E2 plane: the tangent of YZ

4.5.1. 2400 MHz

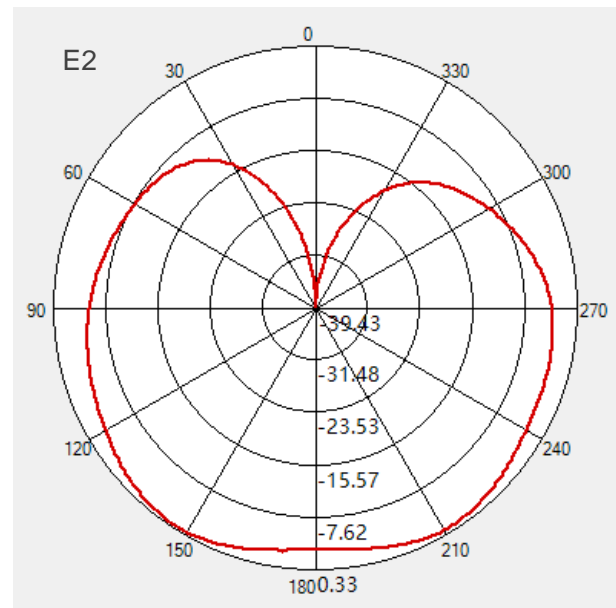
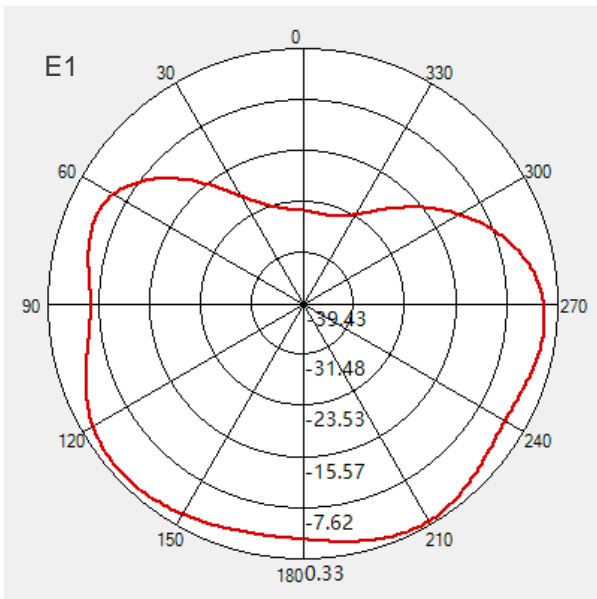
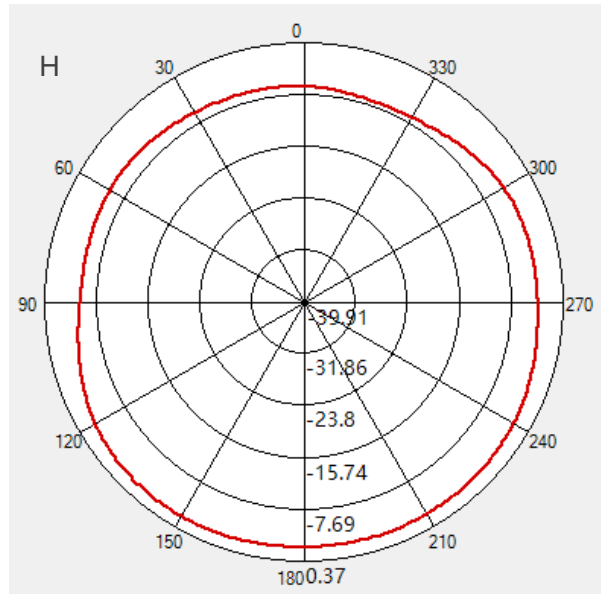
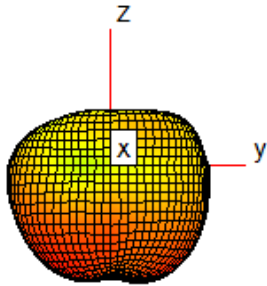

4.5.2. 2450 MHz

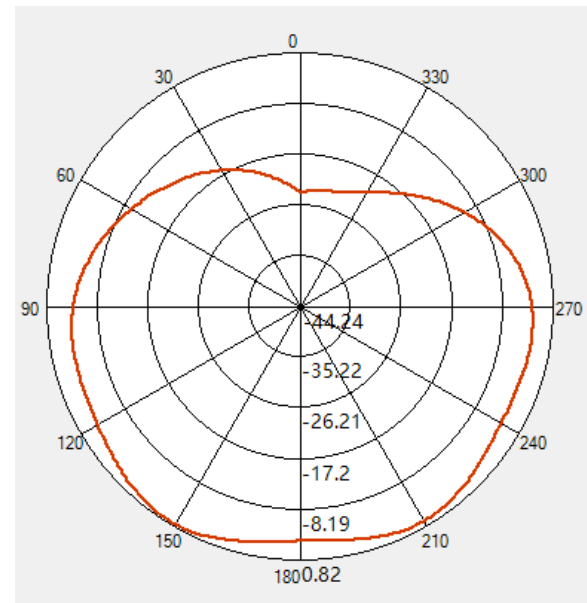
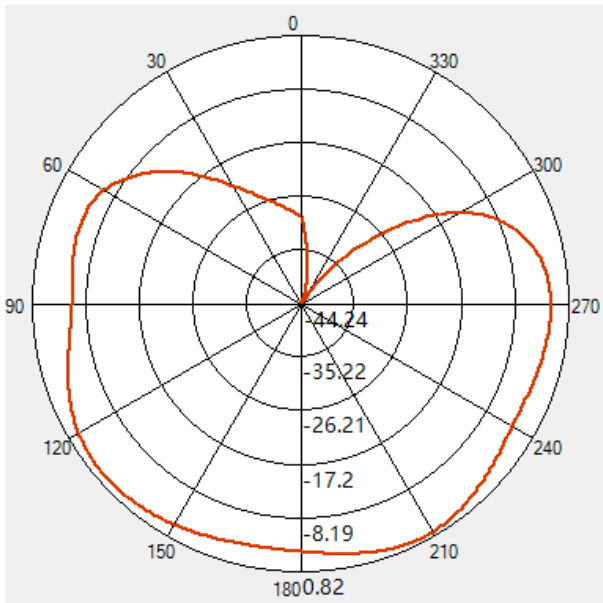
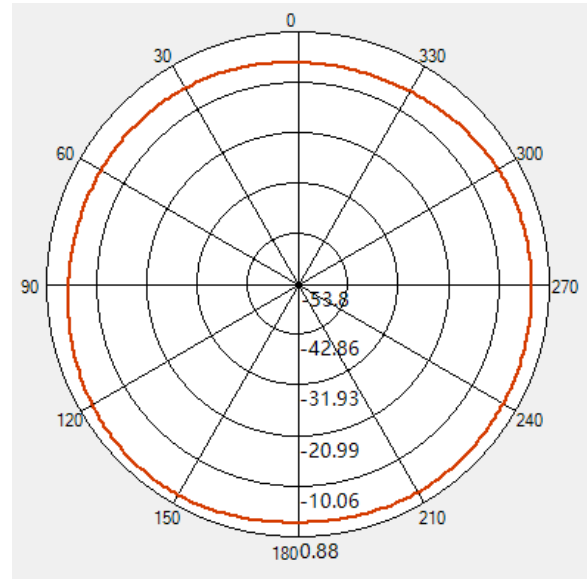
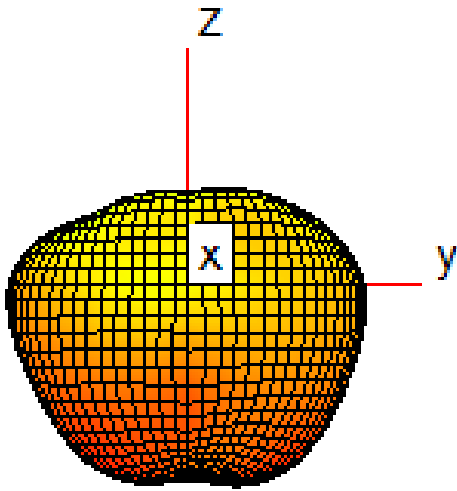

4.5.3. 2500 MHz

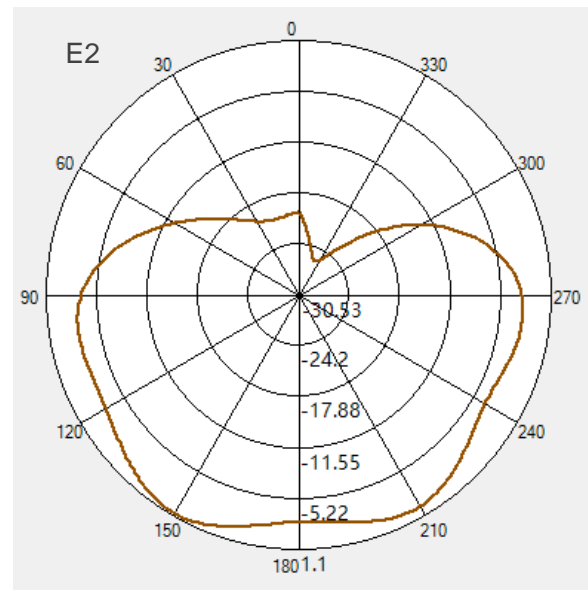
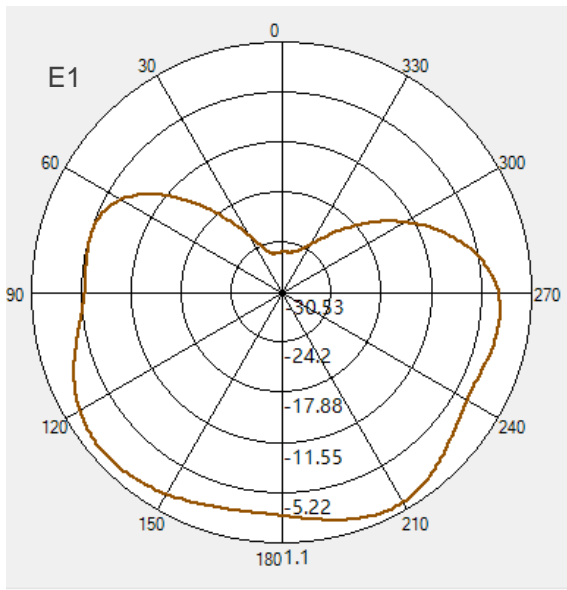
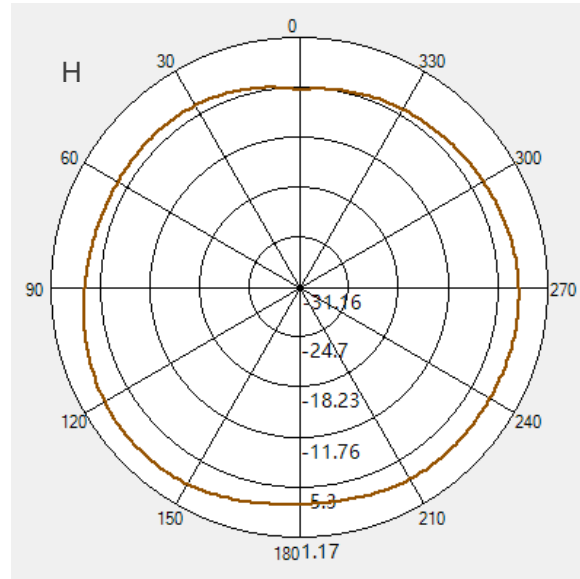
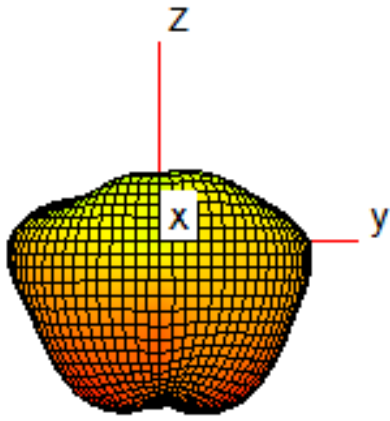

4.5.4. 5150 MHz

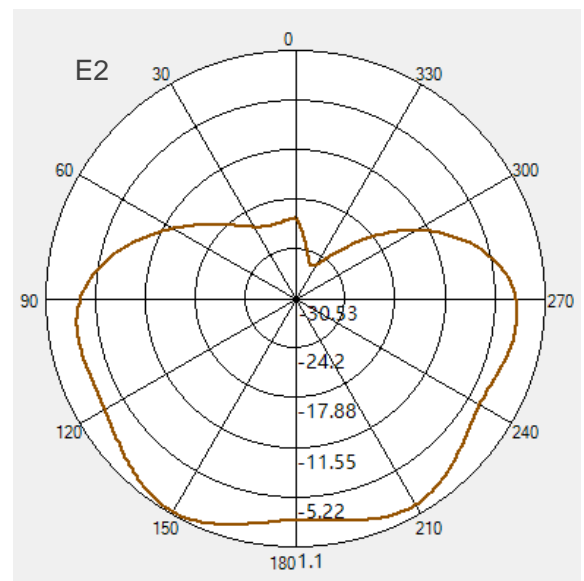
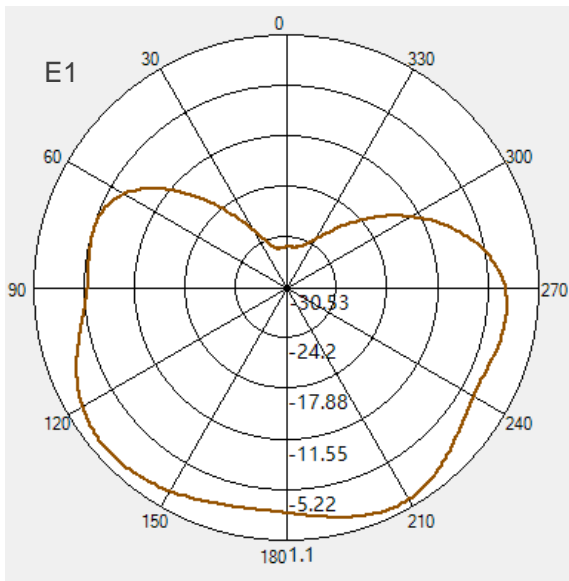
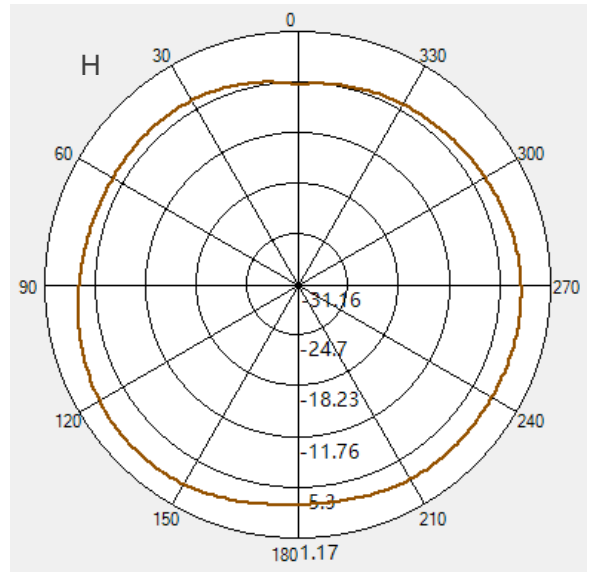
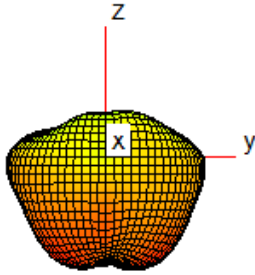

4.5.5. 5550 MHz

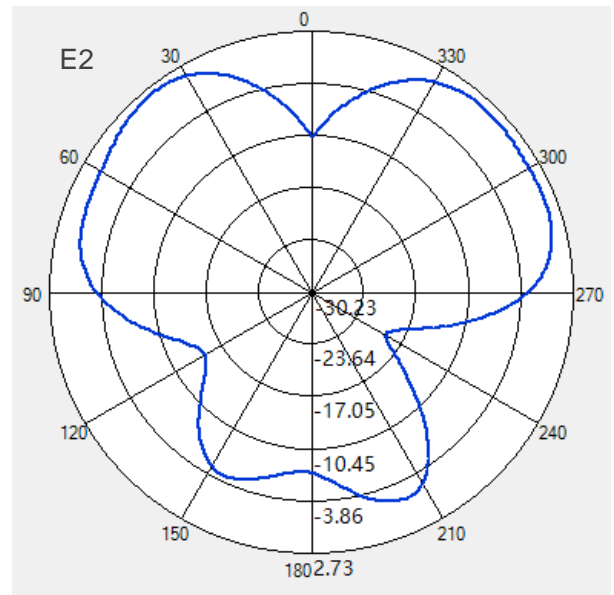
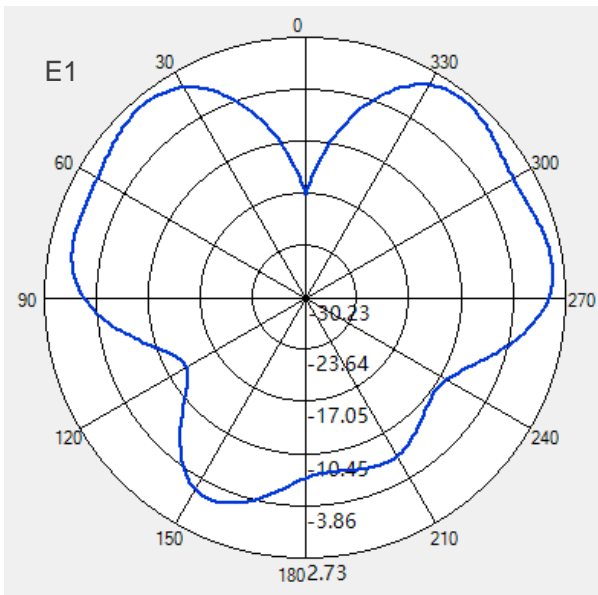
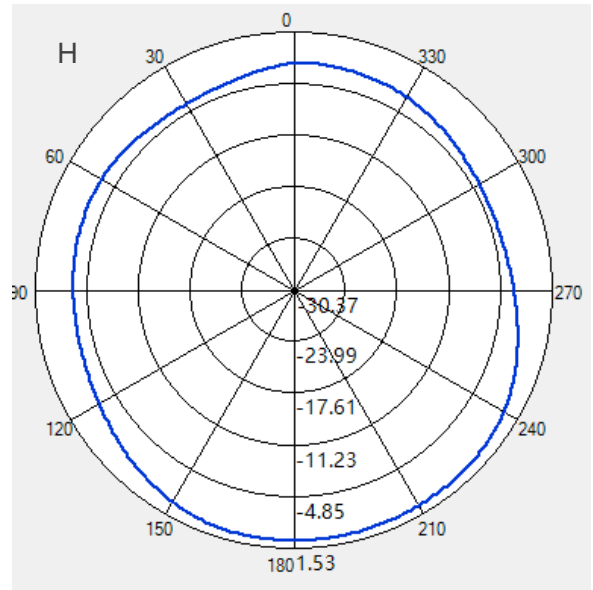
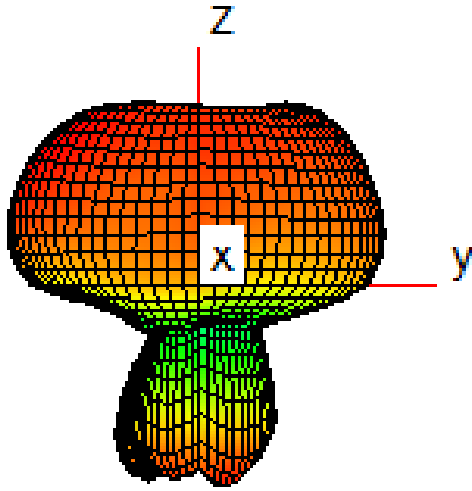

4.5.6. 5850 MHz

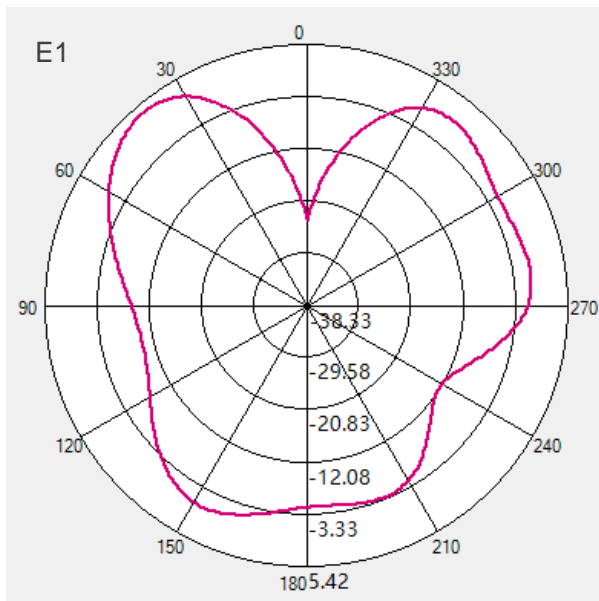
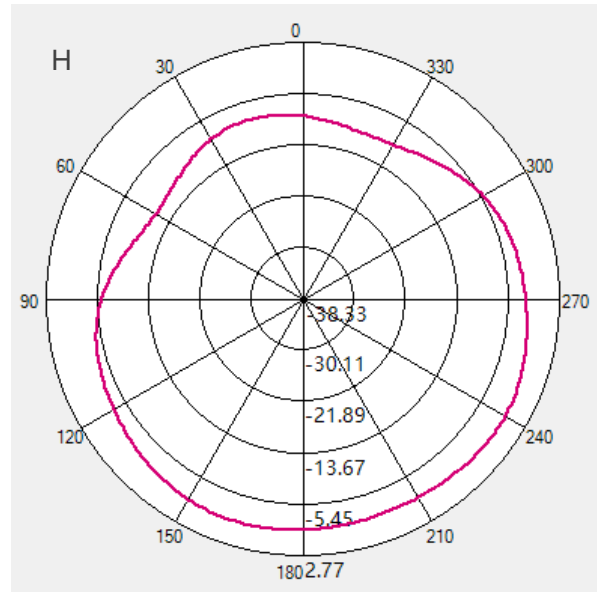
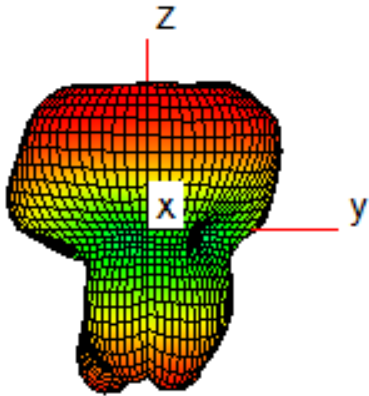

5 Product Size

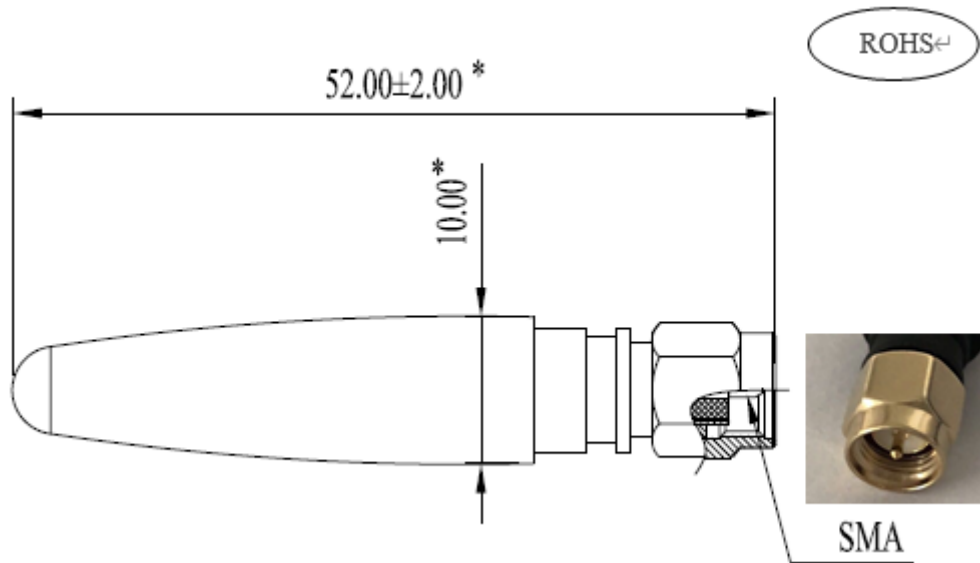

X-ON Electronics

Largest Supplier of Electrical and Electronic Components

Click to view similar products for [Antennas](#) category:

Click to view products by [Quectel Wireless](#) manufacturer:

Other Similar products are found below :

[930-033-R](#) [EXE902SM](#) [APAMPG-117](#) [66089-2406](#) [A09-F8NF-M](#) [A09-F5NF-M](#) [RGFRA1903041A1T](#) [108-00016-050](#) [W3525BW100](#)
[SIMNA-868](#) [SIMNA-915](#) [SIMNA-433](#) [W1049B090](#) [TRABT1560](#) [WTL2449CQ1-FRSMM](#) [CPL9C](#) [0600-00060](#) [Y4503](#) [PAL90209H-FNF](#)
[GD53-25](#) [C37](#) [MAF94051](#) [S9025PLSMF](#) [EXD420PL](#) [QWFTB120](#) [MAF94300](#) [FG4403](#) [MIKROE-2393](#) [GPSCPMM00](#) [ANTDOM-05-01-](#)
[WPM](#) [ANT-WP868SMA-Y](#) [EXW30BNX](#) [RAD-ISM-2459-ANT-FOOD-6-0-](#) [S4908WBFNM](#) [GD57-21](#) [108-20131-010](#) [108-00032-010](#)
[C27S](#) [CBNC58](#) [EXH160MXI](#) [EXH160SFK](#) [MD10-004](#) [EXC902SM](#) [CB27](#) [ABFT](#) [BB4502NR](#) [B4502N](#) [S4908WBFNF](#) [ANT-](#)
[GSMGPSPUKS](#) [60210](#)