

Crimp 01 : Soldered contact

COMPONENTS

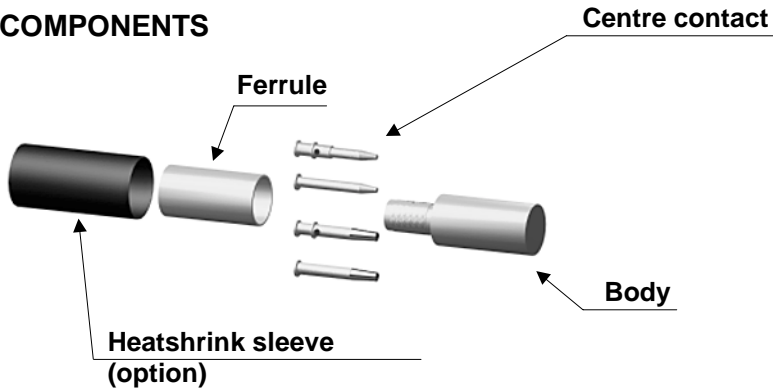

STRIPPING DIMENSIONS

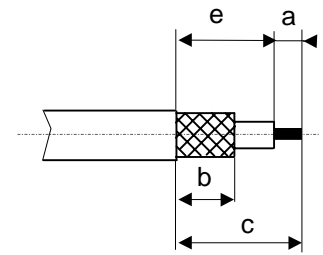

1

Slide the heatshrink sleeve onto the cable (Option).
Slide the ferrule onto the cable.
Strip the cable.

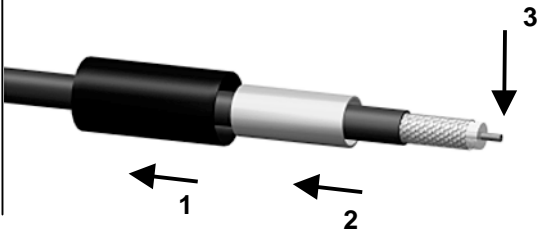

4

Slide the cable into the body until it bottoms against the insulator.

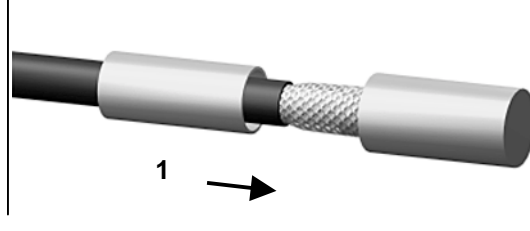

2

Slide the centre contact on until it bottoms against the cable dielectric.
Solder the centre contact.
Clean solder area.

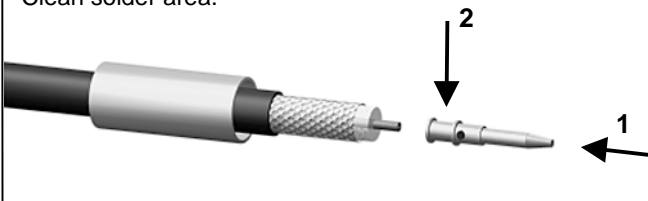

5

Slide the ferrule over the braid.
Crimp the ferrule with crimping tool (see connector TDS).

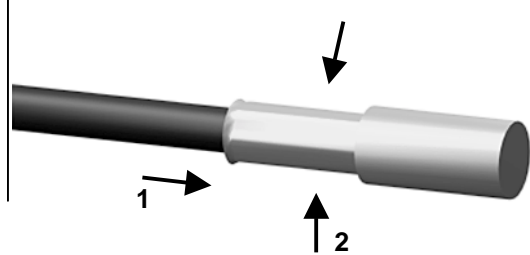

3

Fan the braid.

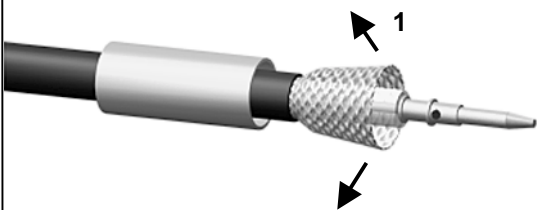

6

Cut the excess of braid if necessary.
Slide the sleeve over the ferrule and heatshrink it in place (Option).

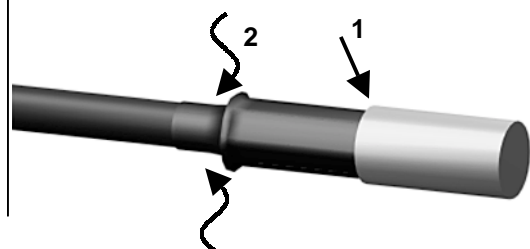

X-ON Electronics

Largest Supplier of Electrical and Electronic Components

Click to view similar products for [RF Connectors / Coaxial Connectors](#) category:

Click to view products by [Radiall](#) manufacturer:

Other Similar products are found below :

[8915-1511-000](#) [89674-0827](#) [6001-7071-019](#) [6002-7051-003](#) [6059674-1](#) [619550-1](#) [630059-000](#) [M39030/3-01N](#) [6769](#) [CX050L2AQ](#) [7002-1541-010](#) [7002-1542-011](#) [7002-1572-002](#) [7003-1542-011](#) [7004-1512-000](#) [7009-1511-004](#) [7010-1511-000](#) [7029-1511-060](#) [7101-1541-010](#) [7101-1571-002](#) [7145-1521-002](#) [7203-1571-003](#) [7209-1511-011](#) [7210-1511-015](#) [7210-1511-019](#) [73137-5015](#) [73216-2241](#) [73404-2300](#) [7405-1521-005](#) [7405-1521-802](#) [8527](#) [8547](#) [FS11V](#) [9049-9513-000](#) [9074-9513-000](#) [9101-9573-002](#) [910A205F](#) [9130-9573-002](#) [PL11SC-026](#) [PL375-33](#) [PL40-5](#) [PL74C-221](#) [PL75MC-217](#) [PL803-7](#) [980-8666-005](#) [1200690078](#) [1-201144-1](#) [R107003010W](#) [R110A172100](#) [R112186000](#)