

 MULTIPIN

EPX™ SERIES

Product Catalog

SIMPLIFICATION *is our INNOVATION*

Radiall is a community of dedicated individuals with a shared purpose: simplify life for all those who innovate. Our manufacturing expertise allows us to deliver lighter and smaller products that simplify implementation and drive performance. We recognize that simplification starts with us, but proves its true benefits when it reaches you.



Contents	
Introduction	1-3
Disconnect applications	1-4
Rack and panel applications	1-5
CHARACTERISTICS	
Disconnect connector technical characteristics	1-6
Rack & panel connector technical characteristics	1-7
Technical characteristics for inserts & contacts	1-8 to 1-9
INSERTS	
Insert selection table	1-10
How to order EPX® inserts	1-11
EPX® insert arrangements	1-12 to 1-14
CONTACTS	
Signal & power crimp contacts	1-15
Oversized and reduced crimp barrel contacts	1-16
Coaxial crimp contacts	1-17
Twinax and triax crimp contacts	1-18
Quadrax & BMA crimp contacts	1-19
LuxCis® fiber optic contacts	1-20
Signal PC tail contacts	1-21
Quadrax size 8 PC tail contacts	1-22
Filler plugs	1-23
Sealing plugs	1-23
DISCONNECT APPLICATION	
EPXA1 product overview	1-24
EPXB1 product overview	1-25
How to order EPXA1 and EPXB1 shell	1-26
How to order EPXA1 and EPXB1 assembly kit	1-27
Polarization code for EPXA1 and B1	1-28
Contact termination for EPXB1	1-29
EPXA1 shell dimensions	1-30
EPXA1 shell weights	1-30
EPXB1 shell dimensions	1-31
EPXB1 shell weights	1-31
EPXA1 & EPXB1 spare parts and accessories	1-32 to 1-33
EPXB2 connectors	1-34
EPXB2 product overview	1-35
EPXB2 range overview	1-36
EPXB2 latest innovations	1-37
How to order EPXB2 shell	1-38
How to order EPXB2 assembly kit	1-39
EPXB2 polarization code	1-40

Contents**DISCONNECT APPLICATION (CONTINUED)**

Contacts termination for receptacles	1-41
EPXB2 aluminium shell dimensions	1-42 to 1-43
EPXB2 composite shell dimensions	1-44
EPXB2 weights	1-45
EPXB2 accessories	1-46
EPXB2 spare parts	1-47
Disconnect tools	1-48

RACK & PANEL APPLICATION

EPX rack and panel for LRM - product overview	1-49
How to order EPXB1, B2, B3 & B4 shell for LRM	1-50
How to order EPXB1, B2, B3 & B4 assembly kit for LRM	1-51
EPXB shell mounting	1-52
EPXB polarization code	1-52
Contacts termination for EPXB1, EPXB2, EPXB3 and EPXB4 plugs	1-53
EPXB panel cut-out coding	1-54
EPXB1 shell dimensions and panel cut-outs	1-55
EPXB2 shell dimensions and panel cut-outs	1-56
EPXB3 shell dimensions and panel cut-outs	1-57
EPXB4 shell dimensions and panel cut-outs	1-58
Rack & panel accessories	1-59
Rack & panel tools	1-60
EPXB2 for LRU product overview	1-61
How to order EPXB2 shell for LRU	1-62
How to order EPXB2 assembly kit for LRU	1-63
EPX® galley product overview	1-64
How to order EPX® galley equipment connector	1-65
Dimensions and panel cut out	1-66
Multi-gang EPX® connectors	1-67

Introduction

Radiall is recognized in the Aerospace and Defense industries for offering one of the broadest innovative product portfolios for connector interconnect solutions. The benefit of our experience with ARINC connectors permits Radiall to provide customers with a strong and global solution.

The EPX® series offers a wide range of solutions based on two insert sizes with a large variety of shells and contacts. This product range provides an excellent trade-off between the number of available contacts and the space used. The EPX® series is completely modular and expandable.

EPX® connectors are standardized by the EN4644 European standard.

A **high density solution** compared to circular connectors:

- Slim shell design with high contact density
- Stackable shells do not require additional space for locking and unlocking the connectors

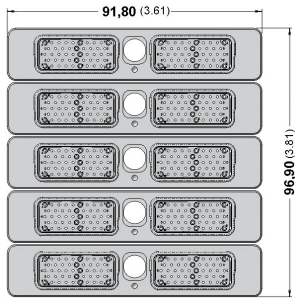

EPXB:

5 shells #2 with 2*48 Cts

--> Total Cts: 480

--> Total surface: $96.90 * 91.80 = 8895.42 \text{ mm}^2$

Gives $18.53 \text{ mm}^2/\text{contact}$

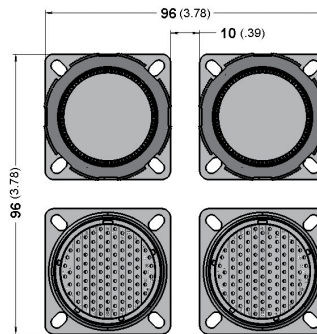

38999:

4 shells #23 with 100 Cts

--> Total Cts: 400

--> Total surface: $96.00 * 96.00 = 9216 \text{ mm}^2$

Gives $23.04 \text{ mm}^2/\text{contact}$

A **cost saving** and **user-friendly** solution:

- Inserts can be wired in the workshop and later installed in the shells
- A common panel cut-out simplifies the connector installation
- Inserts can be easily installed and removed from the shell
- Inserts and shells are keyed to prevent mis-mating
- Standard Mil spec tools for contact crimping and contact insertion/extraction
- Field replaceable sub-assemblies
- Vibration resistant self-locking threads

A **modular concept** with a large variety of options:

- Shell can accommodate a wide variety of inserts for signal, power, coax, data bus, fiber optic and high frequency BMA contacts
- Optional ground blocks (to meet the FAA HIRF requirements)
- Pin and socket inserts can be installed in either plug or receptacle shells (pin contacts are always fitted in the pin insert)

EPX® a **versatile solution** available in two different versions:

- Aluminium
- Composite

Disconnect Applications

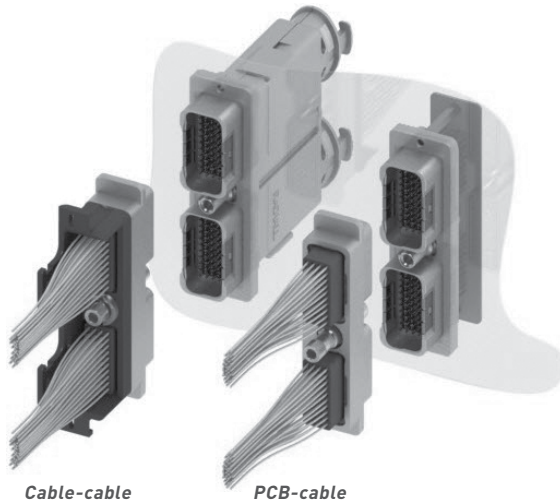

Specially designed for panel integration on EWIS applications, EPX® disconnect connectors cover cable-to-cable and PCB-to-cable links in major commercial and business jet aircrafts.

The connector can be easily identified by the locking device located directly on the connector (quarter turn device for A1 and B1 and central screws for EPXB2). This disconnect solution offers secure mating while answering OEM's most stringent requirements, and provides:

- 1- Modularity with three shell sizes: EPXA1, EPXB1 and EPXB2 - available as lightweight shells and compatible with several options such as ground block functionality. EPX® connectors also feature a large variety of inserts and a unique range of contacts covering any technology. EPX® connectors answer all connecting needs with the use of a limited number of components.
- 2- Space savings with the combination of a slim shell design and high density inserts. In addition, EPX® disconnect stackable shells do not require additional space to lock and unlock the connectors.
- 3- Time savings and cost effectiveness with modular parts that enable pre-wiring. Connectors are easy to assemble as the receptacle can be pre-installed. Inserts will be wired in the shop and plugged later, which saves integration time.



EPXA1



EPXB1



EPXB2

Rack and Panel Applications

In response to the need of system miniaturization and new equipment design, Radiall offers EPX® connector solutions for Line Replaceable Unit (LRU) and Line Replaceable Module (LRM). Discover more about these blind mate connectors:

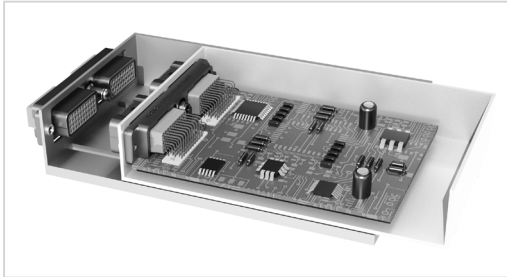

EPXB2 for LRU

Largely used in distributed architecture, small Line Replaceable Units in an aircraft need compact, lightweight and cost effective connectors.

EPXB2 connectors equipped with centering guide will combine high density, low efforts and lightweight features. Discover the whole range of EPXB inserts offering from signal to power or quadrax contacts (available in straight or right angle PC tails and crimp contacts).



EPX Rack & Panel for LRM

Today, equipment manufacturers look for more cost effective and easy to maintain solutions such as Line Replaceable Module (LRM). As a result, Radiall has developed a new generation of Rack & Panel connectors. EPX® Rack & Panel connectors feature a modular, lightweight and high density shell that can be used on standalone PCB architecture.

EPX® rack and panel connectors are the perfect solution when equipment needs to combine compactness, weight savings and very high density. They offer:

- A modular range: from size 1 to size 4 using the complete range of EPX® inserts.
- Low mating force contacts from EPX® range that can reach very high density.
- A comprehensive range of contacts: right angle or straight PC tails for signal, coax, quadrax, or power contacts.

Disconnect Connector Technical Characteristics

ELECTRICAL CHARACTERISTICS**EMI shielding effectiveness EN2591-213**

Frequency (MHz)	Leakage attenuation (dB)
100	65
200 & 300	63
400	62
500 & 600	60

- **Shell to shell conductivity** < 2.5 mΩ, operating voltage: 400 Vrms or 500 Vdc at sea level, according to EN2591-205
- **Voltage stability (ground block):** Maximum variation 4mV according to SAE AS 81714 (MIL-T-81714)
- **Lightning strike:**
 - 5kA - 1600V for EPX® connectors in aluminium version
 - 3kA - 1600V for EPX® connectors in composite version

MECHANICAL CHARACTERISTICS**Mating/unmating**

Shell type	Material	Mating/Unmating
EPXA1 / EPXB1 / EPXB2	Aluminium	100 cycles
EPXB1 / EPXB2	Composite	100 cycles

Vibration & shock

Shell type	Material	Vibration	Shock
		For 8 hrs on each of the 3 axis/ interruption <1μs EN2591-403 EIA 364-28	3 shocks on each axis EN2591-402 EIA 364-27
EPXA1 / EPXB1	Aluminium	Acceleration 27.8g (test condition 6 letter G)	Shock amplitude 50g /duration 11ms
EPXB1 / EPXB2	Composite		Shock amplitude 300g /duration 3ms
EPXB2	Aluminium		
Disconnect EPX® with Quadrax contacts	/	Acceleration 16.9g (test condition 5 letter E)	Shock amplitude 50g /duration 11ms

ENVIRONMENTAL CHARACTERISTICS

- **Temperature range:** according to EIA364-32 and EN2591-305
 - For EPXB2 aluminium, EPXB1 and EPXA1 shells: -65°C/+175°C [-85°F/+347°F]
 - For EPXB2 composite shell: -65°C/+125°C [-85°F/+257°F]
- **Temperature life:** 1000 hours at maximum temperature
- **Salt spray:** 96 hours (nickel-plated aluminium and composite) EN2591-307 EIA 364-26 test condition A
- **Humidity:** 10 days with temperature variation from -10°C to +65°C EIA 364-31 Method 4, test condition B
- **Altitude immersion:** EN2591-314 EIA 364-03:
 - EPXB insert: 3 cycles at 50,000 feet
 - EPXB Bulkhead class insert: 3 cycles at 55,000 feet
- **Air Leakage for EPXB2 Bulkhead receptacle:** Level from EN3645; test according EN2591-312 method B: $4.4 \times 10^{-3} \text{ cm}^3/\text{s}$ (= $16 \times 10^{-6} \text{ m}^3/\text{h}$)

Rack & Panel Connector Technical Characteristics

ELECTRICAL CHARACTERISTICS**EMI shielding effectiveness EN2591-213**

Frequency (MHz)	Leakage attenuation (dB)
100	65
200 & 300	63
400	62
500 & 600	60

- **Shell to shell conductivity:** < 2.5 m Ω, operating voltage: 400 Vrms or 500 Vdc at sea level, according to EN2591-205
- **Lightning strike:** 5kA - 1600V

MECHANICAL CHARACTERISTICS**Mating/unmating**

Shell type	Material	Mating/Unmating
EPXB1 / EPXB2 / EPXB3 / EPXB4	Aluminium	500 cycles

The minimum mating forces are described in the EN4644 standard and depend on the connector size and insert arrangement. Consult Radiall for more information.

Vibration & shock

Shell type	Material	Vibration	Shock
		For 8 hrs on each of the 3 axis/ interruption <1µs EN2591-403 EIA 364-28	3 shocks on each axis EN2591-402 EIA 364-27
EPXB1 / EPXB2 / EPXB3 / EPXB4	Aluminium	Acceleration 16.9g (test condition 5 letter E)	Shock amplitude 50g /duration 11ms

ENVIRONMENTAL CHARACTERISTICS

- **Temperature range:** -65°C/+125°C (-85°F/+257°F)
- **Temperature life:** 1000 hours at maximum temperature
- **Salt spray:** 96 hours EN2591-307 EIA 364-26 test condition A
- **Humidity:** 10 days with temperature variation from -10°C to +65°C EIA 364-31 Method 4, test condition B
- **Altitude immersion:** 3 cycles at 50,000 feet EN2591-314 EIA 364-03

Technical Characteristics for Inserts & Contacts**ELECTRICAL CHARACTERISTICS**

Electrical characteristics conform to SAE AS 39029 (MIL-C-39029 type A)

Contacts conform to EN3155-076 and EN3155-077

CONTACTS

Contact size	Wire size	Max current Amps
22	AWG22	5
	AWG24	3
	AWG26	2
20	AWG20	7.5
	AWG22	5
	AWG24	3
16	AWG16	13
	AWG18	10
	AWG20	7.5
12	AWG12	23
	AWG14	17
	AWG16	13
8	AWG8	46
5	AWG8	46 ¹
	AWG12	23
	AWG16	13

NOTES:

[1] Size contact 5 are not part of SAE AS 39029 (MIL-C-39029 type A)

GROUND BLOCK CONTACT (617221050)

	Contact with wire size	Max current Amps
Contact to contact	Contact + AWG20	7.5
Contact to mounting surface	Contact + AWG20	7.5

DIELECTRIC WITHSTANDING VOLTAGE EN2591-207 EIA 364-20 with leakage current < 1mΩ

Level	Environmental insert voltage (VRMS)	Non-environmental insert voltage (VRMS)
Sea level	1500	1500
50,000 feet	800	600
70,000 feet	800	300

INSULATION RESISTANCE EN2591-206 EIA 364-21

Temperature	Insulation resistance
Ambient temperature	> 5000 MΩ
175°C (+347°F)	> 200 MΩ

*Technical Characteristics for inserts and contacts***RETENTION CHARACTERISTICS**

Retention forces indicated below are valid for terminated contacts (as per EN2591-409 and EIA364-29)

Contact size	Retention force	Max displacement
Ground block	88N (20 lbs)	0.30mm (.012 in.)
22	53.4N (12 lbs)	0.38mm (.015 in.)
20	89N (20 lbs)	0.38mm (.015 in.)
16	111.2N (25 lbs)	0.38mm (.015 in.)
12	133.45N (30 lbs)	0.38mm (.015 in.)
8	133.45N (30 lbs)	0.38mm (.015 in.)
5	133.45N (30 lbs)	0.38mm (.015 in.)

- **Insert retention:** 400N (90 lbs) EN2591-410 EIA 364-35
- **Maximum insert displacement in the shell cavity:** 0.30mm (.012 in.)









Insert Selection Table

INSERTS

Insert name should be used when ordering EPX® insert

Insert code should be used when ordering EPX® assembly kit

Inserts available in Bulkhead class are identified with the following logo: 

Series	Insert name	Insert code	Contact Size & Type ⁽¹⁾										Total contacts	
			22*	20*	15 or 16*	16	16	12*	8	8	5	5		
			Signal	Power	Power or coax	LuxCis® fiber optic	Power in fiber optic cavity	Power or coax	Power	Quadrax or twinax	Coax or triax	Power		
EPXA	00	0												0
	1C1	A										1		1
	1P1	B											1	1
	04	C			2				2					4
	09	D		3	6									9
	14	E		14										14
	14M	F	8	3	3									14
	17	G	12	5										17
	20	H	20											20
EPXB	00	0												0
	C3	A										3		3
	 P3	B											3	3
	3Q3	C									3			3
	 06	D							6					6
	10Q2	E		8							2			10
	12F6	F				6	6							12
	 F12C	G				12								12
	13C1	H		6	4				2			1		13
	13P1	J		6	4				2				1	13
	 14	K			14									14
	17	L		14					3					17
	20C1	M		19								1		20
	20P1	N		19									1	20
	22	P		16	6									22
	22V	Q		16	6									22
	25P1	R	24							1				25
	 25Q1	S	24								1			25
	 28	T	22		6									28
	 30	U		30										30
34	W	18	16										34	
40	X	40											40	
 48	Y	48											48	

NOTE: (1) Only contacts marked with an asterisk (*) are included with EPX® insert kit. All other contacts must be ordered separately (coax, twinax, quadrax and fiber optic contacts)

How to order EPX® inserts

Only crimp contacts can be delivered with insert

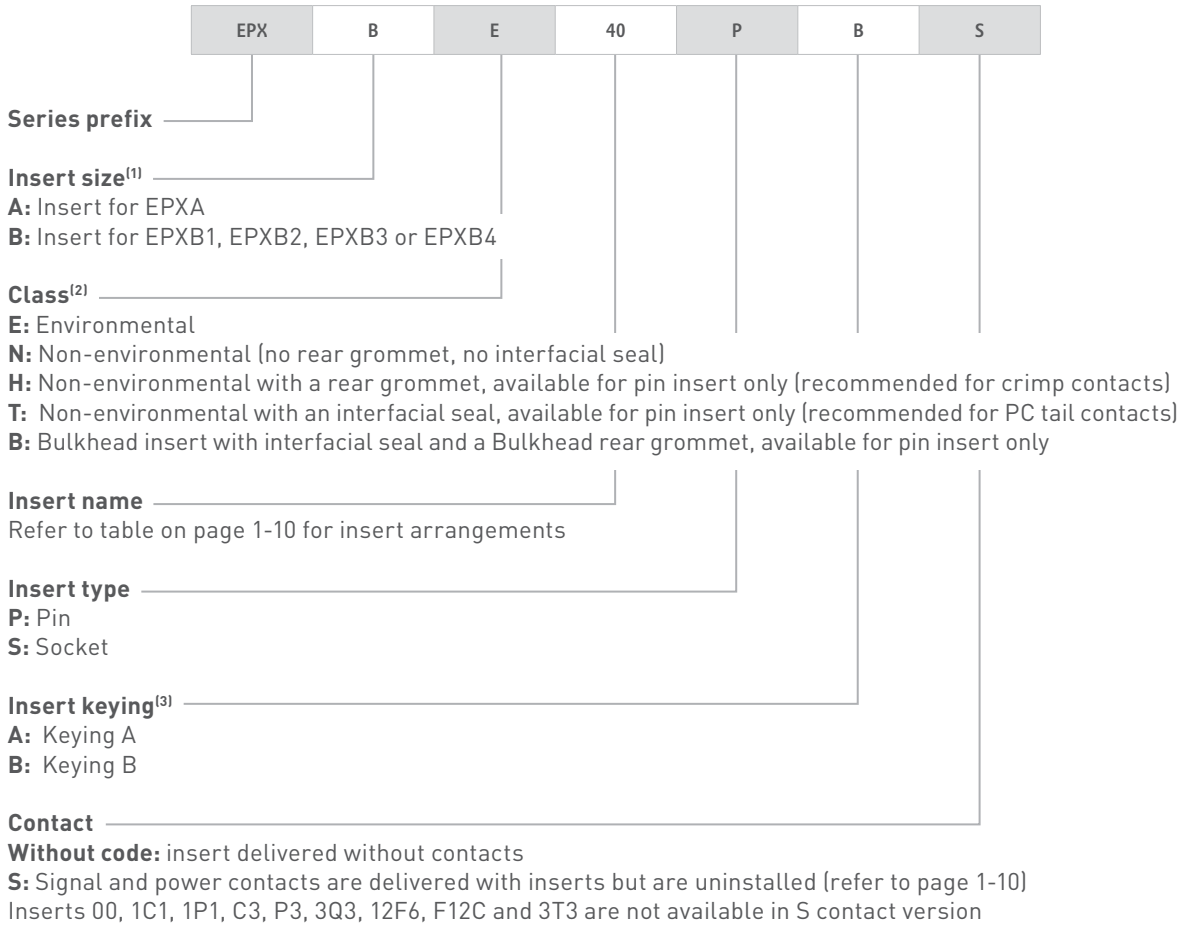

ENVIRONMENTAL INSERT

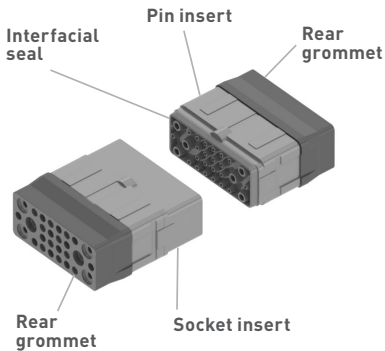

BULKHEAD INSERT

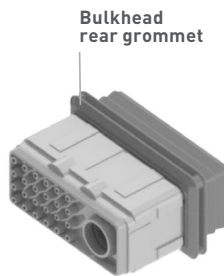

INSERT KEYING

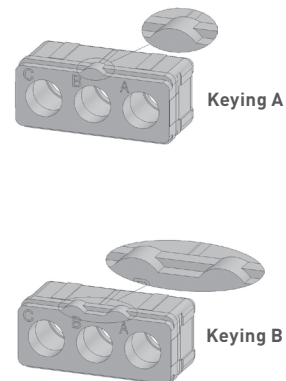

NOTES:

- (1) Inserts are designed for rear release & rear removable contacts
- (2) Pin and socket inserts can be installed in either plug or receptacle shell
F6, F12C and 12F6 are only available in E class. Insert 00 is only available in N class
- (3) For EPXA1, EPXB1, EPXB3 and EPXB4 shells, use only insert keyed A
For EPXB2 shells, use one insert keyed A and one insert keyed B

EPXA Insert Arrangements

Insert name 00 Insert code 0 Blank insert ⁽¹⁾	Insert name 1C1 Insert code A 1 x size 5 coax contacts	Insert name 1P1 Insert code B 1 x size 5 power contacts	Insert name 04 Insert code C 2 x size 15 or 16 contacts 2 x size 12 contacts
Insert name 09 Insert code D 3 x size 20 contacts 6 x size 15 or 16 contacts	Insert name 14 Insert code E 14 x size 20 contacts	Insert name 14M Insert code F 8 x size 22 contacts 3 x size 20 contacts 3 x size 15 or 16 contacts	Insert name 17 Insert code G 12 x size 22 contacts 5 x size 20 contacts
Insert name 20 Insert code H 20 x size 22 contacts			

WEIGHTS

Average weight per class and type for EPXA inserts without contacts.

Insert Class	Insert type	
	Pin	Socket
E	4.10 g (0.14 oz)	5.30 g (0.19 oz)
N	2.60 g (0.09 oz)	4.00 g (0.14 oz)
H	3.90 g (0.14 oz)	N/A
T	2.80 g (0.10 oz)	N/A

NOTE:

(1) P/N for blank insert is EPXAN00

INSERTS

CONTACTS

DISCONNECT APPLICATION

RACK & PANEL APPLICATION

EPXB Insert Arrangements

Full size inserts arrangements are compliant with EN4644.

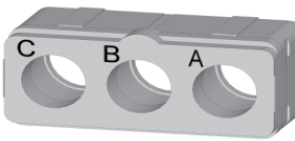
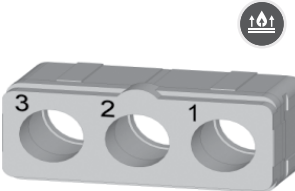
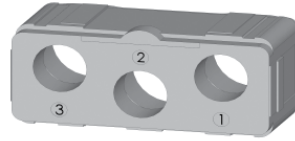
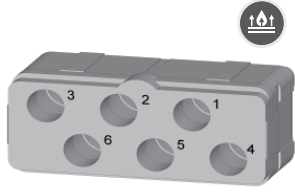
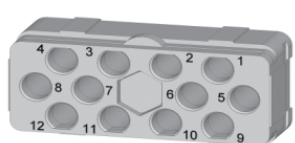
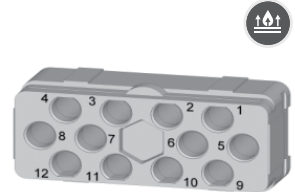
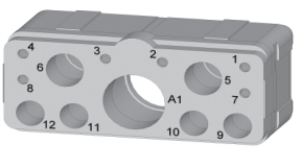
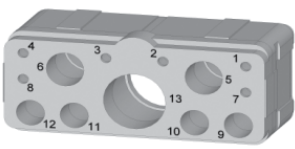
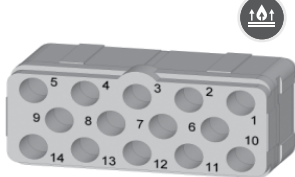
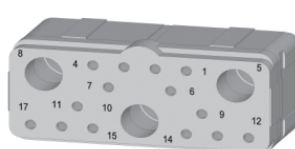
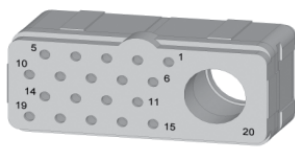
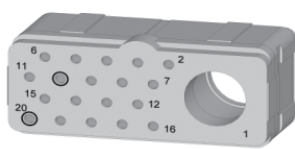
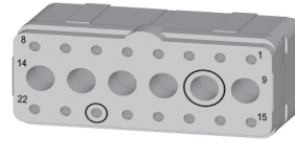
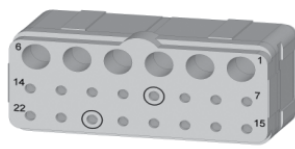
			
Insert name 00 Insert code 0 Blank insert ⁽¹⁾	Insert name C3 Insert code A 3 x size 5 coax contacts	Insert name P3 Insert code B 3 x size 5 power contacts	Insert name 3Q3 Insert code C 3 x size 8 quadrax contacts
			
Insert name 06 Insert code D 6 x size 12 medium power contacts	Insert name 10Q2 Insert code E 8 x size 20 contacts 2 x size 8 quadrax contacts	Insert name 12F6 Insert code F 6 x size 16 Optical LuxCis® termini 6 x size 16 special electrical contacts	Insert name F12C Insert code G 12 x size 16 Optical LuxCis® termini
			
Insert name 13C1 Insert code H 6 x size 20 contacts 4 x size 15 or 16 contacts 2 x size 12 contacts 1 x size 5 coax contact	Insert name 13P1 Insert code J 6 x size 20 contacts 4 x size 15 or 16 contacts 2 x size 12 contacts 1 x size 5 power contact	Insert name 14 Insert code K 14 x size 15 or 16 contacts	Insert name 17 Insert code L 14 x size 20 contacts 3 x size 12 contacts
			
Insert name 20C1 Insert code M 19 x size 20 contacts 1 x size 5 coax contact	Insert name 20P1 Insert code N 19 x size 20 contacts 1 x size 5 power contact	Insert name 22 Insert code P 16 x size 20 contacts 6 x size 15 or 16 contacts	Insert name 22V Insert code Q 16 x size 20 contacts 6 x size 16 contacts

NOTE:
(1) P/N for blank insert is EPXBN00

EPXB Insert Arrangements

Full size inserts arrangements are compliant with EN4644.

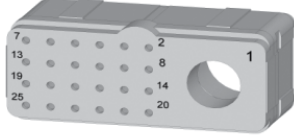
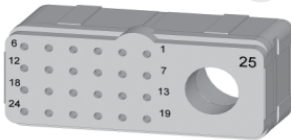
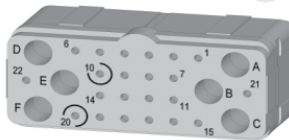
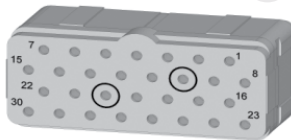
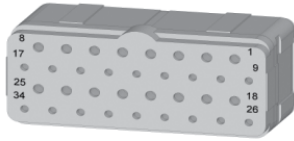
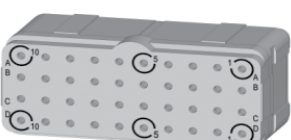
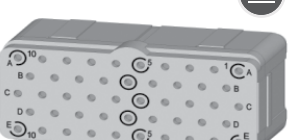
			
<p>Insert name 25P1 Insert code R 24 x size 22 contacts 1 x size 8 power contact</p>	<p>Insert name 25Q1 Insert code S 24 x size 22 contacts 1 x size 8 quadrax contact</p>	<p>Insert name 28 Insert code T 22 x size 22 contacts 6 x size 15 or 16 contacts</p>	<p>Insert name 30 Insert code U 30 x size 20 contacts</p>
			
<p>Insert name 34 Insert code W 18 x size 22 contacts 16 x size 20 contacts</p>	<p>Insert name 40 Insert code X 40 x size 22 contacts</p>	<p>Insert name 48 Insert code Y 48 x size 22 contacts</p>	

WEIGHTS

Average weight per class and type for EPXB inserts without contacts.

Insert Class	Insert type	
	Pin	Socket
E	7.90 g (0.28 oz)	10.00 g (0.35 oz)
N	5.20 g (0.18 oz)	7.60 g (0.27 oz)
H	7.70 g (0.27 oz)	N/A
T	5.50 g (0.19 oz)	N/A
B	8.50 g (0.30 oz)	N/A

Signal & Power Crimp Contacts

CONTACTS

EPX® series offers a wide range of contacts compliant with EN3155 and SAE AS 39029. The available contacts cover aerospace applications for terminating to both cables and printed circuit boards.

- Signal and power contacts
- High frequency with coax, twinax and triax contacts
- Ethernet links with Quadrax contacts
- Optical links with LuxCis® contacts

Discover our brand new range of signal & power contacts with selective gold plating.

Features and benefits:

- Significant reduction of cost of ownership
- Reduced dependence on gold rate fluctuation
- No change in the contact crimping or soldering process

Specifications:

- Same contact design as full plated version
- Contact interface gold plated with 1.27µm
- For crimp version, no changes are required for the crimping process
- For PC tail version, the use of selective plated contacts has no impact on PCB design
- Product qualification is available upon request

CONTACT SELECTION TABLE

Contact size	Wire size	Type	Part number full plated	Part number selectively plated	Crimping tool	Positioner	Selector	Ins / ext tool	Material of tool	
22	22	Pin	617200	617200100	282281 M22520/2-01	282970 M22520/2-23	4	282522 (M81969/14-01)	Plastic	
	24		617300	617300100			3			
20	20	Pin	617221	617221100	282281 M22520/2-01	282971 M22520/2-08	7	282522001 (M81969/39-01)	Plastic	
	22		617320	617320100			6			
16	16	Pin	617240	617240100	282291 M22520/1-01	282972 M22520/1-02	6	282515 (M81969/14-03)	Plastic	
			18	617340			617340100			5
	for ground block	20	Pin	617221050	N/A	282281 M22520/2-01	282581015 M22520/2-11	7	282886 M81969/1-02	Metal
				Socket	N/A			N/A		
for optical/electrical cavity	16	Pin	617235003 ⁽¹⁾	N/A	282291 M22520/1-01	282581013	6	282515 (M81969/14-03)	Plastic	
			18	617235003 ⁽¹⁾			N/A			5
12	12	Pin	617250	617250100	282291 M22520/1-01	282972 M22520/1-02	8	282549004 (M81969/14-04)	Plastic	
	14	Socket	617350	617350100			7			
	16						6			
8	8	Pin	617291002 ^(2&3)	N/A	R282600000 M22520/ 23-01 + Die set R282650000 M22520/23-02	282588	N/A	282549001	Metal	
		Socket	617391002 ^(2&3)	N/A						
5	8	Pin	617280 ^(2&4)	N/A	R282600000 M22520/ 23-01 + Die set R282650000 M22520/23-02	282557020	N/A	282946 (M81969/28-01)	Metal	
		Socket	617390 ^(2&4)	N/A						282557021
	12	Pin	617260001 ^(2&4)	N/A	282613	282586003	6			
			16	617370001 ^(2&4)		N/A	282586005			4

NOTES:

(1) Electrical contacts for optical inserts are always pin contacts (hermaphrodite)

(2) In order to make these contacts environmental, it is necessary to add a sealing boot. Please contact us for additional information

(3) These power contacts can be used in power inserts only (25P1)

(4) These power contacts can be used in power inserts only (P3, 13P1 and 20P1)

Oversized & Reduced Crimp Barrel Contacts

Contact size	Wire size	Type	Part number fully plated	Crimping tool	Positioner	Selector	Ins / ext tool	Material of tool	
22	reduced crimp barrel	28	Pin	617201	282281 M22520/2-01	282970 M22520/2-23	5	282522 (M81969/14-01)	Plastic
		30	Socket	617301			4		
	oversize crimp barrel	20	Pin	617200200	282281 M22520/2-01	282970 M22520/2-23	5		
		22	Socket	617300200			4		
		24					3		
		24					4		
20	reduced crimp barrel	22	Pin	617224001	282281 M22520/2-01	282971 M22520/2-08	4	282522001 (M81969/39-01)	Plastic
		24	Socket	617324001			3		
		26					3		
		oversize crimp barrel	18	Pin			617221200		
	20		Socket	617320200	5				
	22				4				
	22		4						
	16	reduced crimp barrel	20	Pin	617241	282291 M22520/1-01	282972 M22520/1-02		
22			Socket	617341	5				
24					4				
reduced crimp barrel for optical electrical cavity		20	Pin	617235002 ⁽¹⁾	282291 M22520/1-01	282581013	5		
		22	4						
		24		4					
oversize crimp barrel		14	Pin	617240200	282291 M22520/1-01	282972 M22520/1-02	6		
		16	Socket	617340200			5		
		18					5		

NOTES:

(1) Electrical contacts for optical inserts are always pin contacts (hermaphrodite)

Coaxial Crimp Contacts

Contact size	Cable type	Type	Environmental part number	Non-environmental part number	Ins/ext tool	Material of tool
15-16	RG188 FILECAF1709/6 F1709/8 RG174-RG179-RG316 ASNE0639XY 75 Ohms	Pin	617130		282512 (M81969/14-03)	Metal
		Socket	617030			
	RG178	Pin	617131			
		Socket	617031			
	GORE/AXON P812817 FILECA F1703-134 FILOTEX SP132868	Pin	617132			
		Socket	617032			
	RG178 DT	Pin	617133			
		Socket	617033			
	UT .047	Pin	617135			
		Socket	617035			
12	UT.085-RG405	Pin	617160		282549004 (M81969/14-04)	Plastic
		Socket	617060			
5	RG58-RG141	Pin	617101001	617101	282946 (M81969/28-01)	Metal
		Socket	617001001	617001		
	RG142 - RG400	Pin	617102001	617102		
		Socket	617002001	617002		
	RG174-RG316-RG188- RG178DS NEXAN 10036442 75 Ohms	Pin	617103001	617103		
		Socket	617003001	617003		
	RG178-RG196	Pin	617104001	617104		
		Socket	617004001	617004		
	RG180 PAN6422XZ ANSE063WGH 96 Ohms	Pin	617105001	617105		
		Socket	617005001	617005		

EPX® SERIES

INSERTS

CONTACTS

DISCONNECT APPLICATION

RACK & PANEL APPLICATION

Twinax & Triax Crimp Contacts

Contact size	Cable type	Type	Environmental part number	Non-environmental part number	Ins/ext tool	Material of tool
12 Triax	ECS0700	Pin	617190010		282549004 (M81969/14-04)	Plastic
		Socket	617090010			
	M17/176-00002	Pin	617190012			
		Socket	617090012			
8 Triax	TENSOLITE 24463/9PO25X-2 100 Ohms	Pin	617165021	617165020	282549001	Metal
		Socket	617065021	617065020		
	WHITMOR W2675-1575	Pin	617165	617165001		
		Socket	617065	617065001		
8 Twinax	ABS0386WF24 & TYCO 1726A1424A	Pin	617165011	620165010	282549001	Metal
		Socket	617065011	620065010		
5 Triax	PAN6421ZA002 77 Ohms M17/176-00002 EN3375-003 Raychem 106113 77 Ohms	Pin	617150001	617150	282946 (M81969/28-01)	Metal
		Socket	617050001	617050		
	TENSOLITE 24473/03159X 124 Ohms	Pin	617152001	617152		
		Socket	617052001	617052		

Quadrax & BMA Crimp Contacts

QUADRAX CONTACTS



The Quadrax contact offer is compliant to Arinc 600 and EN3155-072 and EN3155-073 standards.

Environmental Quadrax

Contact size	Cable type	Type	Environmental part number	Extraction tool in metal
8	Ethernet cable ABS0972 & ABS1503	Pin	617175011	282549001
		Socket	617075011	
	TENSOLITE NF24Q100	Pin	617175051	
		Socket	617075051	
	TENSOLITE NF26Q100/ JSF Y18	Pin	617175053	
		Socket	617075053	
	TENSOLITE NF22Q100	Pin	617175041	
		Socket	617075041	

Non-environmental Quadrax

Contact size	Cable type	Type	Non-environmental part number	Compatible sealing boot part number	Extraction tool in metal
8	Ethernet cable ABS0972 & ABS1503	Pin	617175012	617939003	282549001
		Socket	620075010		
	TENSOLITE NF24Q100	Pin	617175052		
		Socket	620075050		
	TENSOLITE NF26Q100/ JSF Y18	Pin	617175054	617939005	
		Socket	620075021		
	TENSOLITE NF22Q100	Pin	617175040	617939003	
		Socket	620075040		

BMA CONTACTS



Extraction tool **282549001** is used for size 8 BMA contacts.
Environmental BMA contacts are all provided with sealing boots.

Contact size	Cable type	Connector Type	Environmental part number	Non-environmental part number	Frequency range	Max VSWR	Insertion loss
8	SHF5 - SHF5M ⁽¹⁾	Pin	617171011	617171010	DC-18 GHz	1.35	0.13 dB at max frequency (18 GHz)
	RG142	Pin	617171021	617171020	DC-12.4 GHz	1.35	0.11 dB at max frequency (12.4 GHz)
	SHF2.4M ⁽¹⁾ /UT.085/ Harbour SS405/ Times Tflex405	Pin	617171031	617171030	DC-18 GHz	1.35	0.13 dB at max frequency (18 GHz)
	SHF5 - SHF5M ⁽¹⁾	Socket	617071011	617071010	DC-18 GHz	1.35	0.13 dB at max frequency (18 GHz)
	RG142	Socket	617071021	617071020	DC-12.4 GHz	1.35	0.11 dB at max frequency (12.4 GHz)
	SHF3 ⁽¹⁾	Socket	617071041	617071040	DC-18 GHz	1.35	0.13 dB at max frequency (18 GHz)

NOTES:

(1) The BMA contacts which can accommodate SHF cables require a termination by Radiall

LuxCis® Fiber Optic Contacts

The LuxCis® product range is a proven, flexible Fiber Optic interconnect solution offering high speed communication in aerospace and other harsh environments.

OPTICAL PERFORMANCE

	MultiMode (PC) 850 / 1300 nm	SingleMode (UPC) 1310 / 1550 nm
Insertion Loss (IL) Mean (IEC 61300-3-4 Method B)	0.1 dB	0.15 dB
Return Loss (RL) (IEC 61300-3-6)	> 20 dB	> 50 dB

MECHANICAL AND ENVIRONMENTAL CHARACTERISTICS

	Standard	Performance
Thermal cycling	SAE AS 13441 method 1003.1	-55°C/+125°C (cable dependant)
Temperature endurance	TIA/EIA 455-4	1000 h at 125°C (cable dependant)
Vibration	TIA/EIA 455-11	27 Grms
Shock	TIA/EIA 455-14	50 G, 11 ms
Durability	TIA / EIA 364-09	500 cycles ⁽¹⁾
Maintenance	SAE AS 13441 method 2002.1	10 cycles
Cable retention 1.8 mm diameter 900 µm diameter	SAE AS 13441 method 2009.1	68 N 7 N
Humidity	TIA / EIA 455-5	10 cycles / 24 h 90% RH -25°C / +65°C

LUXCIS® CONTACT PART NUMBERING SYSTEM



F725: LuxCis® series

Ferrule type

- 00:** PC ferrule for SingleMode fiber
- 03:** PC ferrule for 50/125 or 62,5/125 µm MultiMode fiber
- 04:** PC ferrule for 100/40 µm MultiMode fiber
- 05:** PC ferrule for 200/230 µm MultiMode fiber
- 50:** APC ferrule for SingleMode fiber

Cable type and diameter

- 118:** 900 µm cable
- 318:** 1.2 mm cable with strengthening members, tight structure
- 419:** 1.6 to 2.2 mm cable, loose structure
- 519:** 1.6 to 2.2 mm cable, tight structure



The sealing plug F718 211 200 is specifically designed to fill the unused LuxCis® Arinc 801 cavities.

NOTES:

- (1) Mating cycles are dependant on connector series
- Radiall can support you with your cable and harness assemblies
- Please contact your sales representative

Signal PC tail Contacts

Selection table for straight PC tail contacts

Contact termination designations are a combination of 2 letters:

- The first letter characterizes the contact plating
R = Pure-tin (RoHS); Z = Tin lead; Y = Gold
- The second letter characterizes the length of the PC tail: A to D
The exact lengths can be found on the assembly kit sections

Contact termination	Contact type	Size 22	Size 20	Size 16	Size 12	Size 8	Size 5
RA	Pin	617205510	617222514	617242510	617259505	617291501	617289506
	Socket	617305500	617322505	617342510	617359505	617391501	617389506
YA	Pin	617205010	617222014	617242010	617259005	617291001	617289006
	Socket	617305	617322005	617342010	617359005	617391001	617389006
ZA	Pin	617205710	617222714	617242710	617259705	617291701	617289706
	Socket	617305700	617322705	617342710	617359705	617391701	617389706
RB	Pin	617205501	617222512	617242508	617259506	617291503	617289504
	Socket	617305501	617322506	617342511	617359506	617391503	617389504
YB	Pin	617205001	617222012	617242008	617259006	617291003	617289004
	Socket	617305001	617322006	617342011	617359006	617391003	617389004
ZB	Pin	617205701	617222712	617242708	617259706	617291703	617289704
	Socket	617305701	617322706	617342711	617359706	617391703	617389704
RC	Pin	617205515	617222513	617242517	617259503	617291504	617289503
	Socket	617305508	617322507	617342513	617359503	617391504	617389503
YC	Pin	617205015	617222013	617242017	617259003	617291004	617289003
	Socket	617305008	617322007	617342013	617359003	617391004	617389003
ZC	Pin	617205715	617222713	617242717	617259703	617291704	617289703
	Socket	617305708	617322707	617342713	617359703	617391704	617389703
RD	Pin	617205509	617222510	617242509	617259507	617291505	617289507
	Socket	617305502	617322509	617342515	617359507	617391505	617389507
YD	Pin	617205009	617222010	617242009	617259007	617291005	617289007
	Socket	617305002	617322009	617342015	617359007	617391005	617389007
ZD	Pin	617205709	617222710	617242709	617259707	617291705	617289707
	Socket	617305702	617322709	617342715	617359707	617391705	617389707
Ins/ext. tool		282522 M81969/14-01	282522001 M81969/39-01	282515 M81969/14-03	282549004 M81969/14-04	282549001 M81969/28-03	282946 M81969/28-01

Quadrax Size 8 Pc Tail Contacts

Selection table for straight PC tail contacts.

Contact termination designations are a combination of 2 letters:









- The first letter characterizes the contact plating
R = Pure-tin (RoHS); Z = Tin lead; Y = Gold
- the second letter characterizes the length: A to D. The exact dimensions of the lengths can be found on the assembly kit sections



Contact termination	Contact type	Part number
RA	Pin	617177512
	Socket	617077512
YA	Pin	617177012
	Socket	617077012
ZA	Pin	617177712
	Socket	617077712
RB	Pin	617177501
	Socket	617077502
YB	Pin	617177001
	Socket	617077002
ZB	Pin	617177701
	Socket	617077702
RC	Pin	617177508
	Socket	617077508
YC	Pin	617177008
	Socket	617077008
ZC	Pin	617177708
	Socket	617077708
RD	Pin	617177513
	Socket	617077513
YD	Pin	617177013
	Socket	617077013
ZD	Pin	617177713
	Socket	617077713
Ext. tool		282549001







Filler Plugs

Filler plugs are dedicated to non-environmental insert cavities.

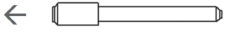
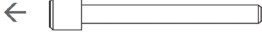
Size	Contact cavity version	Ins/ext	Color	Part Number	Drawing
22	For pin & socket	Rear/Rear	Black	620920	
20			White	610941	
16 for electrical cavity			Blue	620922	
16 for optical cavity			Green	F718211200	
12			Yellow	620923	
8	Pin	Rear/Rear	Nickel	619953	
	Socket		Nickel	619950	
5	Pin	Rear/Rear	White	617930	
	Socket			617931	

Sealing Plugs

Sealing plugs are dedicated to environmental insert cavities.

Size	Contact cavity version	Ins/ext	Color	Part Number	Drawing
22	For pin & socket	Rear/ Rear	Black	616910	
20			Red	616911	
16 for electrical cavity			Green	616912	
				F718211200	
12			Orange	616913	
8			Red	618915	
5				616914013	

The arrows show the direction which you have to insert the plug.

EPXA1 Product Overview

Detailed view of receptacle and plug with accessories for the EPXA1 connector.

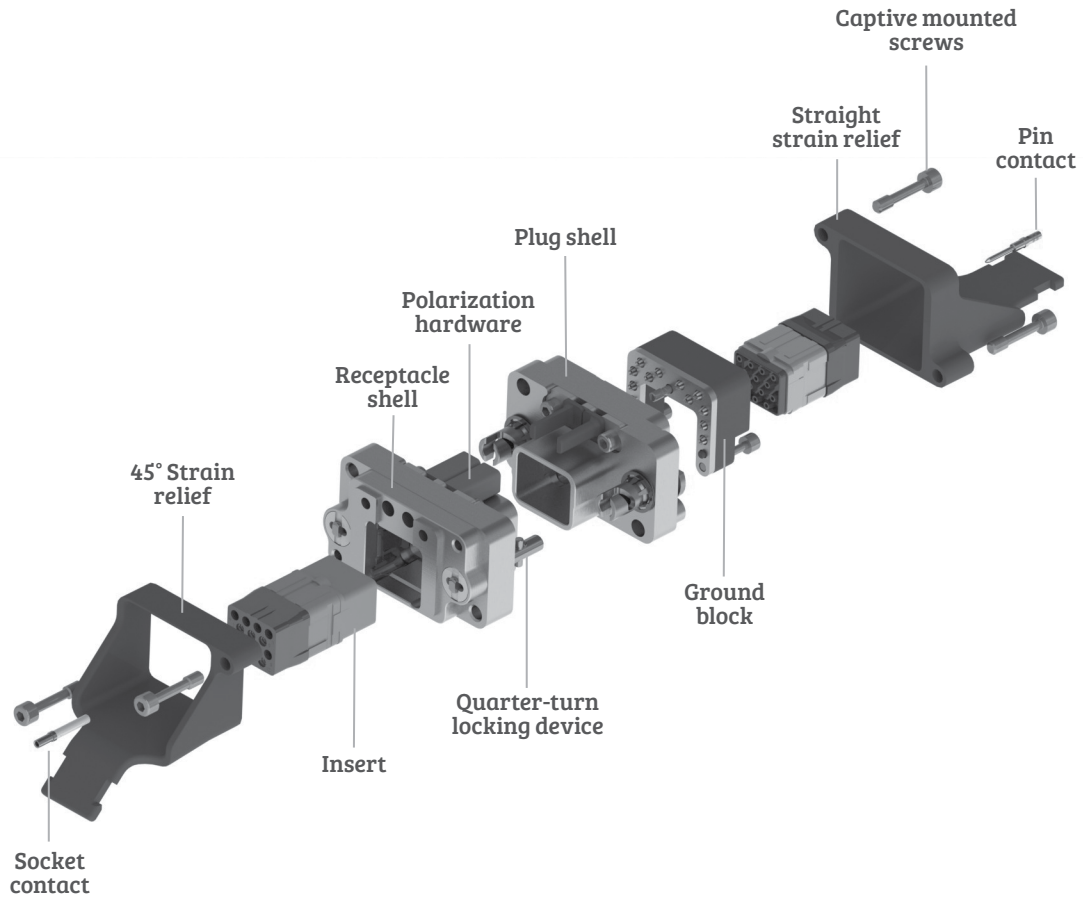

EPXB1 Product Overview

Detailed view of receptacle and plug with accessories for the EPXB1 connector.

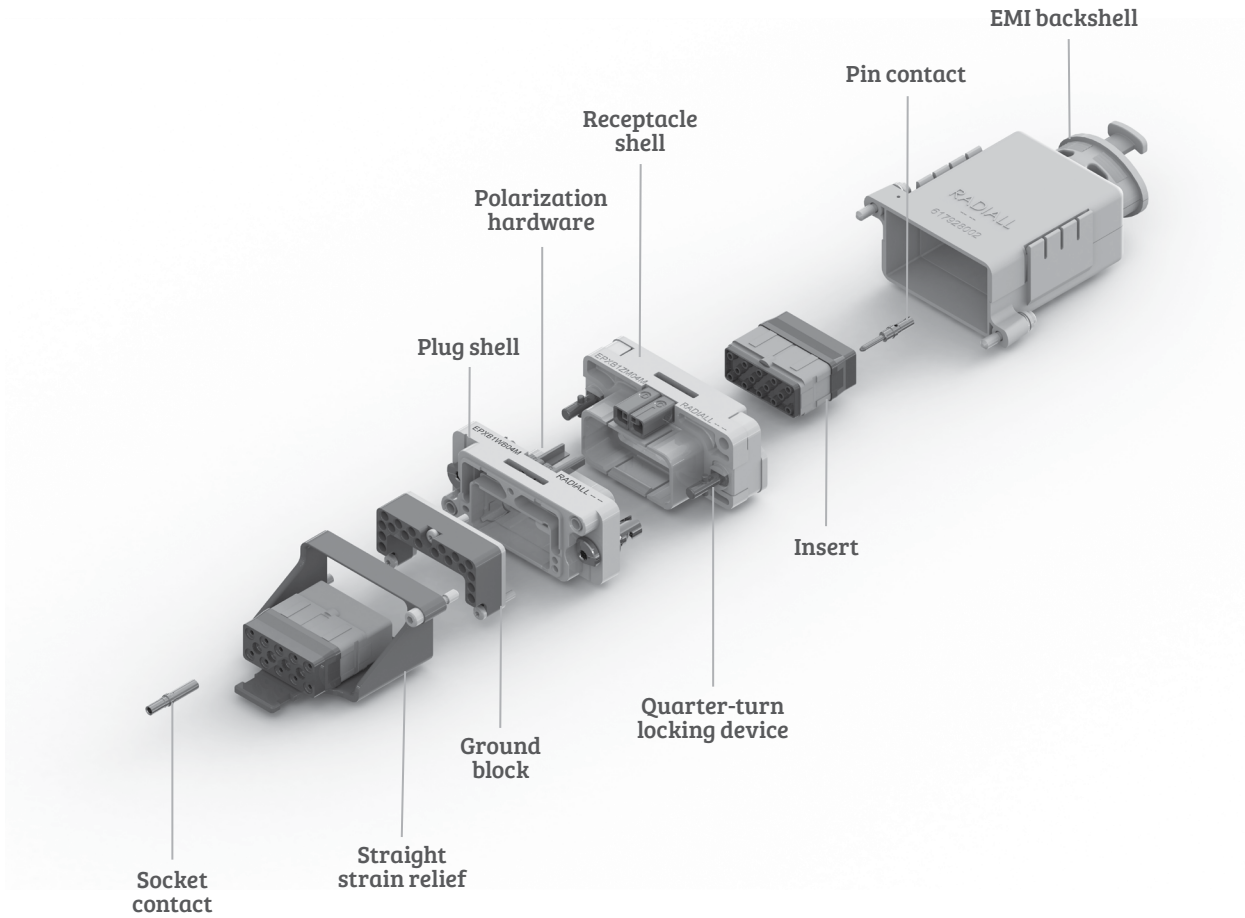

EPX® SERIES

INSERTS

CONTACTS

DISCONNECT APPLICATION

RACK & PANEL APPLICATION

How to Order EPXA1 & EPXB1 Shell

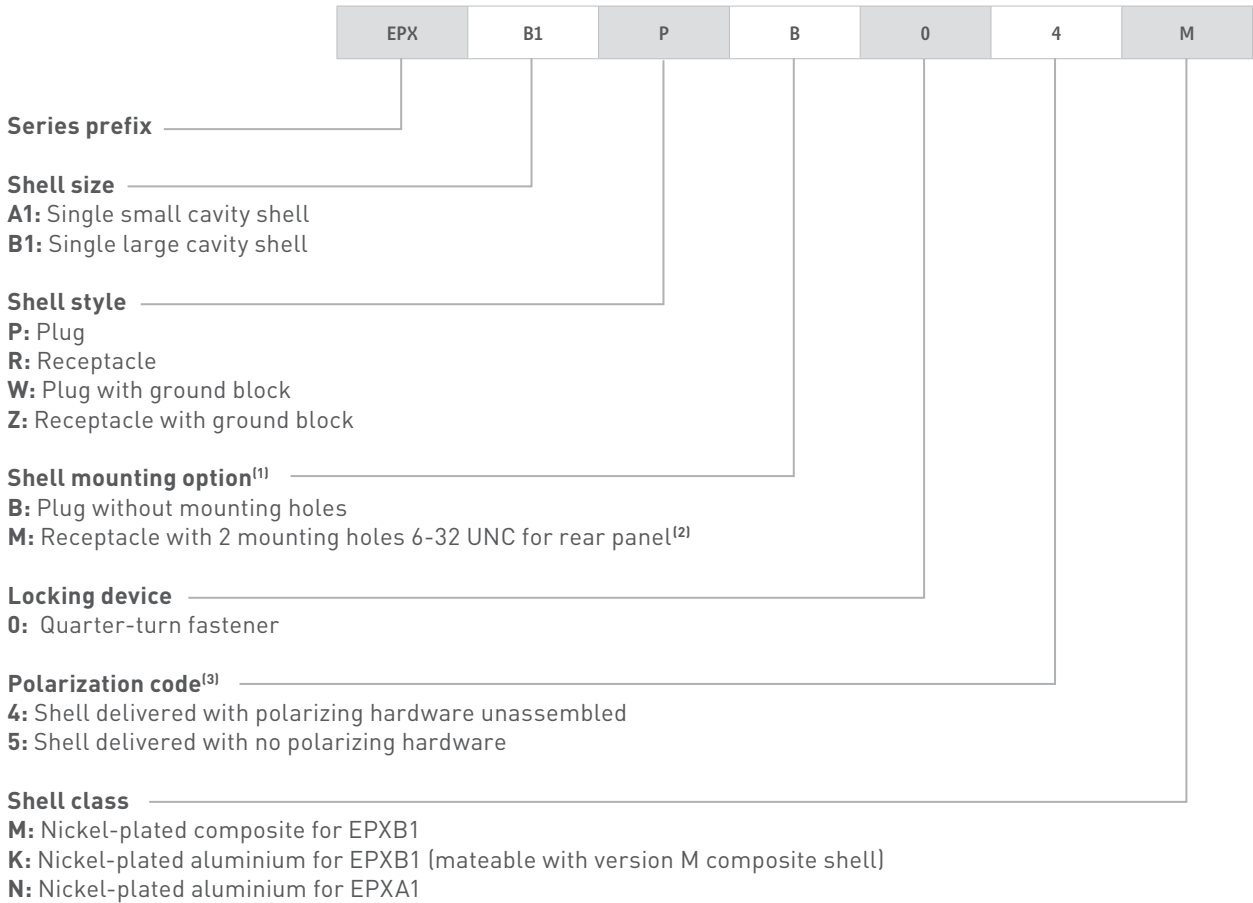

GROUND BLOCK

Radiall provides a unique patented feature by integrating a ground block directly on the shell.

This option permits very short ground terminations

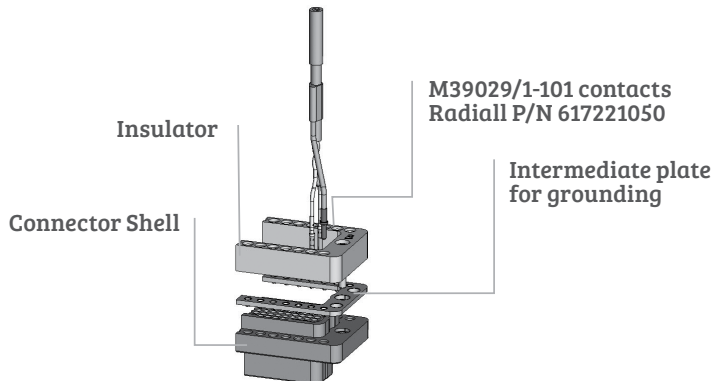

NOTES:

- (1) Recommended locking torque: 1.6Nm (14.16 in-lbs) for metallic shell and 1.1Nm (9.73 in-lbs) max for composite shell
- (2) Self-locking mounting holes are designed for rear panel mounting
- (3) Please see page 1-28 on how to use the polarization device

How to Order EPXA1 & EPXB1 Assembly Kit

Assembly kit is delivered fully assembled including shell with insert mounted, with or without contacts according to the selection.

Tips to help you make a selection:

- You are free to use either pin or socket inserts in EPXA1 & EPXB1 plug or receptacles.
- Crimp contacts can be delivered with a kit, check which contacts would be included on page 1-10.
- If PC tail are selected then all cavities including signal, power and quadrax are populated. Size 5 coax cavities are not populated.
- If PC tail contacts are needed, remember that they are available as pin straight PC tail contacts in receptacles only.

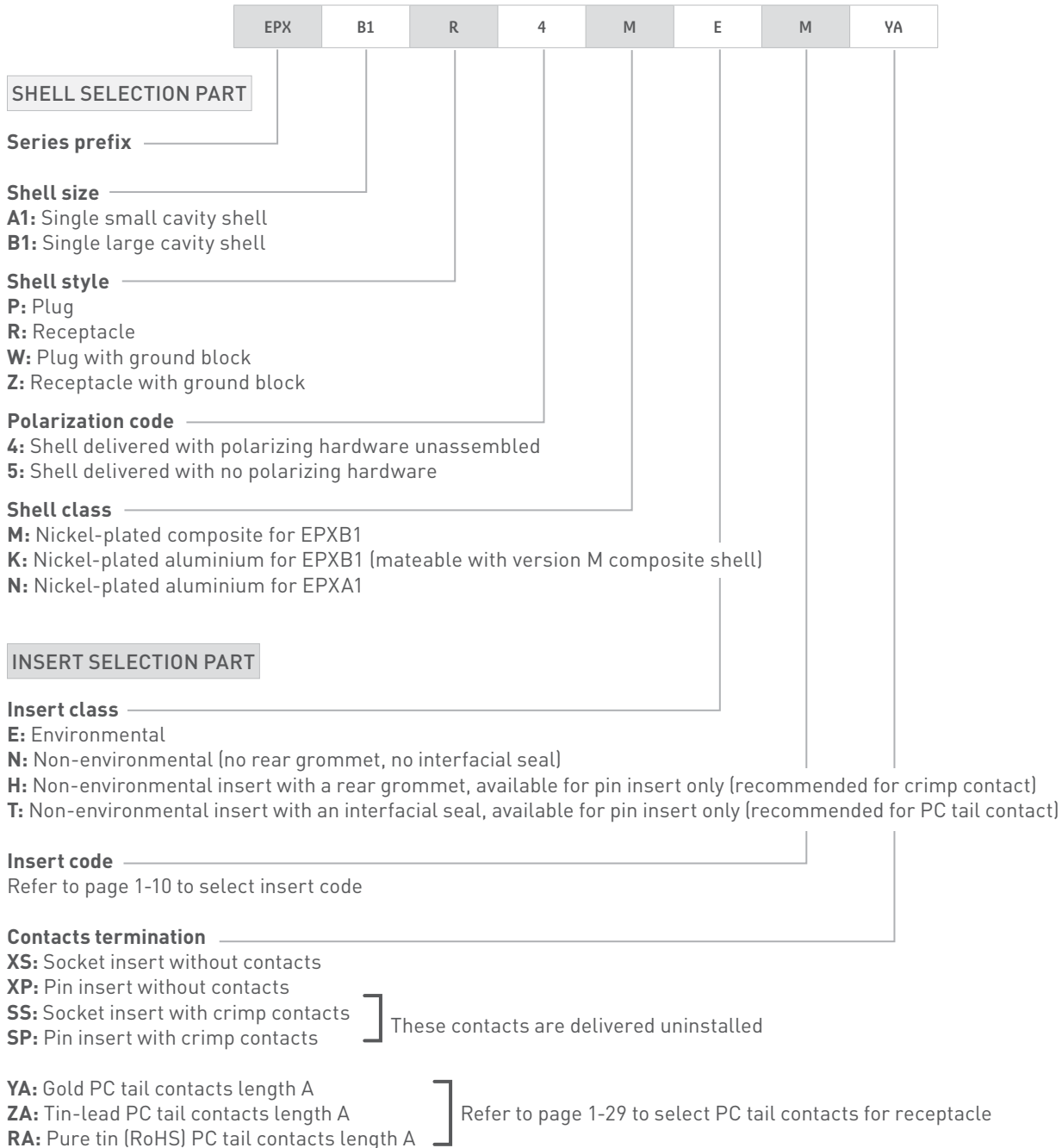

Polarization code for EPXA1 and B1

Caution: Read the polarization code from left to right, the same way the part number marking can be read on the connector.

	Plug	Receptacle
EPXA1		
EPXB1		
Coding device	<p>View A & B View C & D</p>	<p>View A & D View C & B</p>

There are 16 possible codings:

Key position 1	A	A	A	A	B	B	B	B	C	C	C	C	D	D	D	D
Key position 2	A	B	C	D	A	B	C	D	A	B	C	D	A	B	C	D

Contact termination for EPXB1

Aluminium and composite shell versions.

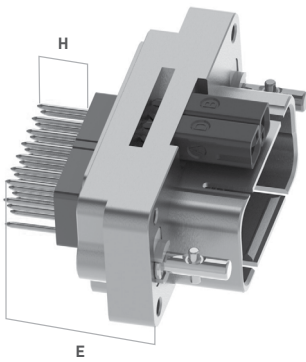
**Straight PC Tail contact termination**

Min Length E mm (inch)	Min Length H mm (inch)	Gold	Tin-lead	Pure tin (RoHS)
16.20 (0.637) ⁽¹⁾	/	YA	ZA	RA
19.40 (0.763) ⁽¹⁾	/	YB	ZB	RB
21.25 (0.836) ⁽¹⁾	/	YC	ZC	RC
25.20 (0.992)	5.40 (0.212)	YD	ZD	RD

NOTE:

(1) These PC tail lengths are not compatible with EPXBE and EPXBH inserts

INSERTS

CONTACTS

DISCONNECT APPLICATION

RACK & PANEL APPLICATION

EPXA1 Shell Dimensions

WITH GROUND BLOCK

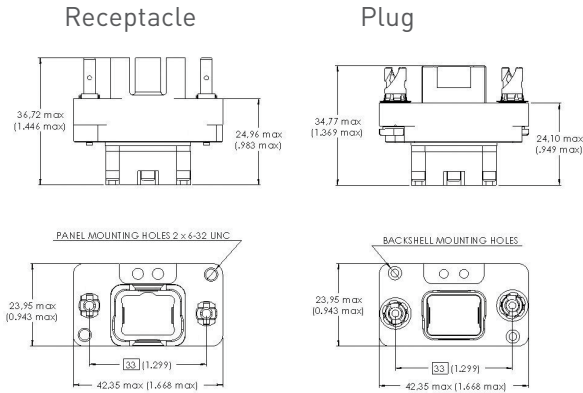

WITHOUT GROUND BLOCK

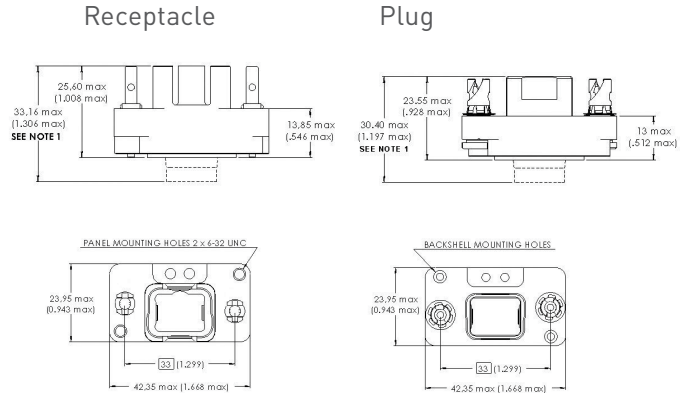

SINGLE PANEL CUT OUT (2)

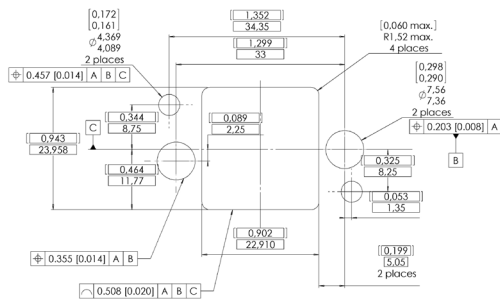

MULTIPLE PANEL CUT OUT (2)

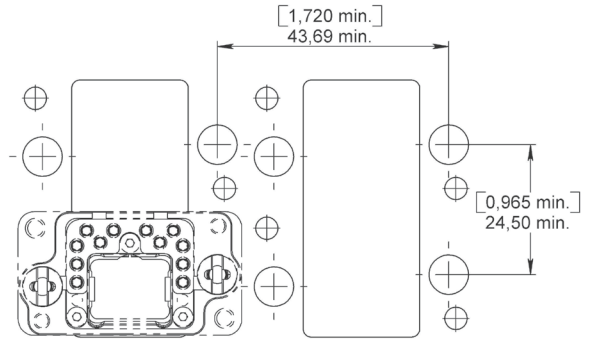

EPXA1 Shell Weights

Weights include the shell with polarization hardware.

EPXA1	Shell style	Weight
CLASS N	P	27.0 g (0.95 oz)
	R	33.0 g (1.16 oz)
	W	35.0 g (1.23 oz)
	Z	41.0 g (1.45 oz)

NOTES:

- (1) Maximum dimension for insert with grommets
For insert without grommet maximum dimensions will be for receptacle 25.55mm (1.006in) and for the plug 23.52mm (0.926in)
- (2) Rear mounting side view with key post oriented to the upper side

EPXB1 Shell Dimensions

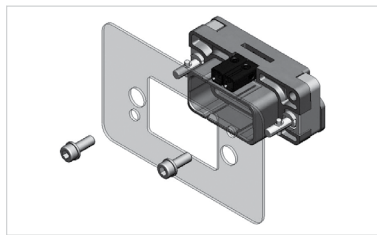

WITH GROUND BLOCK

WITHOUT GROUND BLOCK

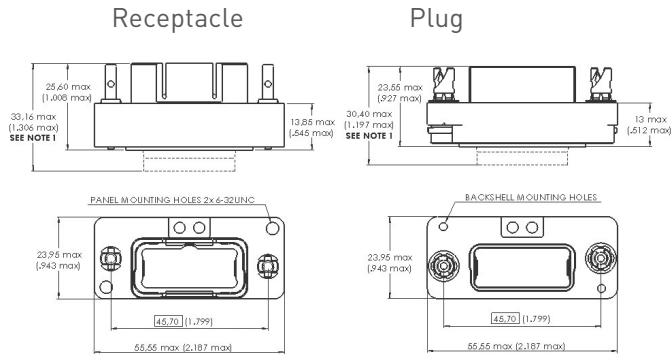
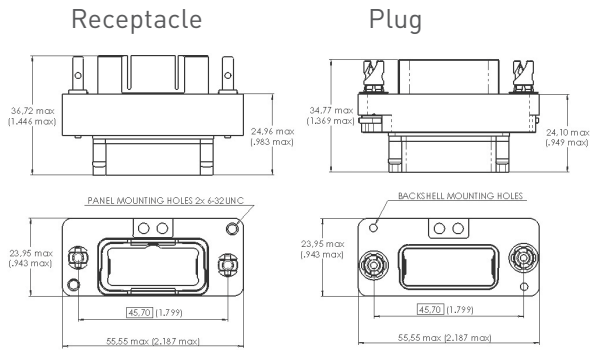

SINGLE PANEL CUT OUT (2)

MULTIPLE PANEL CUT OUT (2)

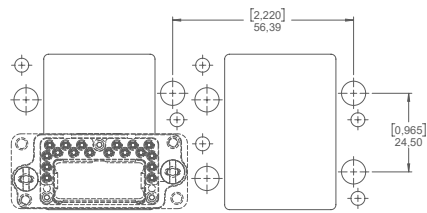
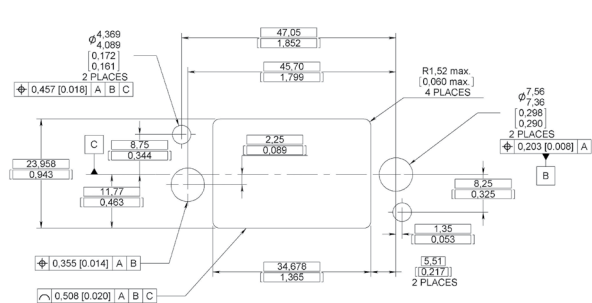

EPXB1 Shell Weights

Weights include the shell with polarization hardware.







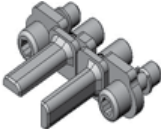
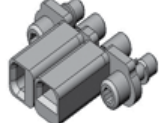

EPXB1	Shell style	Weight
CLASS K	P	27.0 g (0.95 oz)
	R	33.0 g (1.16 oz)
	W	37.0 g (1.31 oz)
	Z	43.0 g (1.52 oz)
CLASS M	P	25.0 g (0.88 oz)
	R	33.0 g (1.16 oz)
	W	35.0 g (1.23 oz)
	Z	43.0 g (1.52 oz)

NOTES:



- (1) Maximum dimension for insert with grommet. For insert without grommet: Insert is flush to the shell. Maximum dimension for the receptacle is 25.55 mm (1.006 in) and for the plug is 23.52 mm (0.926 in). For insert with optical contacts: the maximum dimension for the receptacle is 38.70 mm (1.524 in) and the plug is 36.00 mm (1.418 in)
- (2) Rear mounting side view with polarization hardware oriented to the upper side

EPXA1 & EPXB1 Spare Parts

SPARE PARTS & DUST CAPS

	Part number		Description
	EPXA	EPXB1	
	617980032	-	Polarization kit for plug connector
	617980033	-	Polarization kit for receptacle connector
	-	617980030	Polarization post
	-	617980031	Polarization key
	617954006	617954008	Dust cap for plug shell (pink color)
	617954007	617954009	Dust cap for receptacle shell (pink color)
	617954044	617954034	ESD dust cap for plug shell (black color)
	617954045	617954028	ESD dust cap for receptacle shell (black color)
	617929033	-	Sealing inserts for fly away applications: mateable with pin insert
	-	617929023	
	617929032	-	Sealing inserts for fly away applications: mateable with socket insert
	-	617929022	

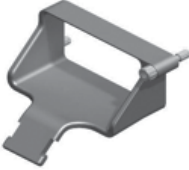
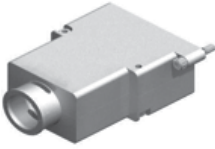
STRAIN RELIEFS AND EMI BACKSHELLS

	Part number		Description
	EPXA1	EPXB1	
	617921030	617921029	Straight strain relief (composite)
	617921032	617921031	45° strain relief (composite)
	-	617924016	Straight EMI backshell (Nickel-plated aluminium)
	-	617928002	Straight EMI backshell (Nickel-plated composite)
	-	617921044	Fiber Optic backshell (composite)

NOTE:

For mounting instructions, please contact Radiall

EPXB2 Connectors

Radiall's EPXB2 disconnect connectors have been widely used in the aerospace industry for more than 10 years. Meant to be used in cable-to-cable and PCB-to-cable applications, EPXB2 connectors exceed civil aerospace market expectations in terms of high density, quick installation, and cost and weight savings.

Standardized by EN4644 European standard, Radiall's EPX® has been recognized as the leading rectangular modular connector and used in major commercial and business jet aircrafts. EPXB2 connectors are designed to cover any applications including:

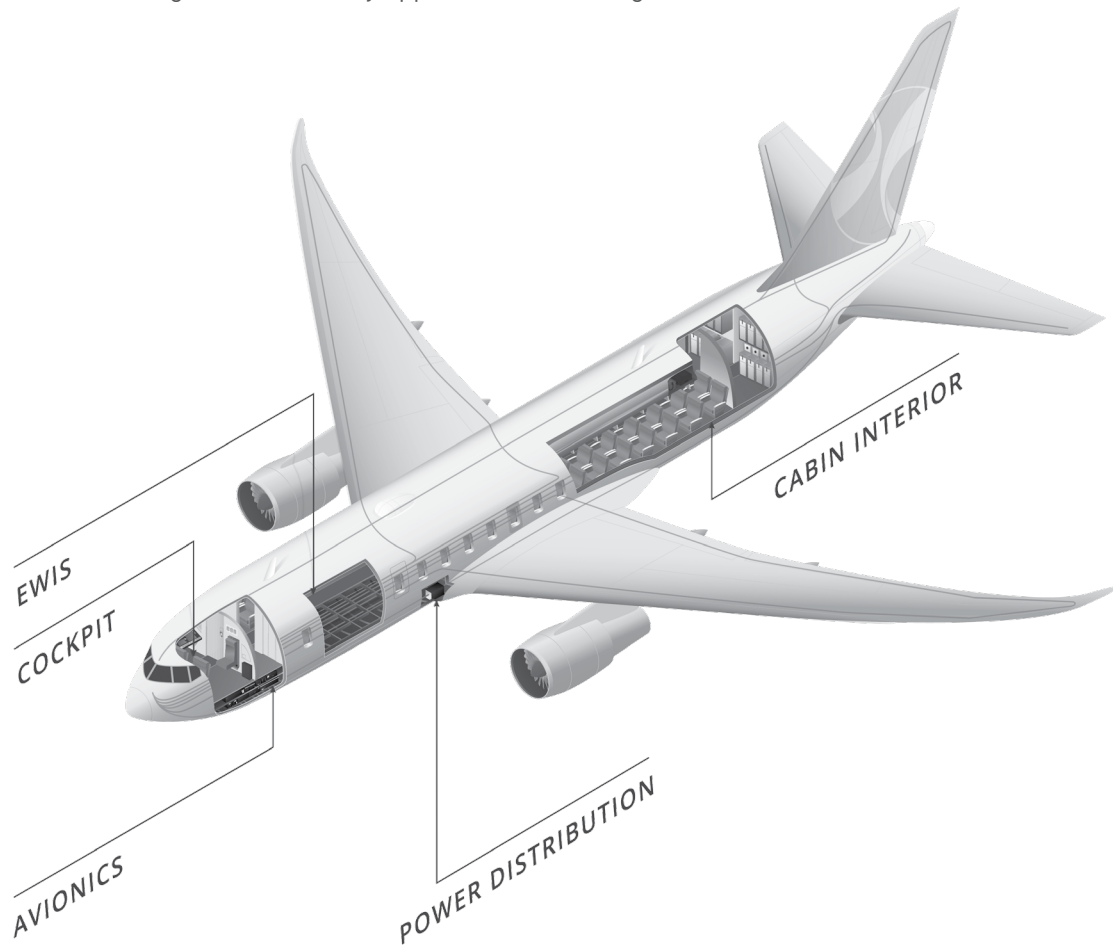

EWIS

EPXB2 provides easy maintenance, and high reliability which are key characteristics of EWIS environments.



CABIN INTERIOR

EPXB2 combines high speed data with space savings to serve the last generations of cabin systems.



COCKPIT

EPXB2 offers simplified and intuitive installation for Fiber Optic and signal connections that are critical in cockpit design.



AVIONICS

EPXB2 compactness, lightweight and robust design efficiently support avionics systems needs.



POWER DISTRIBUTION

EPXB2 stackable and segregated features make it the perfect solution for power distribution.

EPXB2 Product Overview

Detailed view of receptacle and plug with accessories for the EPXB2 disconnect connector.

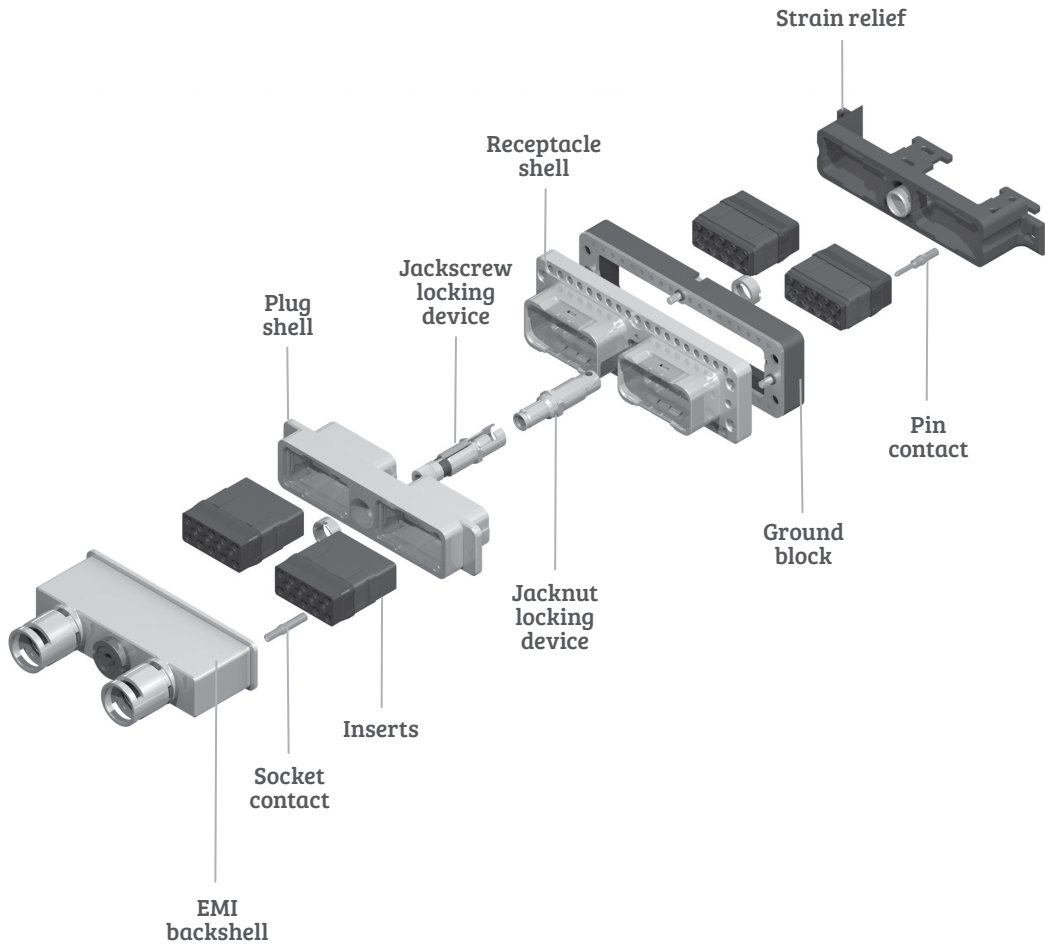

EPX® SERIES

INSERTS

CONTACTS

DISCONNECT APPLICATION

RACK & PANEL APPLICATION

EPXB2 Range Overview

Modular and flexible, EPXB2 answers all disconnect connecting needs with the use of a limited number of components. With a large variety of shells and one range of inserts, contacts and accessories, EPXB2 range is completely expandable and fits to your exact needs. You can mix and match solutions to build your connector with:

SHELL CLASSES - (ALL NICKEL PLATED)

- 

N
Aluminium
- 

M
Composite
- 

J
Weight Optimized
Aluminium

SHELL STYLES

Defining connector types (plug or receptacle) and their key features.

- 

Classic
EPXB2
- 

Ground Block
- 

Flange
- 

Bulkhead
- 

iEPX

EPXB2 GALAXY

Plugs

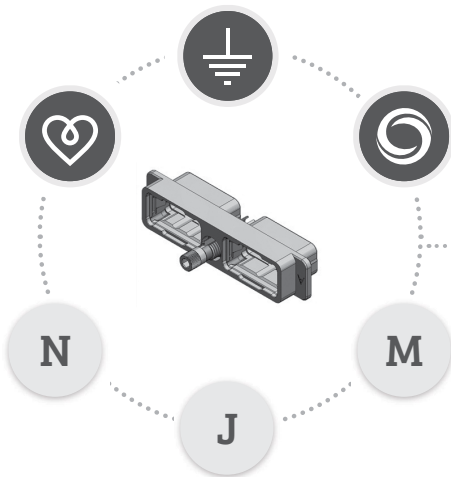

Receptacles

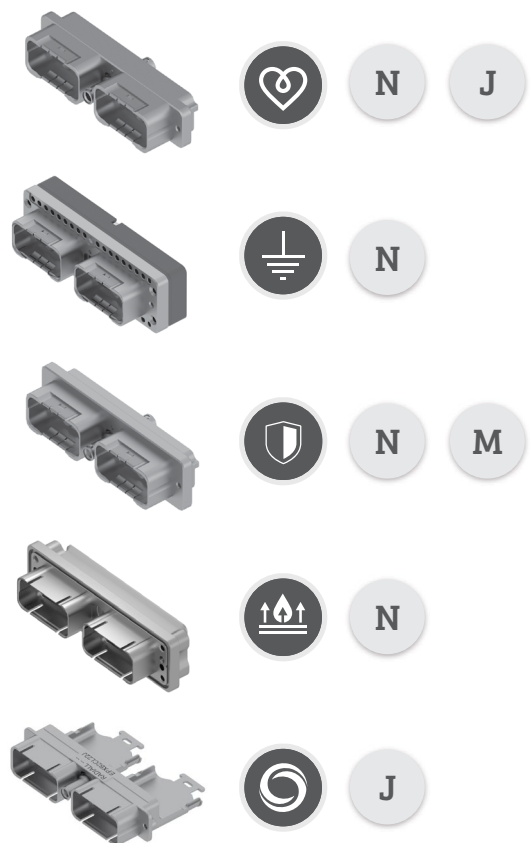

EPXB2 Latest Innovations**iEPX**

Radiall expands the EPX® series by offering iEPX, a new weight optimized EPXB2 shell designed to be used in disconnect panel applications. With an integrated strain relief and EMI backshell to press-in, iEPX provides EMI shielding while reducing cost and weight.

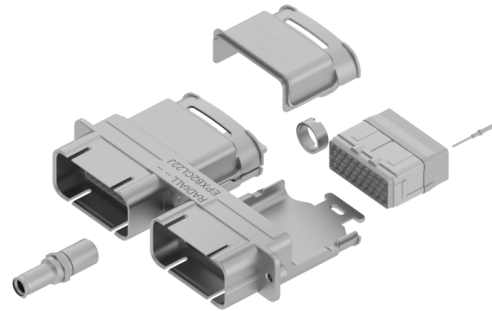
**FEATURES AND BENEFITS:**

- Quick and easy to terminate
- Lightweight
- Prevents FOD
- Cable-to-cable connection
- Integrated strain relief

MIX AND MATCH:

- Fully intermateable with all EPXB2 plugs and receptacles.
- Modular and comprehensive range: iEPX uses all contacts and inserts from EPX® range

EPX® BULKHEAD

Radiall's EPXB2 Bulkhead receptacle is a perfect solution for disconnect panel sealing applications. Combining EPX® proven technology with Bulkhead functionality, EPXB2 Bulkhead modular connectors provide effective panel sealing with a user friendly and cost saving approach.

With EPXB Bulkhead pin insert range, Bulkhead receptacle provides permanent sealing between two zones with different environmental conditions.

FEATURES AND BENEFITS:

- Modular
- Competitive offer
- Optimized and mature design
- Easy and economical integration in the BOM
- PCB-to-cable or cable-to-cable connection

MIX AND MATCH:

- Fully intermateable with all EPXB2 plugs
- Uses EPX® broad range of accessories and contacts including signal, power, quadax and fiber optics

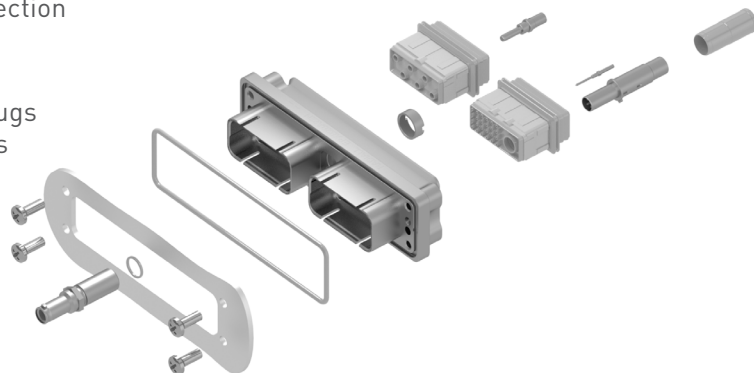

How to Order EPXB2 Shell

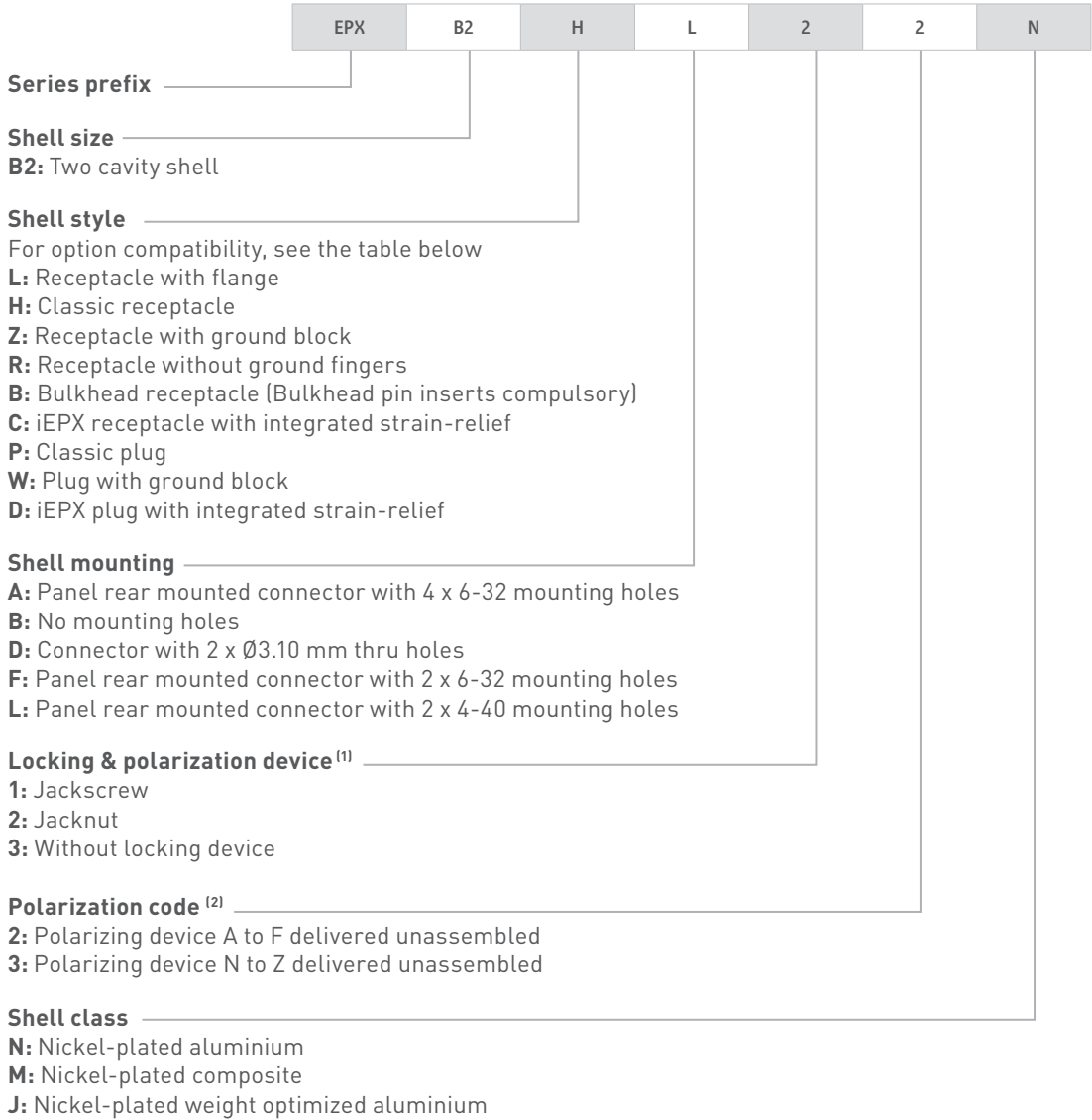

AVAILABLE SHELL MOUNTING

	Shell style	A (4 x 6.32 UNC)	B (no holes)	D (2 x Ø3.10mm)	F (2 x 6.32 UNC)	L (2 x 4.40 UNC)
Class N	L			x	x	x
	H		x	x	x	x
	Z	x	x			
	R	x				
	P		x	x		x
	W	x	x			
	B	x				
Class J (weight optimized aluminium)	H					x
	C					x
	P		x			
	D		x			
Class M (composite)	L			x		x
	P		x	x		x

NOTES:

(1) Jackscrew/Jacknut can be mounted on either plug or receptacle shell. However, the standard options are:

- Jackscrew for plug shells
- Jacknut for receptacle shells

(2) Please see page 1-40 for how to use the polarization coding

How to Order EPXB2 Assembly Kit

Assembly kits are delivered fully assembled including shell with inserts mounted, with or without contacts according to the selection. When selecting your insert codes, do not forget to place them in the order you want them assembled. Locking and polarizing devices are delivered uninstalled.

Tips to help you make a selection:

- You are free to use either pin or socket inserts in EPXB plug or receptacle
- Crimp contacts can be delivered with a kit, check which contacts will be included on page 1-10
- PC tail contacts can also delivered with a kit. Remember that only straight pin PC tail contacts are available, and in receptacle only
- If PC tail contacts are selected then all cavities including signal, power and quadrax are populated. Size 5 coax cavities are not populated

All connector inserts will use the same insert class and the same contact termination. iEPX is not compatible with insert 3Q3 in environmental class.

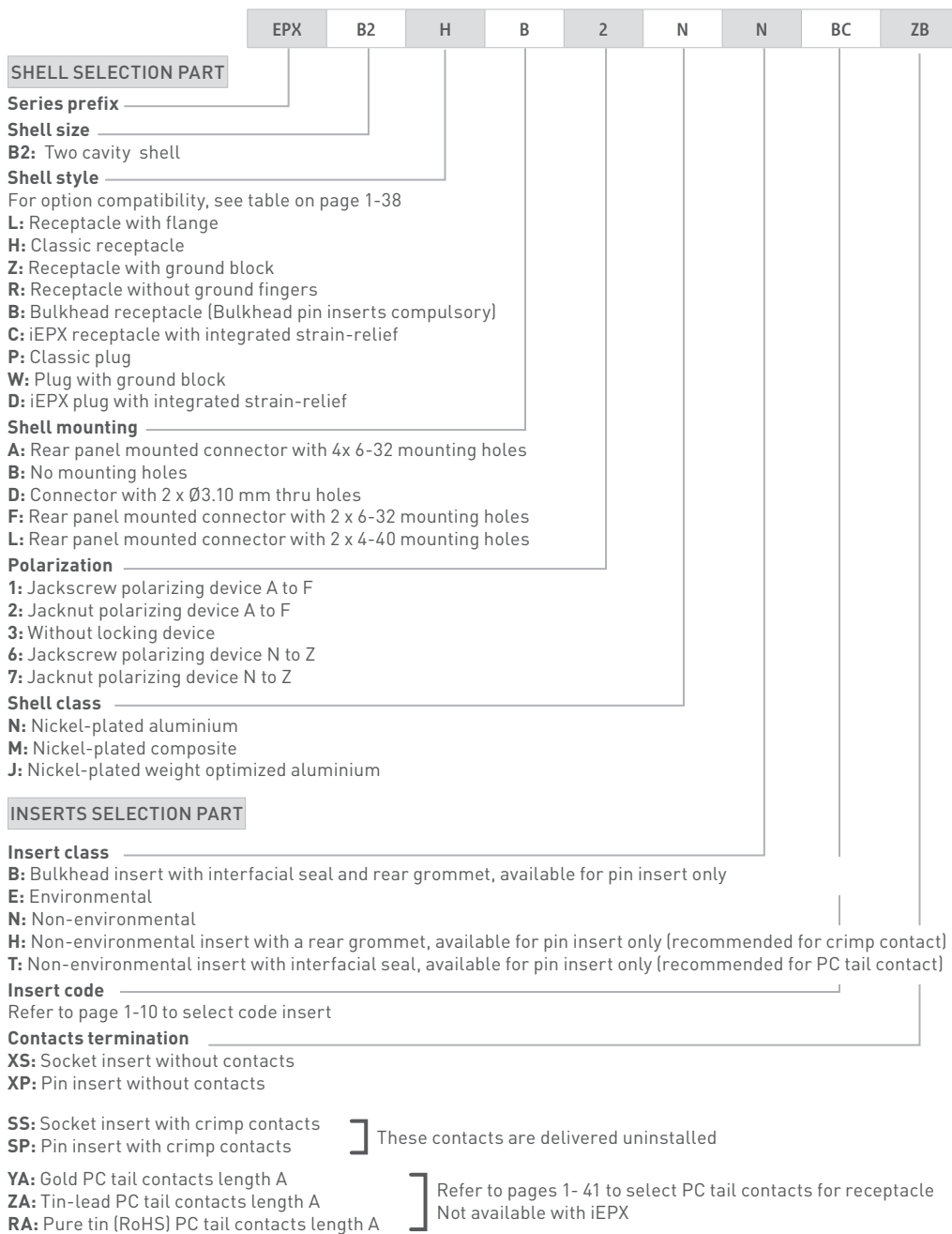





EPXB2 Polarization Code

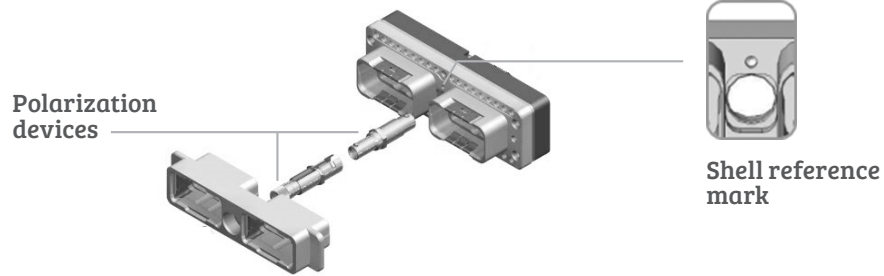

As a standard, jackscrews shall be installed in plugs and jackscrews in receptacle shells, however, jackscrew/jacknut can be installed in either plugs and receptacles. The nut can be fixed with your automatic screwdriver and the tool bit we provide (P/N 282664).

Tip: use the shell reference mark (located at the top of the locking cavity) to choose keying position.

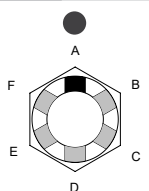
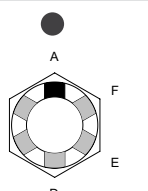
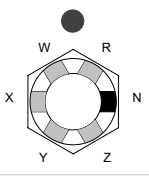
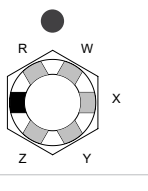
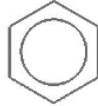

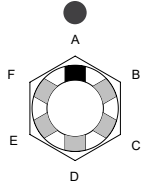
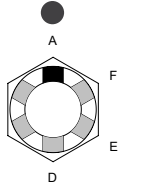
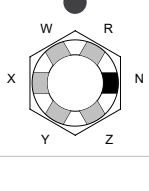
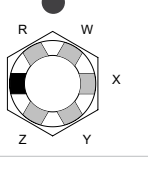
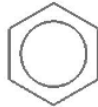
		Keying position		Available as	
		Receptacle	Plug	Standard	Bulkhead
 <p>Jacknut</p>	From A to F			617980029	617980066
	From N to Z			617980028	617980067
	Universal			617980022	N/A
 <p>Jackscrew</p>	From A to F			617980012	N/A
	From N to Z			617980013	N/A
	Universal			617980023	N/A

● Shell reference mark

Contacts Termination for Receptacles

EPXB2 COMPOSITE SHELL

Straight PC Tail contact termination				
Min Length E mm (inch)	Min Length H mm (inch)	Gold	Tin-lead	Pure tin (RoHS)
14.20 [0.559] ⁽¹⁾	/	YA	ZA	RA
17.35 [0.683] ⁽¹⁾	/	YB	ZB	RB
19.20 [0.755] ⁽¹⁾	/	YC	ZC	RC
23.10 [0.909]	5.40 [0.212]	YD	ZD	RD

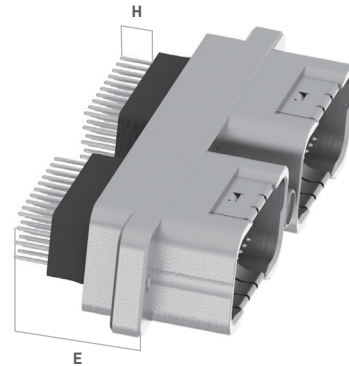

EPXB2 WEIGHT OPTIMIZED ALUMINIUM AND ALUMINIUM SHELL

Straight PC Tail contact termination				
Min Length E mm (inch)	Min Length H mm (inch)	Gold	Tin-lead	Pure tin (RoHS)
14.55 [0.572] ⁽¹⁾	/	YA	ZA	RA
17.75 [0.698] ⁽¹⁾	/	YB	ZB	RB
19.55 [0.769] ⁽¹⁾	/	YC	ZC	RC
23.50 [0.925]	5.40 [0.212]	YD	ZD	RD

NOTE:

(1) These PC tail lengths are not compatible with EPXBE, EPXBH and EPXBB inserts

GROUND BLOCK

Radiall provides a unique patented feature by integrating a ground block directly on the shell.

This option permits very short ground terminations

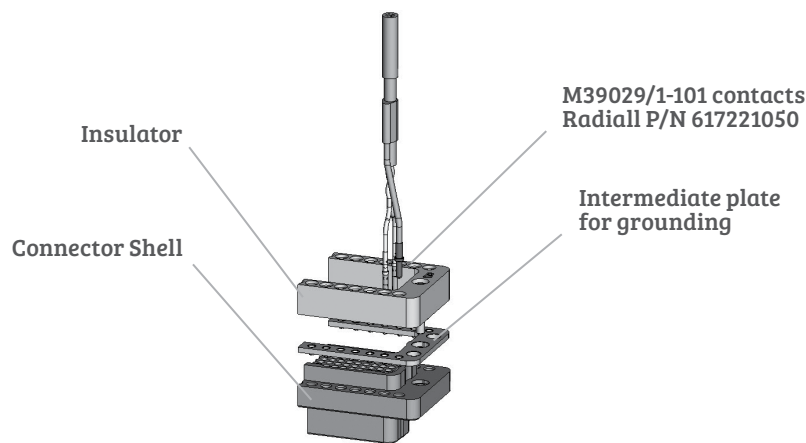

EPXB2 Aluminium Shell Dimensions

CLASS N&J

Classic

Receptacle (HL)

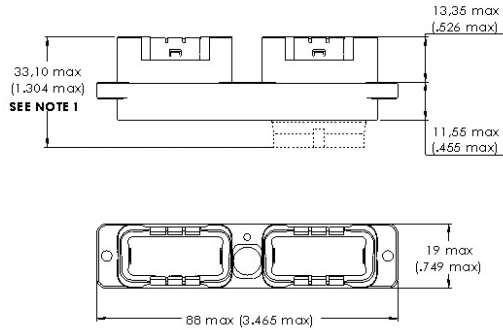

Plug (PB)

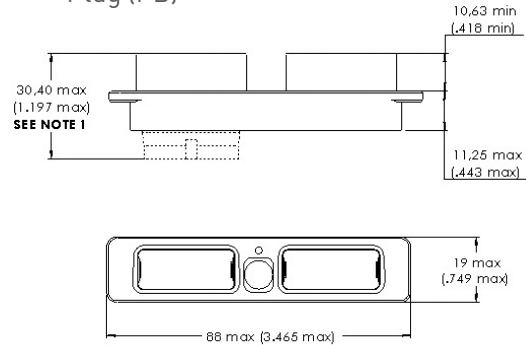

CLASS N

Ground Block

Receptacle (ZA)

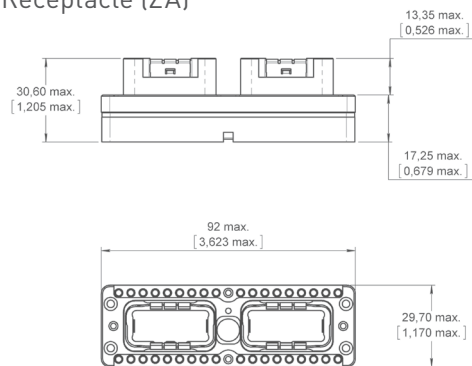

Plug (WA)

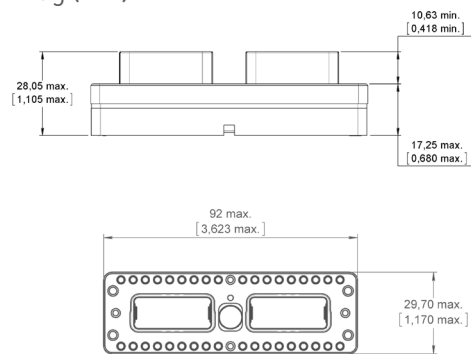

Bulkhead

Receptacle (BA)

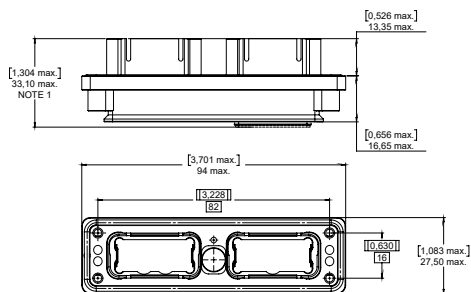

NOTES:

- (1) For insert with grommet: maximum dimension is the one shown in the drawing
- For insert without grommet: insert is flush to the shell. Maximum dimension for the receptacle is 25.55 mm (1.006 in) and for the plug is 23.52 mm (0.926 in)
- For insert with optical contacts: the maximum dimension for the receptacle is 38.70 mm (1.524 in) and for the plug is 36.00 mm (1.418 in)

EPXB2 Aluminium Shell Dimensions

CLASS J

iEPX

Receptacle (CL)

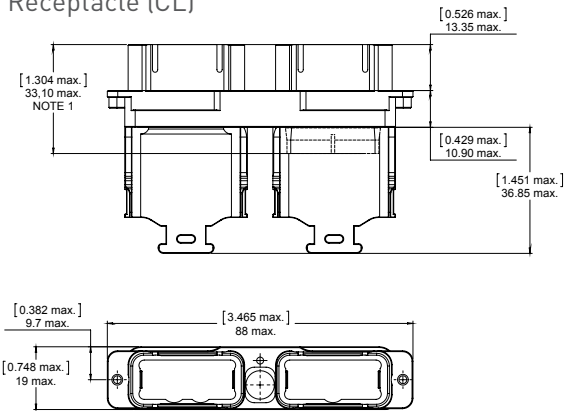

Plug (DB)

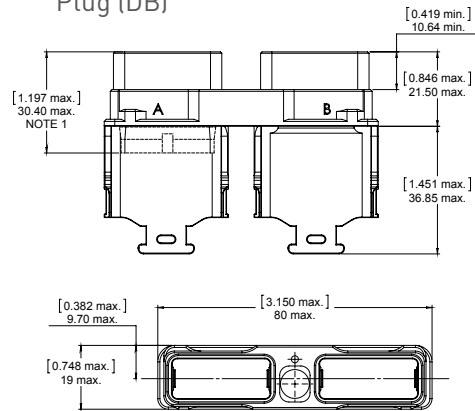

SINGLE PANEL CUT OUT

Class N & J

Shell mounting code D, F and L

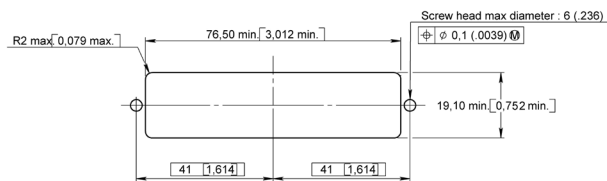

Shell mounting code A

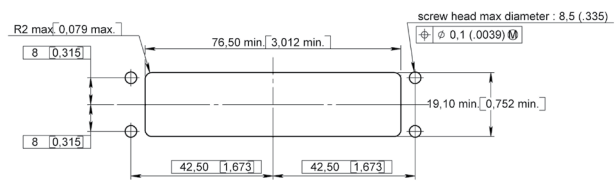

Class N - Bulkhead receptacle

Shell mounting code A

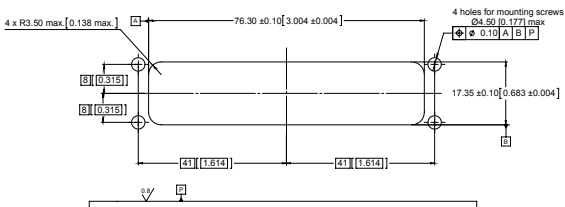

MULTIPLE PANEL CUT OUT

Class N & J

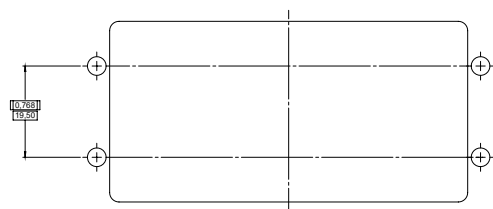

NOTES:

[1] For insert with grommet: maximum dimension is the one shown in the drawing

For insert without grommet: insert is flush to the shell. Maximum dimension for the receptacle is 25.55 mm (1.006 in) and for the plug is 23.52 mm (0.926 in)

For insert with optical contacts : the maximum dimension for the receptacle is 38.70 mm (1.524 in) and for the plug is 36.00 mm (1.418 in)

EPXB2 Composite Shell Dimensions

CLASS M

Receptacle (LL)

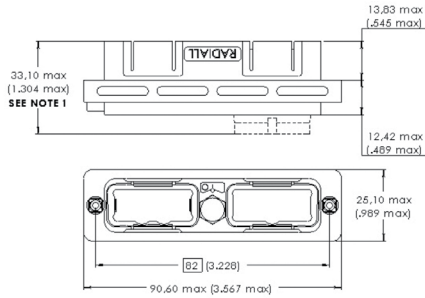

Plug (PB)

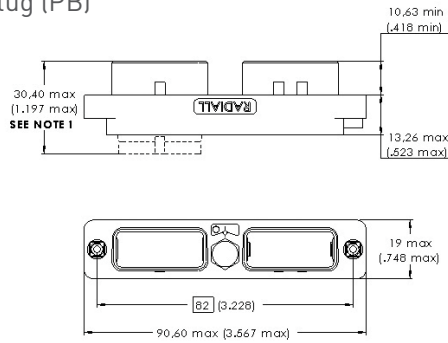

SINGLE PANEL CUT OUT

Shell mounting code D and L

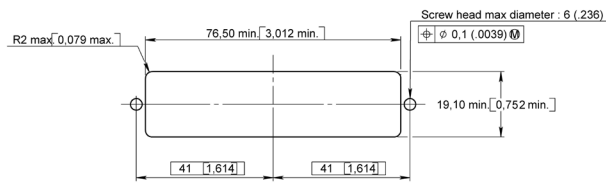

MULTIPLE PANEL CUT OUT

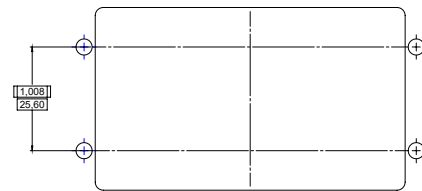

NOTE:

- (1) For insert with grommet (EPXBE and EPXBH): maximum dimension is the one shown in the drawing
- For insert without grommet (EPXBN): insert is flush to the shell. Maximum dimension for the receptacle is 25.55 mm (1.006 in) and for the plug is 23.52 mm (0.926 in)
- For inserts with optical contacts: the maximum dimension for the receptacle is 38.70 mm (1.524 in) and the plug is 36.00 mm (1.418 in)

EPXB2 Weights

Weights include the shell with no polarization. If locking is needed, please add the following weights:

- Jackscrew: 9.0 g
- Jacknut: 7.8 g
- Bulkhead jacknut: 8.7 g

Class	Shell mounting	A	B	D	F	L
	Shell style					
Class N	L	-	-	45 g (1.59 oz)	45 g (1.59 oz)	45 g (1.59 oz)
	H	-	35 g (1.23 oz)	36 g (1.27 oz)	36 g (1.27 oz)	36 g (1.27 oz)
	Z	80 g (2.82 oz)	80 g (2.82 oz)	-	-	-
	R	45 g (1.59 oz)	-	-	-	-
	P	-	30 g (1.06 oz)	30 g (1.06 oz)	-	30 g (1.06 oz)
	W	75 g (2.65 oz)	75 g (2.65 oz)	-	-	-
	B	50 g (1.76 oz)	-	-	-	-
Class J	H	-	-	-	-	27 g (0.95 oz)
	C	-	-	-	-	35 g (1.23 oz)
	P	-	25 g (0.88 oz)	-	-	-
	D	-	30 g (1.06 oz)	-	-	-
Class M	L	-	-	35 g (1.23 oz)	-	35 g (1.23 oz)
	P	-	24 g (0.85 oz)	25 g (0.88 oz)	-	25 g (0.88 oz)







INSERTS

CONTACTS

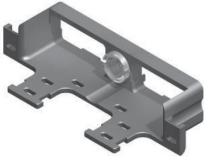
DISCONNECT APPLICATION

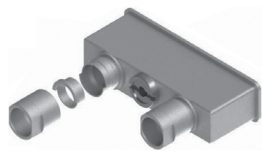
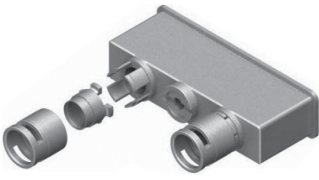
RACK & PANEL APPLICATION

EPXB2 Accessories

	Part number	Description
	617922007	Straight strain relief (composite)
	617922014	Straight strain relief for Fiber Optic cable (anodized aluminium)
	617928100	Straight EMI backshell (nickel-plated composite)
	617925052	EMI backshell for braid shield termination (nickel-plated aluminium)
	617925054	EMI backshell for screened twisted pair cables (nickel-plated aluminium)
	617925056	Backshell for large sized wire harnesses (nickel-plated aluminium) ⁽¹⁾
	617925013	EMI Backshell for iEPX connectors (aluminium)
	617922029	Fiber Optic backshell (composite)

NOTE:

(1) Not compatible with jackscrew

EPXB2 Spare Parts

	Part number	Description
	617954101	Grounding spring (for EPXB2 aluminium only)
	617980029	Jacknut – A/B/C/D/E/F
	617980028	Jacknut – N/R/W/X/Y/Z
	617980022	Universal jacknut
	617980066	Bulkhead Jacknut A/B/C/D/E/F
	617980067	Bulkhead Jacknut N/R/W/X/Y/Z
	617980012	Jackscrew – A/B/C/D/E/F
	617980013	Jackscrew – N/R/W/X/Y/Z
	617980023	Universal jackscrew
	617954002	Dust cap for plug shell (pink color)
	617954003	Dust cap for receptacle shell (pink color)
	617954004	ESD dust cap plug shell (black color)
	617954005	ESD dust cap receptacle shell (black color)
	617929023	Sealing inserts for fly away applications: mateable with pin insert
	617929022	Sealing inserts for fly away applications: mateable with socket insert







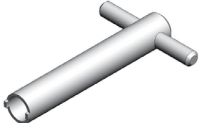

INSERTS

CONTACTS

DISCONNECT APPLICATION

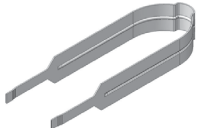
RACK & PANEL APPLICATION

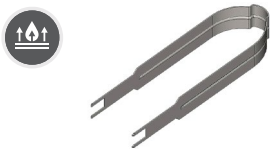
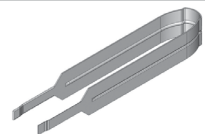
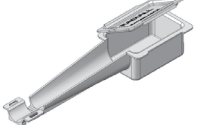
Disconnect Tools

	Part number	Description	To be used with		
			EPXA1	EPXB1	EPXB2
	282664	1/4 inch hex. screwdriver bit to affix the nut of the jackscrew or the jacknut to the EPXB2 accessories			X
	282665	Spigot wrench to affix the nut of the jackscrew or the jacknut to the EPXB2 accessories			X
	282666	Allen wrench for 1/4 turn fastener (3/32 inch)	X	X	
	282666002	Allen wrench for rear accessories (5/64 inch)		X	
	282666001	Allen wrench for jackscrew (9/64 inch)			X
	282521002	Insert extraction tool		X	X
	282521004	Right angle insert extraction tool		X	X
	282521007	Bulkhead insert extraction tool			X
	282521005	Insert extraction tool	X		
	617954020	Plastic box to protect wired inserts during handling	X	X	X
	F780855000	Hexagonal key 2mm (5/64inch) Flats for sleeve holder removal		X	X
	282668001	Tweezers to change polarizing posts and keys		X	

EPX Rack and Panel for LRM - Product Overview

RACK AND PANEL

Detailed view of receptacle and plug with accessories for the EPXB3 Rack and Panel connector.

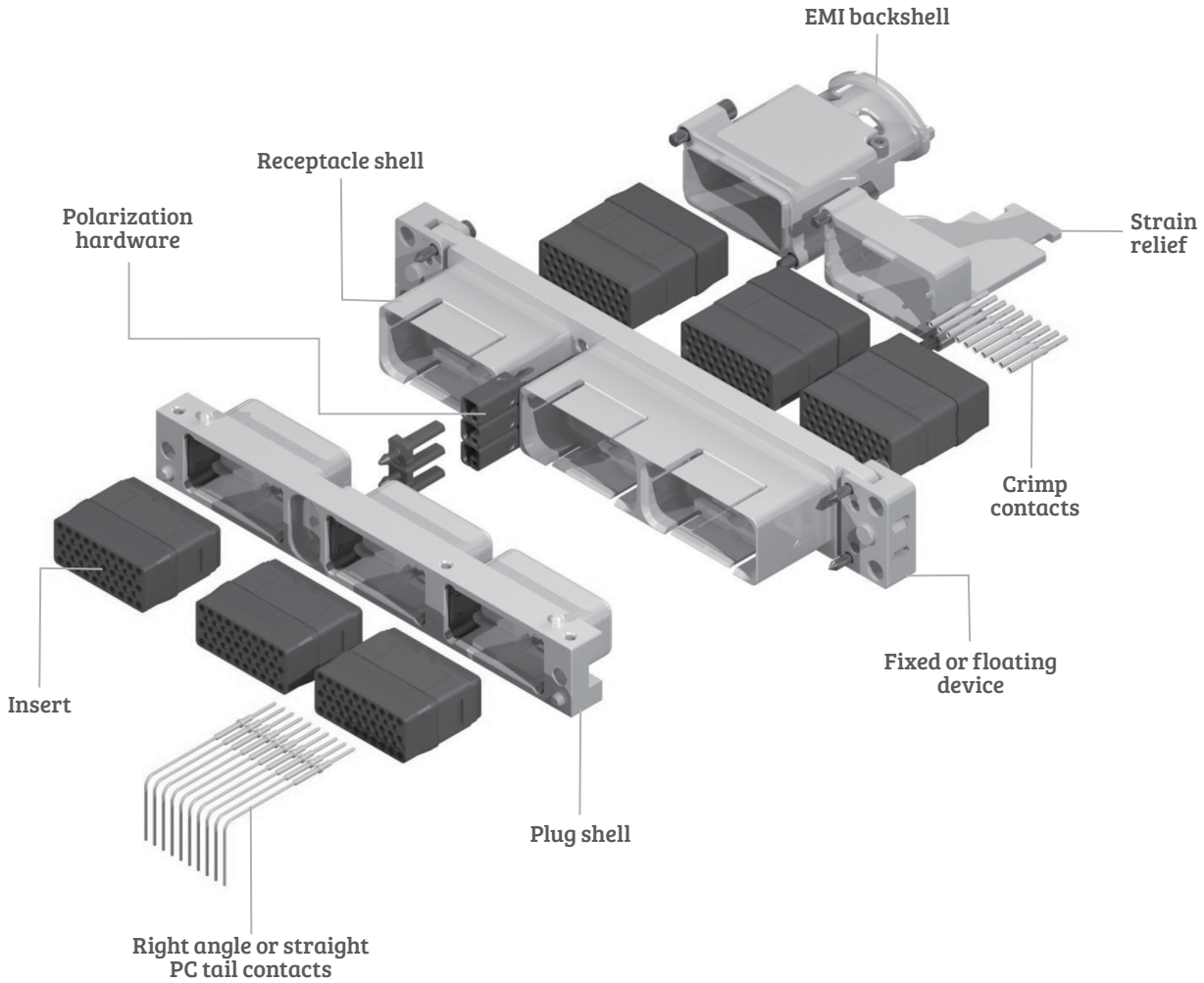

EPX® SERIES

INSERTS

CONTACTS

DISCONNECT APPLICATION

RACK & PANEL APPLICATION

How to Order EPXB1, B2, B3 & B4 Shell for LRM



Series prefix

Shell size

- B1:** One cavity shell
- B2:** Two cavity shell
- B3:** Three cavity shell
- B4:** Four cavity shell

Shell style

- P:** Plug, nickel-plated
- R:** Receptacle, nickel-plated

Shell mounting (refer to page 1-52 for coding)

- M:** Plug, fixed connector with Ø3.96mm holes & 4-40UNC on side
- N:** Plug, fixed connector with 8-32 UNC & 4-40UNC on side
- S:** Receptacle, fixed with 4 x 8-32UNC
- T:** Receptacle, floating with 4 x 8-32 UNC (two axes)⁽¹⁾

Polarization code

- 1:** Shell delivered with polarizing hardware unassembled
- 2:** Shell delivered with no polarizing hardware

Panel cut out coding

- A to Z:** Receptacle, refer to page 1-54 for the code selection
- 0 (zero):** Plug, no panel cut out coding

NOTE:

(1) This floating option is not available in EPXB4 version

How to Order EPXB1, EPXB2, B3 & B4 Assembly Kit for LRM

Assembly kit includes shell with inserts mounted, with or without contacts. When selecting your insert codes, do not forget to place them in the order you want them assembled. Polarization hardware are always provided unassembled with assembly kits.

Tips to help you make a selection:

- You are free to use either pin or socket inserts in EPXB plug or receptacle
 - Crimp contacts can be delivered with a kit, check which contacts will be included on page 1-10
 - If PC tail contacts are selected then all cavities including signal, power and quadrax are populated (Size 5 coax cavities are not populated)
 - If PC tail contacts are needed, remember that they are only available in plugs
- All connector inserts will use the same insert class and the same contact termination.

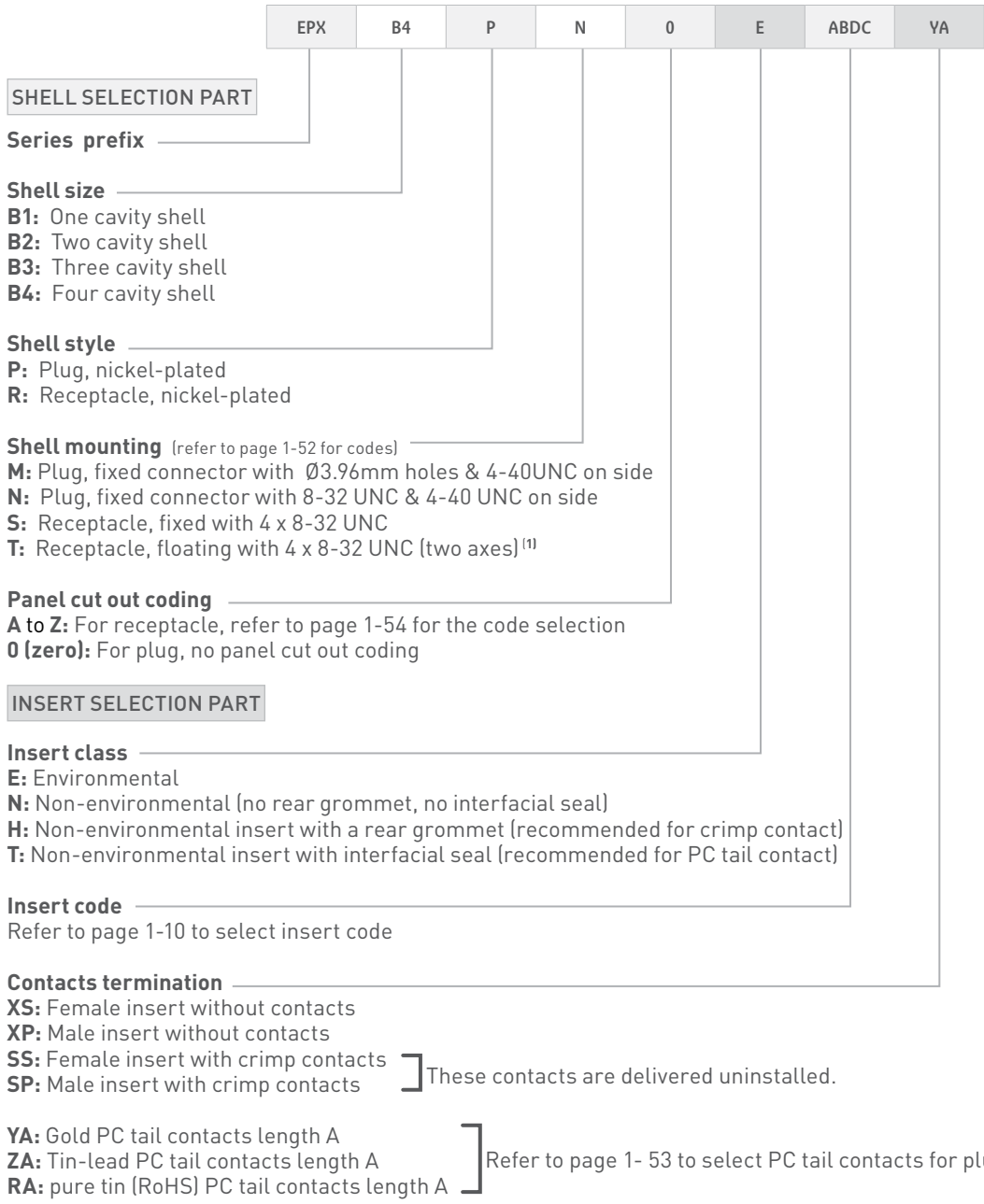

NOTE:

(1) This floating option is not available in EPXB4 version

Shell Mounting

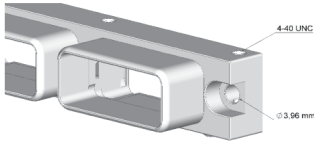
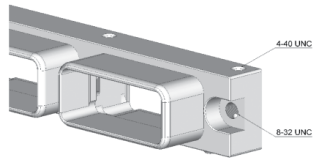
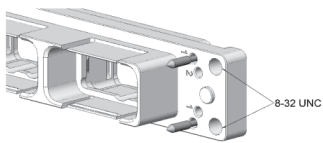
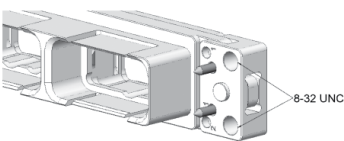
Receptacle side	Code	Plug side
N/A	M	Fixed connector with Ø 3.96 mm holes & 4-40 UNC front or side mount 
N/A	N	Connector with 8-32 UNC & 4-40 UNC front or side mount 
Fixed with 4 x 8-32 UNC panel rear mount 	S	N/A
Floating with 4 x 8-32 UNC panel rear mount 	T	N/A

EPXB Polarization Code

Polarization device is included in the part number and could be installed as shown below. Each shell has 3 polarization hardware which can be in four different position. The three polarization hardware can have their own position which allow a large range of codification.

Plug size 3
Polarization post

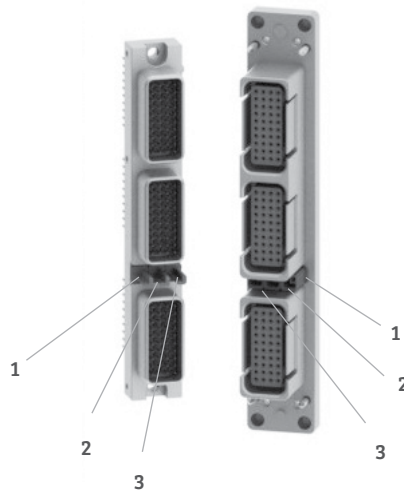

Receptacle size 3
Polarization key



Connectors are shown front side with cavity A upwards.

Contact Terminations for EPXB1, EPXB2, EPXB3 and EPXB4 Plugs

Straight PC Tail contact termination				
Mini Length E mm (inch)	Mini Length H mm (inch)	Gold	Tin-lead	Pure tin (RoHS)
10.60 [0.417] ⁽¹⁾	/	YA	ZA	RA
13.80 [0.543] ⁽¹⁾	/	YB	ZB	RB
15.60 [0.614] ⁽¹⁾	/	YC	ZC	RC
19.55 [0.769]	5.40 [0.212]	YD	ZD	RD

Right Angle PC Tail contact termination				
Mini length F mm (inch)	Mini length E mm (inch)	Gold	Tin-lead	Pure tin (RoHS)
2.20 [0.086]	12.85 [0.505] ⁽¹⁾	GA	LA	TA
3.60 [0.141]	20.10 [0.791]	GB	LB	TB
3.60 [0.141]	12.85 [0.505] ⁽¹⁾	GC	LC	TC
2.20 [0.141]	20.10 [0.791]	GD	LD	TD

NOTES:

(1) These PC tail lengths are not compatible with EPXBE and EPXBH inserts

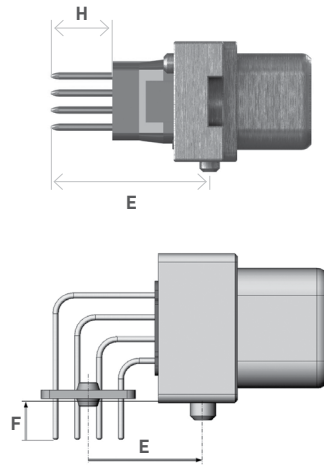

EPX® SERIES

INSERTS

CONTACTS

DISCONNECT APPLICATION

RACK & PANEL APPLICATION

EPXB Panel Cut out Coding

When several connectors are used with the same equipment, a coding is available on the shell to correlate the correct shell with the correct panel cut-out.

On the panel cut out, four areas are coded, area 1, 2, 3 and 4 (see figure below). For each area, one of the two holes should be drilled (hole n°1 or hole n°2). Each hole on the panel cut out corresponds to the use of a coding pin on the shell.

Panel cut-out coding	Panel hole number to drill in Area 1	Panel hole number to drill in Area 2	Panel hole number to drill in Area 3	Panel hole number to drill in Area 4
A	Connector delivered with coding device uninstalled			
B	1	1	1	1
C	1	1	1	2
D	1	1	2	1
E	1	1	2	2
F	1	2	1	1
G	1	2	1	2
H	1	2	2	1
J	1	2	2	2
K	2	1	1	1
L	2	1	1	2
M	2	1	2	1
N	2	1	2	2
P	2	2	1	1
R	2	2	1	2
S	2	2	2	1
T	2	2	2	2
Z	Connector delivered without coding pin ⁽¹⁾			

CODING PINS ARE FOR RECEPTACLE ONLY

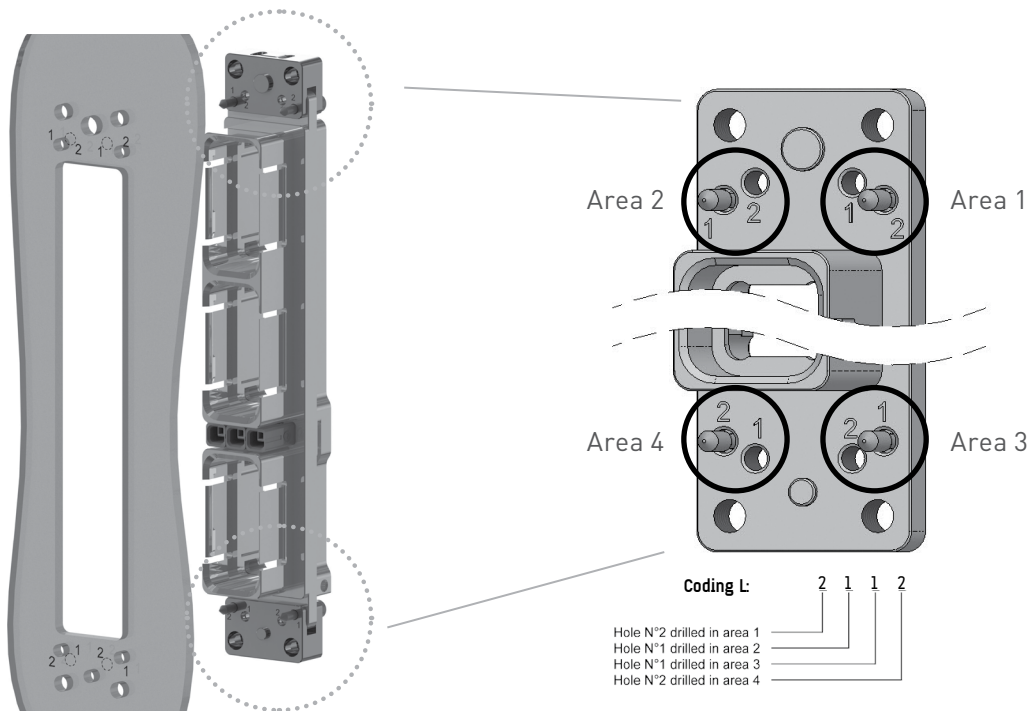

NOTE:
(1) Z panel cut out coding is only available with fix mounting

EPXB1 Shell Dimensions & Panel Cut outs

RECEPTACLE

Floating Mount

Fixed Mount

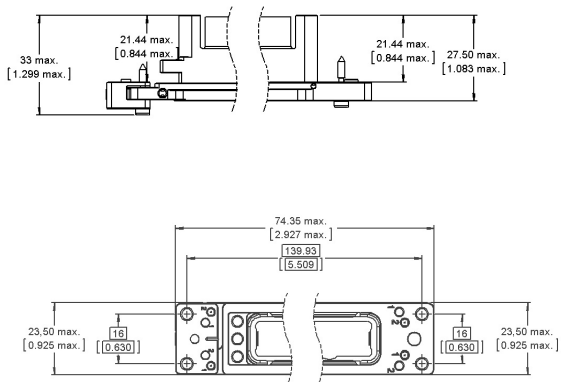

PLUG

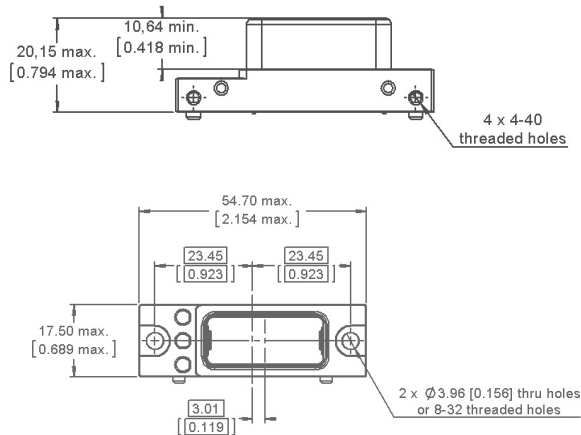

PANEL CUT OUTS

Receptacle

shown from the rear side

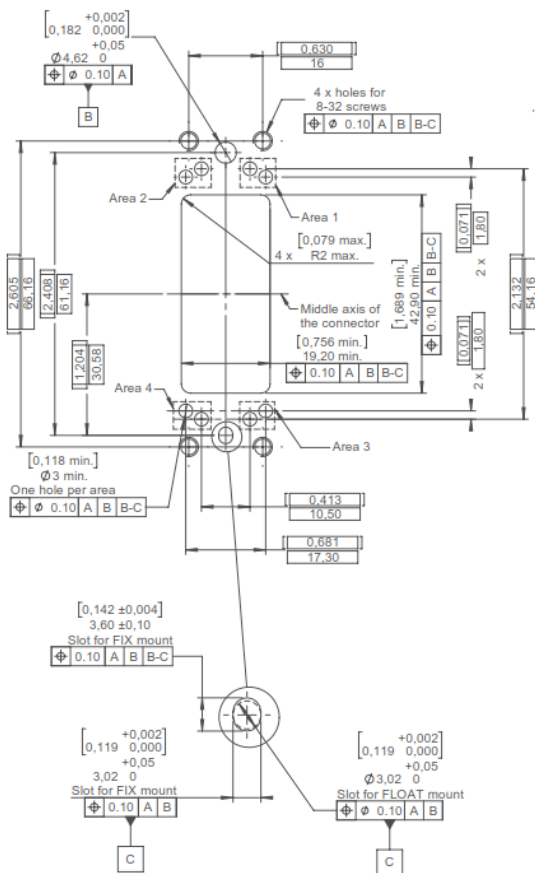

Plug

shown from the front side

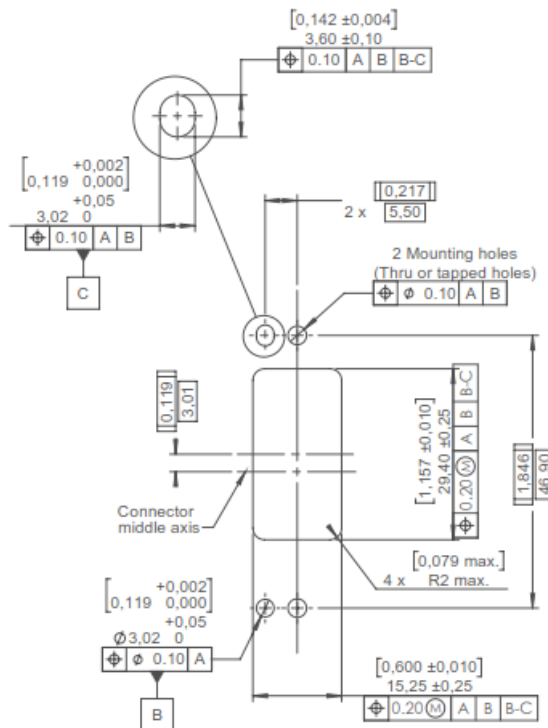

EPX® SERIES

INSERTS

CONTACTS

DISCONNECT APPLICATION

RACK & PANEL APPLICATION

EPXB2 Shell Dimensions & Panel Cut outs

RECEPTACLE

Floating Mount

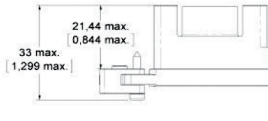

Fixed Mount

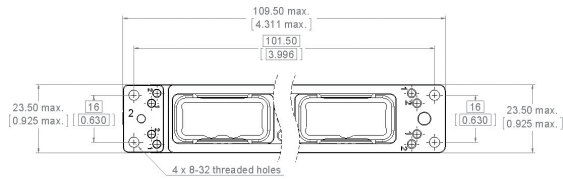
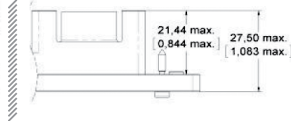

PLUG

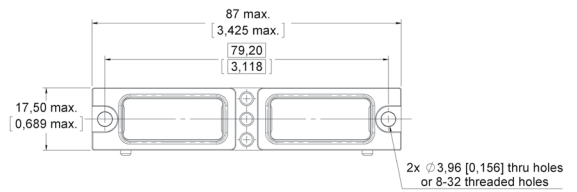
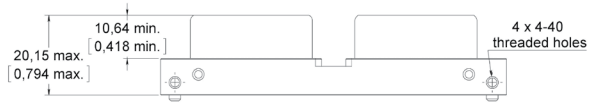

PANEL CUT OUTS

Receptacle

shown from the rear side

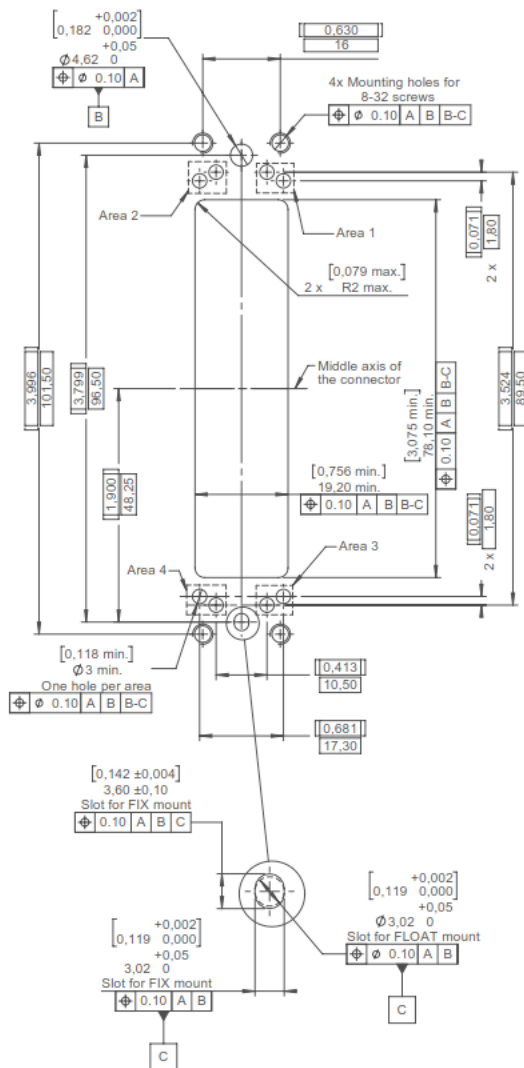

Plug

shown from the front side

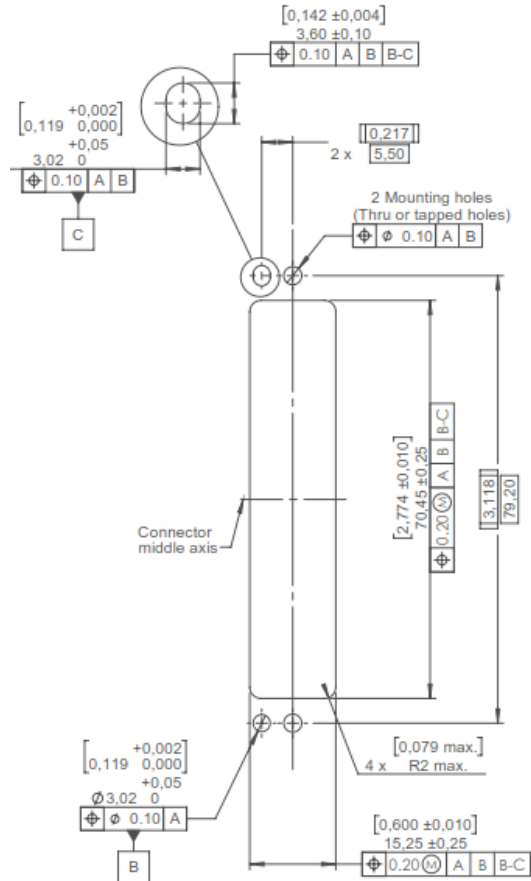

EPXB3 Shell Dimensions & Panel Cut outs

RECEPTACLE

Floating Mount

Fixed Mount

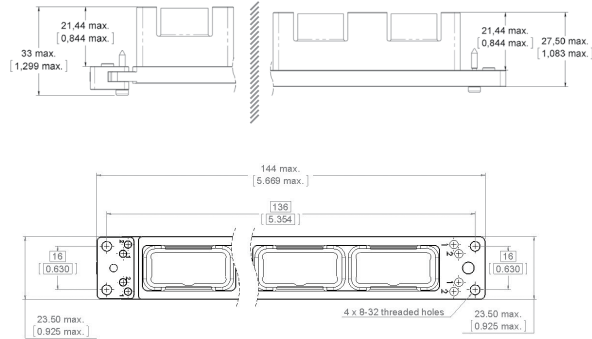

PLUG

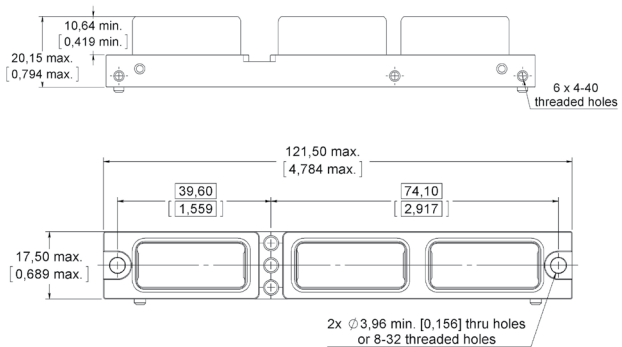

PANEL CUT OUTS

Receptacle

shown from the rear side

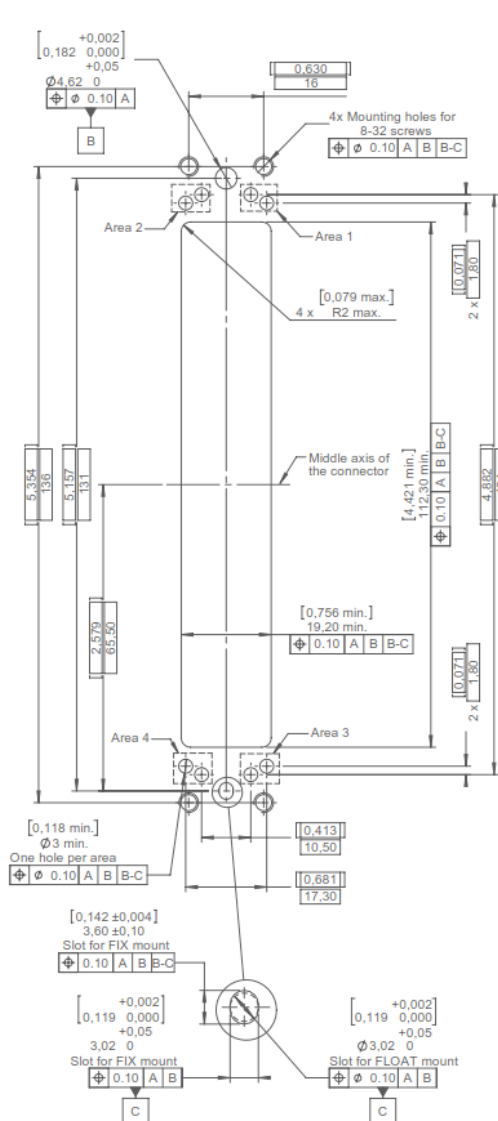

Plug

shown from the front side

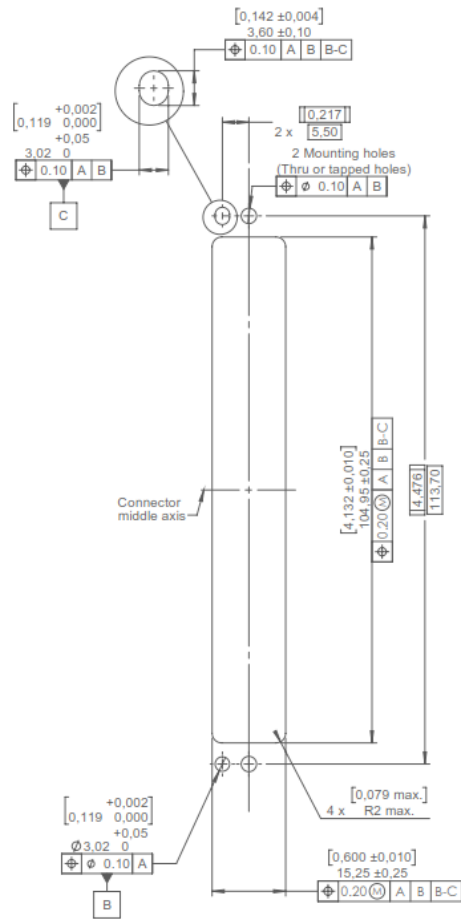

EPXB4 Shell Dimensions & Panel Cut outs

RECEPTACLE

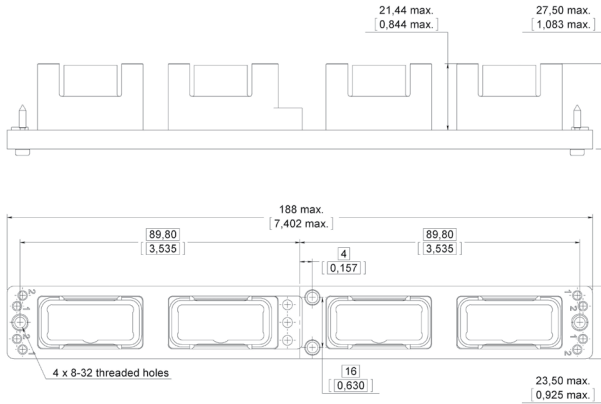

PLUG

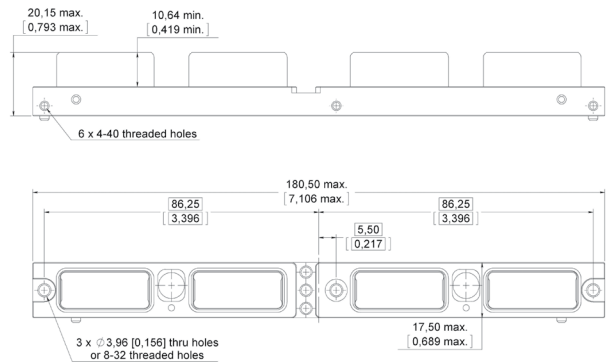

PANEL CUT OUTS

Receptacle

shown from the rear side

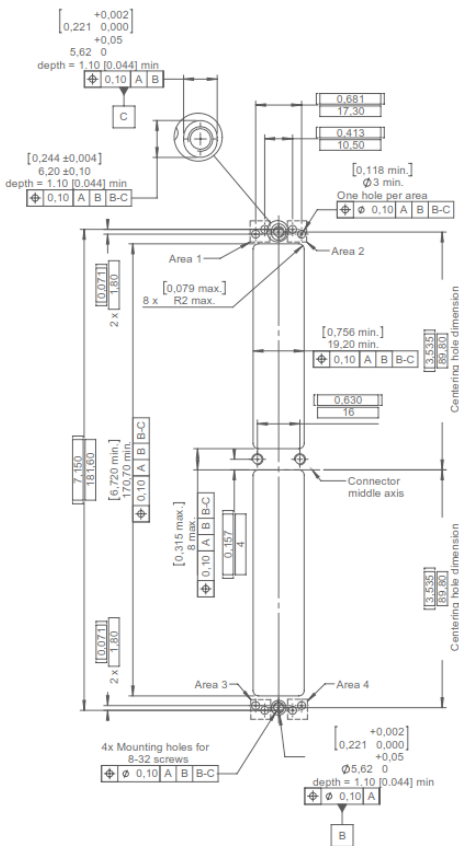

Plug

shown from the front side

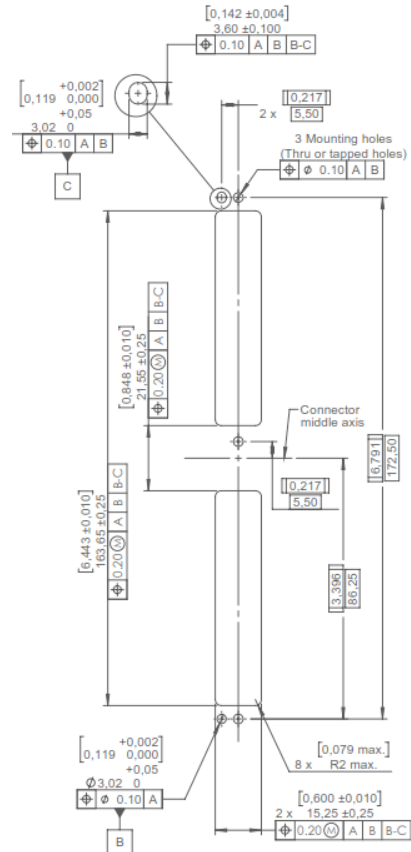

Rack & Panel Accessories

	Part number	Description
	617925073	EMI backshell for receptacle only (aluminium nickel-plated)
	617922022	Straight strain relief for receptacle only (composite)
	617954002	Dust cap for plug shell (pink color)
	617954003	Dust cap for receptacle shell (pink color)
	617954004	ESD dust cap plug shell (black color)
	617954005	ESD dust cap receptacle shell (black color)
	617980052	Coding Pin
	617980030	Polarization post
	617980031	Polarization key



INSERTS

CONTACTS

DISCONNECT APPLICATION

RACK & PANEL APPLICATION

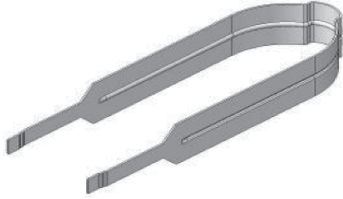
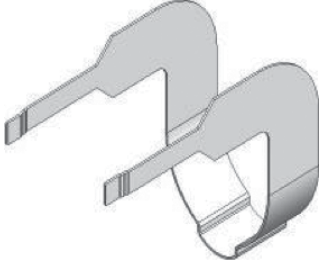
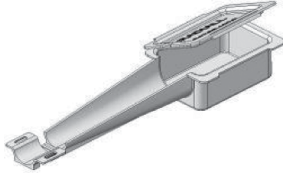
Rack & Panel Tools

	Part number	Description
	282521002	Insert extraction tool
	282521004	Right angle insert extraction tool
	617954020	Plastic box to protect wired inserts during handling
	F780855000	Hexagonal key 2mm [5/64inch] Flats for sleeve holder removal

EPXB2 for LRU Product Overview

Detailed view of a receptacle and plug for the EPXB2 LRU connector.

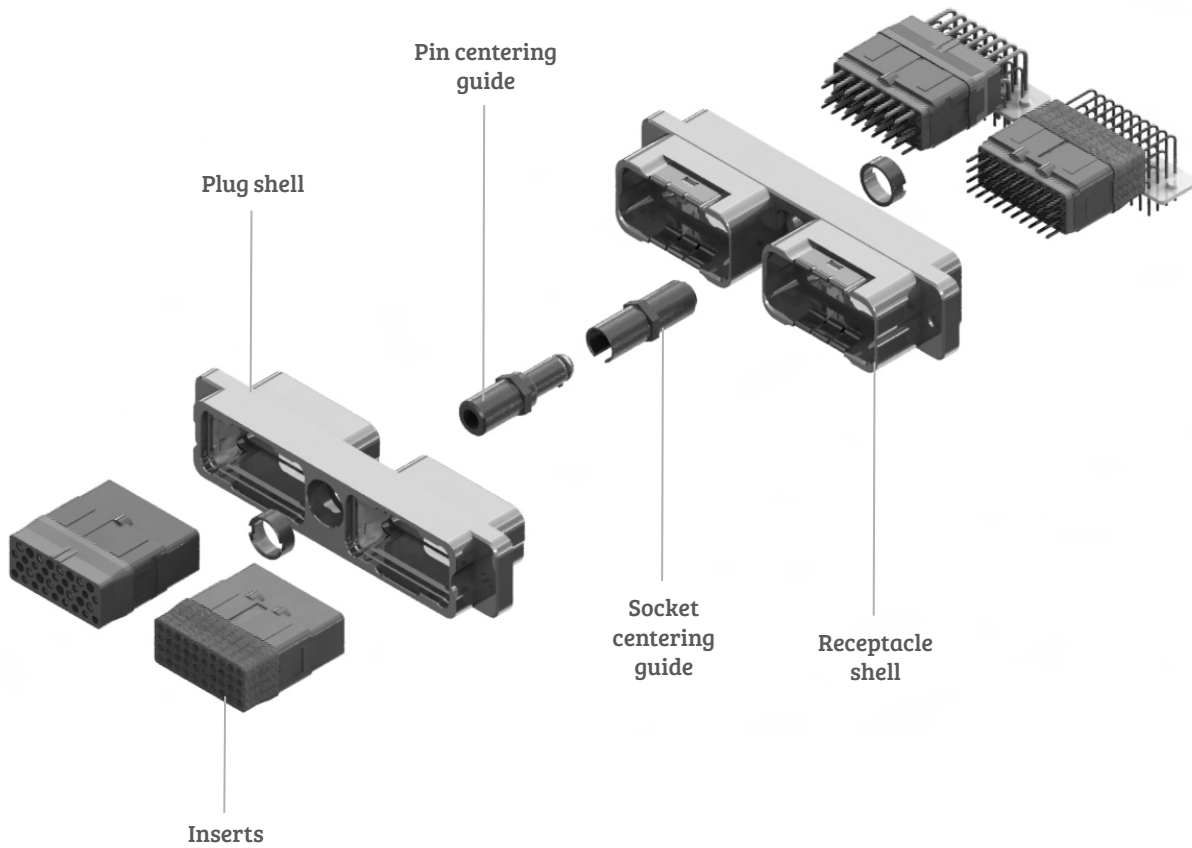

EPX® SERIES

INSERTS

CONTACTS

DISCONNECT APPLICATION

RACK & PANEL APPLICATION

How to Order EPXB2 Shell for LRU

	EPX	B2	H	L	2	2	N
Series prefix							
Shell size B2: Two cavity shell							
Shell style For option compatibility, see the table below L: Receptacle with flange H: Classic receptacle Z: Receptacle with ground block R: Receptacle without ground fingers C: iEPX receptacle with integrated strain-relief P: Classic plug W: Plug with ground block D: iEPX plug with integrated strain-relief							
Shell mounting A: Panel rear mounted connector with 4 x 6-32 mounting holes B: No mounting holes D: Connector with 2 x Ø3.10 mm thru holes F: Panel rear mounted connector with 2 x 6-32 mounting holes L: Panel rear mounted connector with 2 x 4-40 mounting holes							
Locking & polarization device⁽¹⁾ 4: Pin centering guide 5: Socket centering guide							
Polarization code 2: Polarizing device A to F delivered unassembled 3: Polarizing device N to Z delivered unassembled							
Shell class N: Nickel-plated aluminium M: Nickel-plated composite J: Nickel-plated weight optimized aluminium							

AVAILABLE SHELL MOUNTING

	Shell style	A (4 x 6.32 UNC)	B (no holes)	D (2 x Ø3.10mm)	F (2 x 6.32 UNC)	L (2 x 4.40 UNC)
Class N	L			x	x	x
	H		x	x	x	x
	Z	x	x			
	R	x				
	P		x	x		x
	W	x	x			
Class J (weight optimized aluminium)	H					x
	C					x
	P		x			
Class M (composite)	D		x			
	L			x		x
	P		x	x		x

NOTES:

- (1) Pin/Socket centering guides can be mounted on either plug or receptacle shells. However, the standard options are:
- Pin centering guide for plug shells
 - Socket centering guide for receptacle shells

How to Order EPXB2 Assembly Kit for LRU

Assembly kits includes shell with inserts mounted, with or without contacts. When selecting your insert codes, do not forget to place them in the order you want them assembled. Locking device is delivered uninstalled.

Tips to help you make a selection:

- You are free to use either pin or socket inserts in EPXB plug or receptacle
- Crimp contacts can be delivered with a kit, check which contacts will be included on page 1-10
- PC tail contacts can also delivered with a kit. Remember that only straight pin PC tail contacts are available, and in receptacle only. iEPX (styles C and D) are not available with PC tails
- If PC tail contacts are selected then all cavities including signal, power and quadax are populated. Size 5 coax cavities are not populated

All connector inserts will use the same insert class and the same contact termination. EPX is not compatible with insert 3Q3 in environmental class.

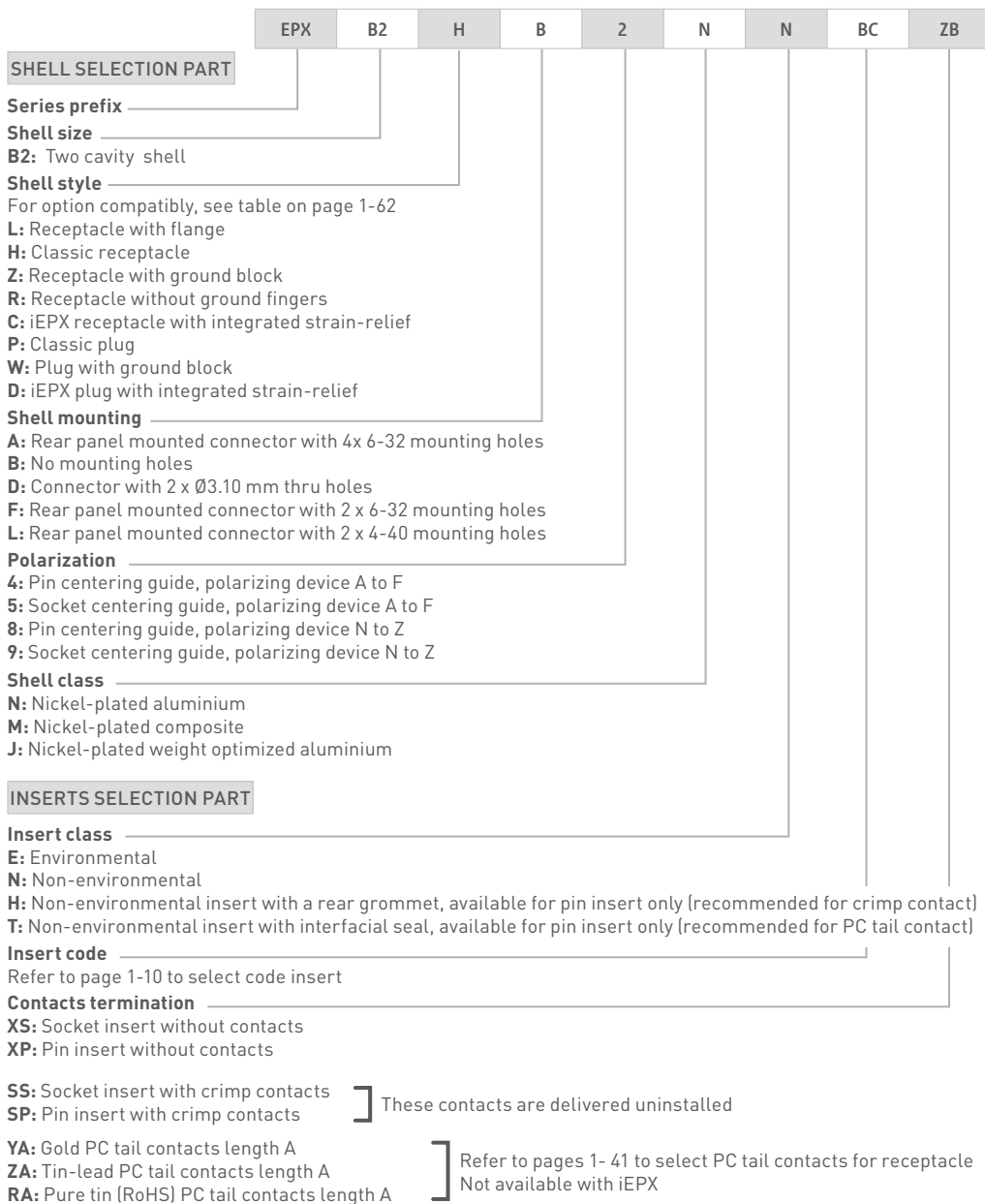

EPX® Galley Arinc 810 Product Overview

The EPXB2 Galley connector was specially designed for the severe conditions required by galley equipment. A floating mechanism was developed to avoid any risk of jamming and to guarantee a fully sealed connection.

The EPXB2 is used on ovens, beverage makers, refrigerators, microwave ovens and other equipment which fit within the new standardized galley layouts.

The EPXB2 connector is modular and provides extra contact density to add new contacts such as the #8 Twinax CAN data bus contact. Backshell accessories are also available.

Detailed view of receptacle and plug with accessories for the EPXB2 galley connector.

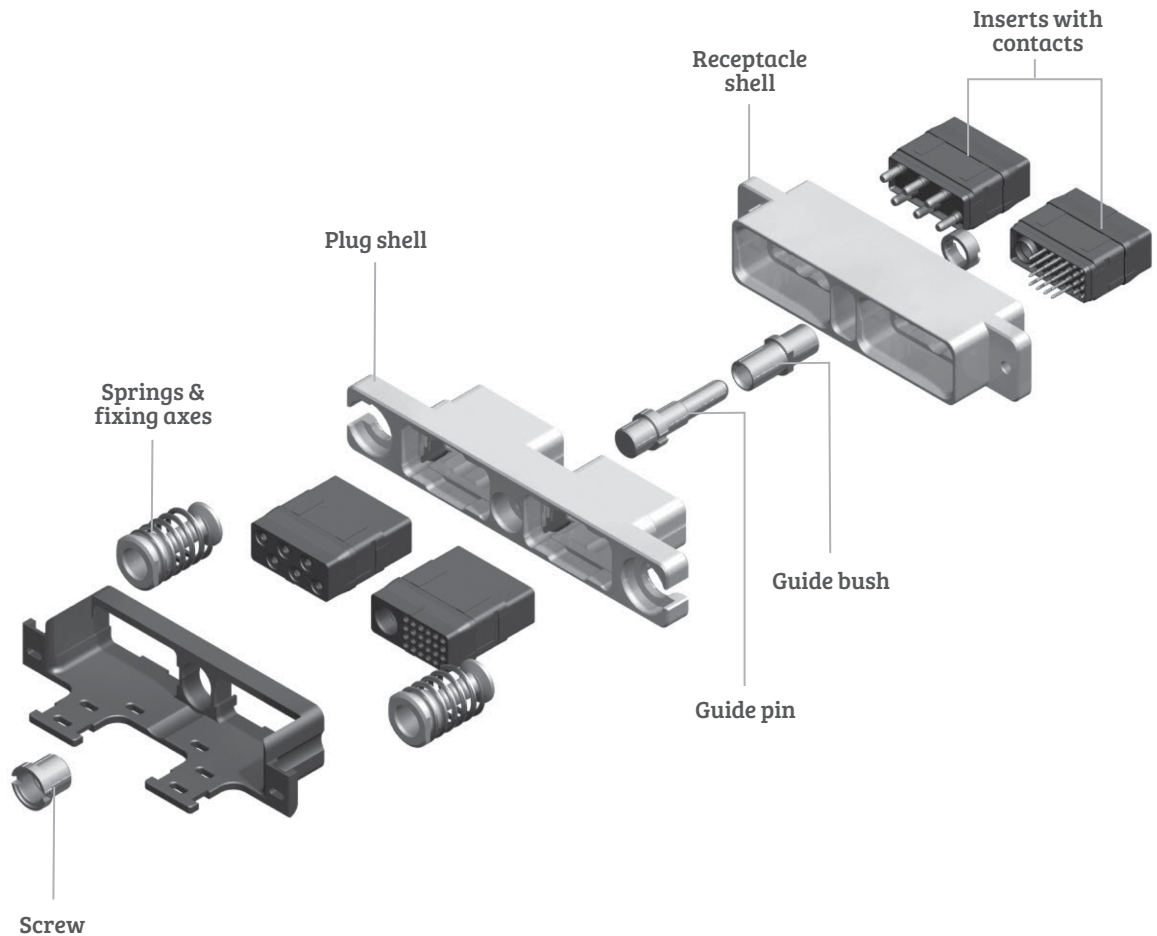

INSERTS

CONTACTS

DISCONNECT APPLICATION

RACK & PANEL APPLICATION

How to Order EPX® Galley Equipment Connector

RECEPTACLE AND PLUG ASSEMBLY KIT

Part number	Description
617610188 or 617610558	Receptacle assembled kit (*)
617610189	Plug assembled kit (*)

(*)Part numbers for assembly kits include: plug or receptacle shell, inserts, contacts, sealing plugs and dust caps.

Each item included in the kit is indicated in the table below and can also be ordered separately.

RECEPTACLE KITS

617610188

Shell with 2 self-locking threaded holes

Part number	Description	Quantity per kit
617610212	Receptacle shell	1
EPXBE25Q1PA	Insert for cavity A	1
EPXBE06PB	Insert for cavity B	1
617200	Pin crimp contacts/Size 22	15
617250	Pin crimp contacts/Size 12	6
616910	Filler plug	9
617954003	Dust cap	2

617610558

Shell with 2 thru holes

Part number	Description	Quantity per kit
617610419	Receptacle shell	1
EPXBE25Q1PA	Insert for cavity A	1
EPXBE06PB	Insert for cavity B	1
617200	Pin crimp contacts/Size 22	15
617250	Pin crimp contacts/Size 12	6
616910	Filler plug	9
617954003	Dust cap	2

PLUG KIT

617610189 contents

Part number	Description	Quantity per kit
617610213	Plug shell	1
EPXBE25Q1SA	Insert for cavity A	1
EPXBE06SB	Insert for cavity B	1
617300	Socket crimp contacts/Size 22	15
617350	Socket crimp contacts/Size 12	6
616910	Filler plug	9
617922007	Strain relief	1
617954002	Dust cap	2

CAN DATA BUS CONTACTS

Part number	Description
617165011	Size 8 Twinax pin contact
617065011	Size 8 Twinax pin contact

EPX® SERIES

INSERTS

CONTACTS

DISCONNECT APPLICATION

RACK & PANEL APPLICATION

Dimensions and Panel Cut Out

EPX® GALLEY EQUIPMENT CONNECTOR PER ARINC 810

RECEPTACLE

Front mount

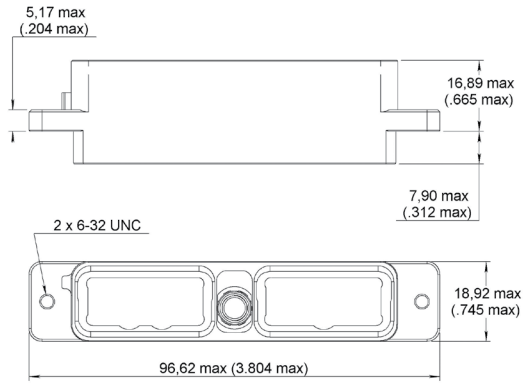

PLUG

Rear mount

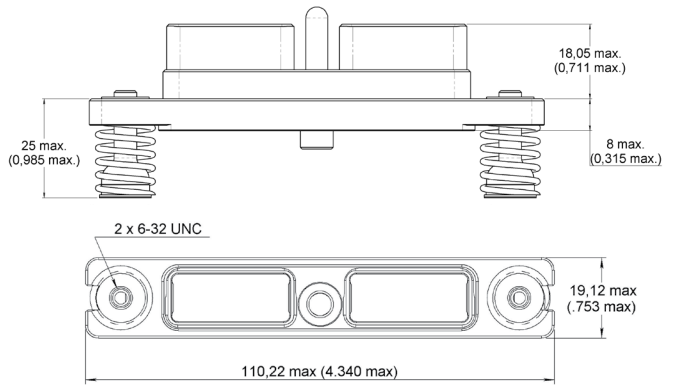

PANEL CUT OUT

RECEPTACLE

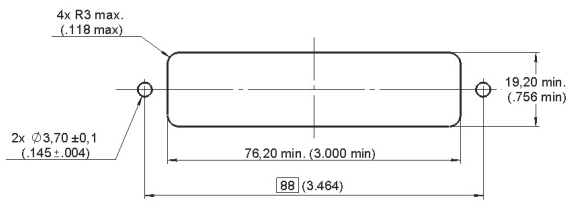

PLUG

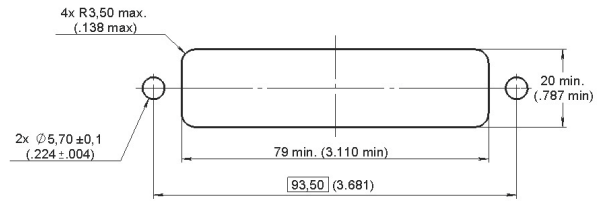

Multi-gang EPX® Connectors

A whole range of multigang connectors is available for disconnect and rack and panel applications. Multigang connectors features and benefits:

- Weight saving design
- Make installation easier and quicker
- Utilize EPX® modularity and its whole range of inserts
- Take advantage of EPX® connectors functionalities and use EPXB2 standard plug shells with a multigang shell

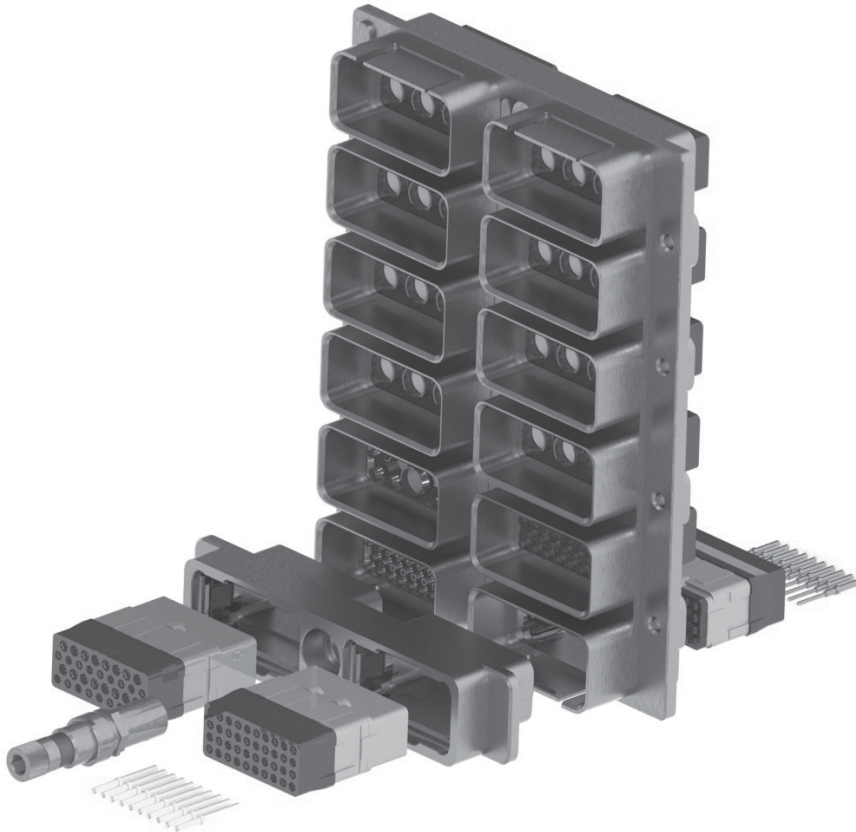

Specifications

- Several cavities for EPXB inserts: from 4 to 20 cavities
- Standard EPX strain reliefs and backshells available
- In accordance with EN4644 performance

Several options are available:

- Grounding block
- Grounding spring fingers
- Float mounting
- Spring loaded mounting

EPX® SERIES

INSERTS

CONTACTS

DISCONNECT APPLICATION

RACK & PANEL APPLICATION

SIMPLIFICATION is our INNOVATION

We advance the design and engineering process for innovators, ground-breakers and pioneers of technology. We reduce weight, improve durability, and streamline installation to provide leading-edge connectors that drive product performance.

AREA OFFICES LOCAL CONTACTS

EUROPE

ADDRESS	PHONE	FAX	EMAIL
FINLAND Radiall Finland PO Box 202, 90101, Oulu	+358407522412		infofi@radiall.com
FRANCE Radiall SA 25 Rue Madeleine Vionnet, 93300, Aubervilliers	+33149353535		info@radiall.com
GERMANY Radiall GmbH Carl-Zeiss-Straße 10, 63322, Rödermark	+49607491070	+496074910710	infode@radiall.com
ITALY Radiall Elettronica S.R.L. Via Zambelletti 19, 20021, Baranzate Milano	+39024885121	+390248843018	infoit@radiall.com
NETHERLANDS Radiall Nederland BV Hogebrinkerweg 15b, 3871, KM Hoevelaken	+31332534009	+31332534512	infofl@radiall.com
SWEDEN Radiall AB Sollentunavägen 63, 191 40 Sollentuna	+4684443410		infose@radiall.com
UNITED KINGDOM Radiall Ltd. Profile West, 950 Great West Rd., Brentford, Middlesex TW8 9ES	+441895425000	+441895425010	infouk@radiall.com

ASIA

CHINA Shanghai Radiall Electronics Co., Ltd. No.390, Yonghe Road, Shanghai, 200072	+862166523788	+862166521177	infozh@radiall.com
HONG KONG Radiall Electronics (Asia) Ltd. Room A, 16/F., Ford Glory Plaza, 37-39 Wing Hong Street, Cheung Sha Wan, Kowloon, Hong Kong	+85229593833	+85229592636	infohk@radiall.com
INDIA Radiall India Pvt. Ltd. 25D, Phase 2, Peenya Industrial Area, Bengaluru 560 058	+98028395271	+918028397228	infoin@radiall.com
JAPAN Nihon Radiall K.K. Sawada Building 8F, Shibuya-ku, Tokyo 150-0011	+0364274455	+0364274456	infojp@radiall.com

AMERICAS

USA & CANADA Radiall USA, Inc. 8950 South 52nd Street, Ste. 401 Tempe, AZ 85284	+14806829400	+14806829403	infousa@radiall.com
--	--------------	--------------	---------------------

GLOBAL PRESENCE

*Australia · Austria · Belgium · Brazil · Czech Republic · Denmark · Estonia · Greece · Hungary · Indonesia · Israel · Korea · Latvia · Lithuania
Malaysia · Norway · Philippines · Poland · Portugal · Russia · Singapore · Spain · Switzerland · Taiwan · Thailand · Vietnam · South Africa*

X-ON Electronics

Largest Supplier of Electrical and Electronic Components

Click to view similar products for [Rack & Panel Connectors](#) category:

Click to view products by [Radiall](#) manufacturer:

Other Similar products are found below :

[00170420102](#) [00171420202](#) [00171440002](#) [008026165000265](#) [00-8219-072-000-112P44](#) [008219072000112P5](#) [008219072000112P61](#) [00-8223-096-580-102](#) [02-014-013-5200-000](#) [00-8129-015-610-108](#) [613467-000](#) [CTJ112E01E-513](#) [CTJ116E03A-513](#) [M81714/63-22S L/C](#) [M81714/65-12-1](#) [66020-2](#) [CW8958-000](#) [699886-000](#) [D250-50632](#) [70.400.3240.0](#) [70.955.2453.3](#) [733753-000](#) [F22831-000](#) [780-522-DPX34RG8-02](#) [MMA25-0051R1](#) [MMA25-0341D1](#) [8660-501](#) [87.060.0053.0](#) [900709N001](#) [QRP4-12P-C\(01\)](#) [QR/P6-6S-C\(01\)](#) [AC-600003-004](#) [1218600-1](#) [D-659-0061](#) [DMC-MD 24 C-T](#) [1-445717-6](#) [1484398-2](#) [1484399-2](#) [1484469-2](#) [MR-34MG](#) [1484225-1](#) [1484398-1](#) [1484510-4](#) [1604997-2](#) [1663130-1](#) [1663767-7](#) [1663767-8](#) [MTC100-BF1-P31CS015](#) [MTC100-KT2-0083](#) [MTC100-KT2-0123-003](#)