

Contents

Introduction

LC, SC and ST Series	4-2
Markets and Applications	4-2
International Standard Documents Compliance	4-2

LC Series

Features and Benefits	4-3
LC Standard	4-4 to 4-5
LC for Harsh Environments	4-6
LC Adapters	4-7

SC Series

Features and Benefits	4-8
SC Standard	4-9 to 4-10
SC for Harsh Environments	4-11
SC Adapters	4-12

ST Series

Features and Benefits	4-13
ST Standard.....	4-14
ST Sealed Connection	4-15
ST for Harsh Environments	4-16
ST Receptacles	4-17
ST Adapters	4-17

Accessories for LC, SC and ST Series

Duplex Removable Clips	4-18
Inner Sleeves	4-18
Crimping Rings	4-19
Connector Caps	4-19
Boots	4-20 to 4-21

Connector Kit Configurators

LC Kit Configurator	4-22
SC Kit Configurator	4-23
ST Kit Configurator	4-23

Introduction

LC, SC AND ST SERIES

Radiall manufactures and offers a full range of LC, SC and ST connectors, adapters and accessories.

Each series is available in 2 versions to withstand the required environmental conditions:

- A standard range for indoor applications
- An ruggedized range specifically designed to perform with aerospace cables in harsh environmental conditions

MARKETS AND APPLICATIONS

Telecommunication

- Telecommunication networks, Fiber Channel for Storage Area Network (SAN), Local Area Networks (LAN), FTTH

Datacom

- Data converter, junction boxes, termination box, optical distribution frame

Broadcast

- Broadcast TV program, transport high speed data flow by computer through CATV

Medical

- Imaging devices, surgical instruments, sensors and equipment interconnects

Instrumentation

- Input/output of measurement boxes, optical sensors

Industrial

- Video surveillance, fiber optic sensor for industrial processes (measuring and control)

Military, Aerospace and Navy

- Environmental and structural sensors, data transmissions



Aerospace



Defense



Industrial



Telecom



Instrumentation



Medical



INTERNATIONAL STANDARD DOCUMENTS COMPLIANCE

- GR-326-CORE Telcordia specification
- IEC 61300 Fiber optic interconnecting devices and passive components
- RoHS compliant

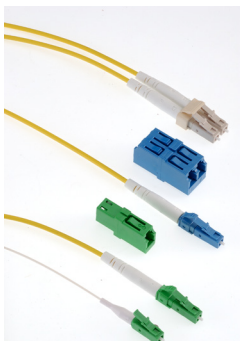

LC: IEC 61754-20

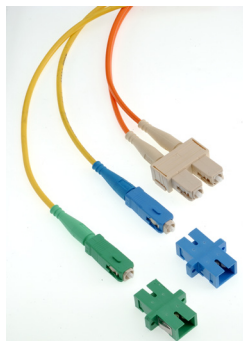

SC: IEC 61754-4



ST: IEC 61754-2

LC Series

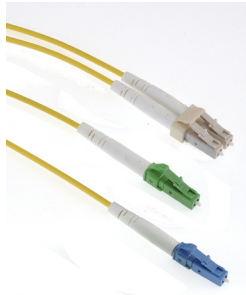

FEATURES AND BENEFITS

Easy Mounting and Installation

- Small Form Factor for high density applications (LC connector is half of the size of SC connector)
- Push-pull self latching system for quick insertion and extraction even on very dense circuitry
- Color coding for easy identification
- Proprietary secure bonding to protect the floating mechanism during the resin injection process.
- 8° pre-angled APC version is available to ease and speed up the installation in the field

High Performance

- High precision alignment with proven 1.25 mm zirconia ferrule
- APC polishing available (RL>65dB)
- Facilitates high speed applications with lower power requirements due to low Insertion loss (0.1 dB typical)

Secure Connection

- Spring loaded mechanism
- Pull-proof design with loose structure configuration to guarantee no optical disconnection when pulling on the cable.
- Radiall has improved the crimping reliability by using a small metallic tube to protect the fiber while reducing stress and ensuring excellent cable retention.

Versatile

- Adapted to MultiMode, SingleMode, PC, UPC and APC polishing
- Can be assembled in duplex configuration with a removable clip
- Two types available: standard and aerospace grade
- Various protection boots are available with exclusive shapes to tighten the cable and maintain high optical performance even when the cable is bent or pulled
- Connectors and adapters are manufactured under a worldwide license from OFS, formerly known as Lucent Technologies.

LC STANDARD CHARACTERISTICS AND PERFORMANCE

OPTICAL CHARACTERISTICS

	SingleMode UPC	SingleMode APC	MultiMode PC
Wavelength	1310 - 1550 nm		850 - 1300 nm
Insertion loss			
Mean	0.10 dB	0.15 dB	0.10 dB
Standard deviation	0.05 dB	0.10 dB	0.05 dB
Return loss	> 50 dB	> 65 dB	> 20 dB

Insertion Loss against a reference patchcord: IEC 61300-3-4 Method B

Return Loss: IEC 61300-3-6

MECHANICAL CHARACTERISTICS

	Cable Diameter 2 & 3 mm
Cable retention	68 N
Mechanical endurance	200 matings

ENVIRONMENTAL CHARACTERISTICS

Operating temperature	-40°C / +85°C
Storage temperature	-40°C / +85°C

MATERIALS

Molded plastic parts	V0 (UL 94)
Optical ferrule (connector)	Zirconia
Alignment sleeve (adapter)	Zirconia

LC Series



SIMPLEX LC CONNECTORS

The simplex connectors are supplied with straight boots, dust caps and crimping accessories, except for the “level 0” categories which enable users to configure their connectors according to their requirements.

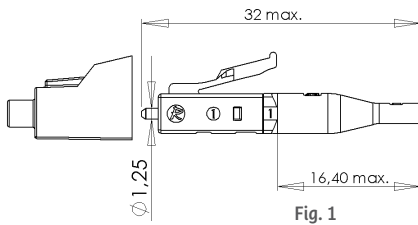

Fig. 1

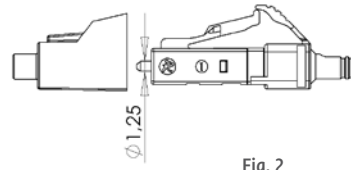
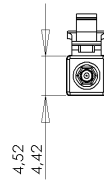

Fig. 2

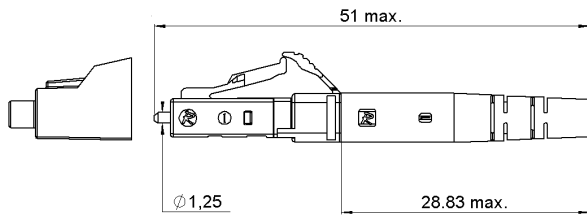
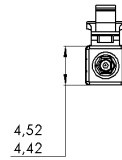

Fig. 3



Cable Diameter	Figure	SingleMode PC 126µm - Blue	SingleMode APC 126µm - Green	MultiMode PC 128µm - Beige	MultiMode PC 128µm - Aqua	Packaging
0.9 mm	Fig 1	F727 102 100	F727 152 100	F727 103 100	F727 103 110	100
Level "0" ⁽¹⁾ for 2 or 3 mm	Fig 2	F727 102 000	F727 152 000	F727 103 000	-	100
2 mm	Fig 3	F727 102 500	F727 152 500	F727 103 500	F727 103 510	100
3 mm		F727 102 700	F727 152 700	F727 103 700	F727 103 710	100

⁽¹⁾The level "0" is supplied without boots or crimp sleeves. To complete your connector assembly kit, please refer to the accessories chapter at the end of this section. Level "0" for 0.9 mm cable is available upon request.

Flexible configuration of simplex connector using level "0" part numbers

For 0.9 mm cable diameter

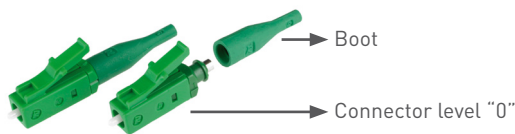

For 2 or 3 mm cable diameter

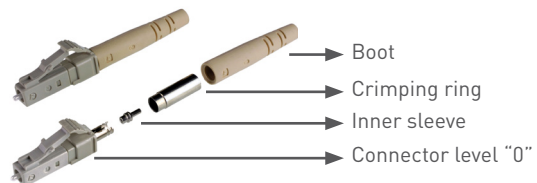

To get more information on how to find the corresponding part numbers and connector kit combination, please refer to the LC kit configurator section.

LC Series

APC 8° PRE-ANGLED SIMPLEX CONNECTORS

The APC version of the LC connector is also available in a pre-angled end face version for a fast polishing in the field and ultra-low back reflection.

Cable Diameter	Figure	SingleMode APC Pre-angled 126µm - Green	Packaging
0.9 mm		F727 132 100	100
2 mm		F727 132 500	100

DUPLEX LC CONNECTORS

Flexible Configuration with a Removable Duplex Clip:

Due to Radiall's LC removable duplex clip, a simplex connector can be changed into a duplex connector at any time. Select 2 Simplex LC connectors and a duplex removable clip to create your duplex LC connector. The duplex clip needs to be ordered separately. To select a clip, please refer to the accessories chapter at the end of this section.



Duplex LC with Non Removable Clip:

Radiall also provides "complete LC duplex" connectors. Being slightly smaller than the ones with the removable clip, they can be easily mounted into transceivers.



Cable Diameter	Figure	SingleMode PC 126µm - Blue	SingleMode APC 126µm - Green	MultiMode PC 128µm - Beige	Packaging
2 mm		F727 402 500	F727 452 500	F727 403 500	1
		F727 502 500	F727 552 500	F727 503 500	100
3 mm		F727 402 700	F727 452 700	F727 403 700	1
		-	-	F727 503 700	100

Note: Once assembled the brace is not removable.

LC Series

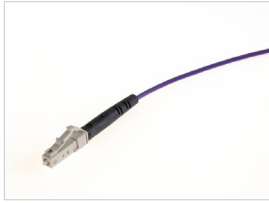

LC FOR HARSH ENVIRONMENTS

Radiall has enhanced the LC connectors to withstand harsh conditions for Mil/Aero applications.



Values shown in the tables below are minimum performances. If requested, Radiall can perform additional tests to demonstrate the performance of its ruggedized LC.

CHARACTERISTICS AND PERFORMANCES
OPTICAL CHARACTERISTICS

	SingleMode UPC	SingleMode APC	MultiMode PC
Wavelength	1300 - 1550 nm		850 - 1300 nm
Insertion loss	Mean	0.10 dB	0.10 dB
	Standard deviation	0.05 dB	0.05 dB
Return loss	> 50 dB	> 65 dB	> 20 dB

Insertion Loss against a reference patchcord: IEC 61300-3-4 Method B

Return loss: IEC 61300-3-6 (Maximum loss variation)

Note: the optical performances also depend on the fiber and/or cable construction.

MECHANICAL CHARACTERISTICS

	Cable Diameter: 1.8 – 2 mm
Cable retention	68 N
Mechanical endurance	500 matings
Vibration (EN 2591-403)	27.7 grms
Mechanical shocks (EN2591-402)	50 g, 11 ms

ENVIRONMENTAL CHARACTERISTICS

Operating temperature Thermal shocks (EN 2591-305)	-55°C / +125°C
Storage Temperature	-55°C / +125°C*

*Excludes cap and packaging

LC CONNECTORS

Cable diameter	Figure	SingleMode PC 126µm - Blue	SingleMode APC 126µm - Green	MultiMode PC 128µm - Beige	Packaging
1.8 - 2 mm Loose structure* Pull-proof design		F727 002 500Y	F727 052 500Y	F727 003 500Y	1
1.8 - 2 mm Tight structure* Non pull-proof design		F727 002 520Y	F727 052 520Y	F727 003 520Y	1

*See cable structure definitions in section 12, technical information, or in ARINC 802 specifications.

DUPLEX REMOVABLE CLIP

	Color	Part Number	Packaging	Picture
LC duplex removable clip	Beige	F718 197 006Y	1	

LC Series

LC ADAPTERS

Simplex Adapters

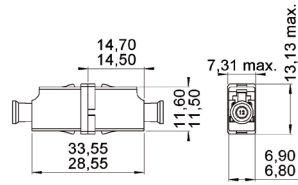

Fig. 1

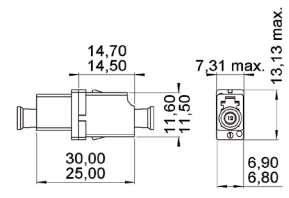

Fig. 2

Figure	SingleMode PC Blue	SingleMode APC Green	MultiMode PC Beige	MultiMode PC Aqua	Adapter Type	Alignment Sleeve	Packaging
Fig 1	F727 710 000	F727 710 100	F727 710 700	F727 710 710	LC cut-out Snap-in mounting	Zirconia	100
Fig 2	F727 711 000	F727 711 100	F727 711 700	F727 711 710			

Duplex Adapters

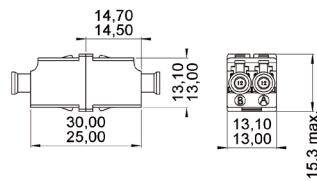

Fig. 1

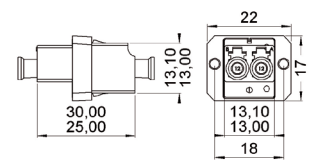

Fig. 2

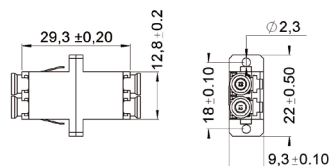

Fig. 3

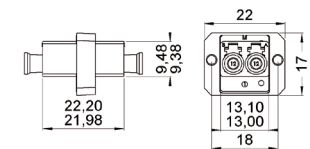

Fig. 4

Figure	SingleMode PC Blue	SingleMode APC Green	MultiMode PC Beige	MultiMode PC Aqua	Adapter Type	Alignment Sleeve	Packaging
Fig 1	F727 750 000	F727 750 100	F727 750 700	-	RJ-45 cut-out Snap-in mounting	Zirconia	100
	-	-	F727 750 800	-		PH/BR	100
Fig 2	F727 751 000	F727 751 100	F727 751 700	-	RJ-45 and low profile cut-out	Zirconia	100
Fig 3	F727 752 000	F727 752 100	-	F727 752 710	SC cut-out with panel clip	Zirconia	100
	-	-	F727 752 800	F727 752 810		PH/BR	100
Fig 4	F727 754 000	F727 754 100	F727 754 700	F727 754 710	SC RJ-45 cut-out with panel clip	Zirconia	100

SC Series



FEATURES AND BENEFITS

Easy Mounting and Installation

- Push-pull mechanism for fast and easy insertion and extraction
- 8° pre-angled APC version is available to ease and speed up the installation in the field
- Proprietary secure bonding to protect the floating mechanism during the resin injection process
- Color coding for easy identification

High Performance

- High precision alignment with proven 2.5 mm zirconia ferrule
- APC polishing available (RL>65dB)

Secure Connection

- Spring loaded mechanism
- Pull-proof design with loose structure configuration to guarantee no optical disconnection when pulling on the cable
- Radiall has improved the crimping reliability by using a mini metallic tube to protect the fiber, reduce stress and ensure an excellent cable retention

Versatile

- Adapted to MultiMode or SingleMode, PC, UPC and APC polishing.
- Available in duplex configurations by using a fully removable duplex brace.
- Various protection boots available with exclusive shapes to tighten the cable and maintain high optical performance even when the cable is bent or pulled.

SC STANDARD CHARACTERISTICS & PERFORMANCES
OPTICAL CHARACTERISTICS

	SingleMode PC	SingleMode APC	MultiMode PC
Wavelength	1310-1550 nm		850-1300 nm
Insertion Loss			
Mean	< 0.20 dB	< 0.20 dB	< 0.20 dB
Standard deviation	0.14 dB	0.15 dB	0.08 dB
Return Loss	> 50 dB	> 65 dB	20 dB

Insertion Loss against a reference patchcord: IEC 61300-3-4 Method B

Return Loss: IEC 61300-3-6

Note: The optical performances also depend on the fiber and/or cable construction.

MECHANICAL CHARACTERISTICS

	Cable Diameter 2 & 3 mm
Cable retention	100N
Mechanical endurance	200 matings

ENVIRONMENTAL CHARACTERISTICS

Operating temperature	-40°C / + 85°C
Storage temperature	-40°C / +85°C

MATERIALS

Molded plastic parts	V0 (UL 94)
Optical ferrule (connector)	Zirconia
Alignment sleeve (adapter)	Zirconia

SC Series

SIMPLEX SC CONNECTORS



The simplex SC connectors are delivered with straight boots, dust caps and crimping accessories, except for the level "0" categories which enable users to configure their own connectors according to their specific application.

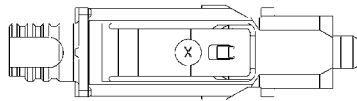

Fig. 1

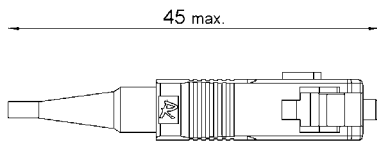
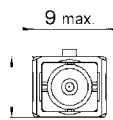

Fig. 2



7,4 max.

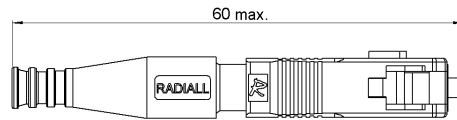
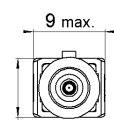
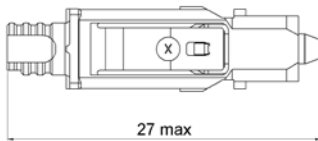

Fig. 3



7,4 max.

For APC applications, the ferrule extremity is conical to facilitate the angled polishing.



← Conical ferrule

Cable Diameter	Figure	SingleMode PC 126µm - Blue	SingleMode APC 126µm - Green	MultiMode PC 126µm - Beige	MultiMode PC 128µm - Aqua	Packaging
Level "0" ⁽¹⁾	Fig 1	F728 102 000	F728 112 000	F728 103 000	-	100
0.9 mm	Fig 2	F728 002 100	F728 012 100	F728 003 100	-	1
		F728 102 100	F728 112 100	F728 103 100	F728 103 101	100
2 mm	Fig 3	F728 002 500	F728 012 500	F728 003 500	-	1
		F728 102 500	F728 112 500	F728 103 500	F728 103 501	100
3 mm	Fig 3	F728 002 700	F728 012 700	F728 003 700	-	1
		F728 102 700	F728 112 700	F728 103 700	F728 103 702	100

⁽¹⁾The level "0" is supplied without boots or crimp sleeves. To complete your connector assembly kit, please refer to the accessories chapter at the end of this section.

Flexible configuration of simplex connector using level "0" Part Numbers

For 0.9 mm cable diameter

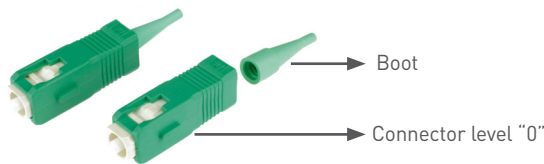

For 2 or 3 mm cable diameter

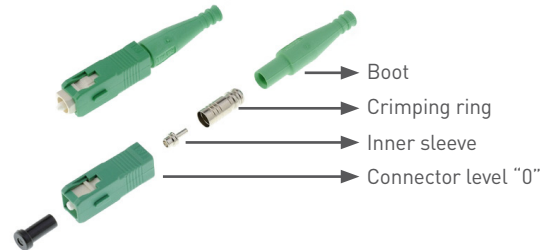

To get more information on how to find the corresponding part numbers and connector kit combination, please refer to the SC kit configurator section.

SC Series

APC 8° PRE-ANGLED SIMPLEX CONNECTORS



The APC version of the SC connector is also available in a pre-angled end face version for a fast polishing in the field and ultra-low back reflection.

Cable Diameter	Figure	SingleMode APC Pre-angled 126µm - Green	Packaging
0.9 mm		F728 132 100	100
3 mm		F728 132 700	100

DUPLEX SC CONNECTORS

With Radiall's SC removable duplex clip, a simplex connector can be changed into a duplex connector at any time. The clip is fixed after cabling. Select 2 Simplex SC connectors and a duplex removable clip to create your duplex SC connector. The identification of the optical channel (A or B) can be easily changed by reversing the clip cover.



To select a clip, please refer to the accessories chapter at the end of this section.

SC Series



SC FOR HARSH ENVIRONMENTS

Radiall has enhanced the SC connectors to withstand harsh conditions of Mil/Aero applications.



Values shown in the tables below are minimum performances. If requested, Radiall can perform additional tests to demonstrate the performance of its ruggedized SC.

CHARACTERISTICS AND PERFORMANCES

OPTICAL CHARACTERISTICS

	MultiMode PC
Wavelength	850-1300 nm
Insertion Loss	
Mean	< 0.20 dB
Standard deviation	0.08 dB
Return Loss	> 20 dB

Insertion Loss against a reference patchcord: IEC 61300-3-4 Method B

Return Loss: IEC 61300-3-6

Note: the optical performances also depend on the fiber and/or cable construction.

MECHANICAL CHARACTERISTICS

	Cable Diameter 1.8 - 2mm
Cable retention	68N
Mechanical endurance	200 matings

ENVIRONMENTAL CHARACTERISTICS

Operating temperature thermal shocks [EN 2591-305]	-55°C / +125°C
Storage Temperature	-55°C / +125°C*

*Excludes cap and packaging

SC CONNECTORS

Cable Diameter 1.8 - 2mm	Figure	MultiMode PC	Packaging
1.8 - 2 mm Loose structure* Pull-proof design		F728 003 500Y	1
1.8 - 2 mm Tight structure* Non pull-proof design		F728 003 520Y	1

*See cable structure definition in the glossary or in ARINC 802 specification.

For other cable diameters and SingleMode PC and APC configurations, please contact your local Radiall representative.

SC Series

SC ADAPTERS

SC adapters are available for snap-in or flange screw-in mounting. Color coding remains the same as the connector coding:

- SingleMode PC: Blue
- SingleMode APC: Green
- MultiMode PC: Beige
- MultiMode PC with OM3 fiber: Aqua

Simplex Adapters

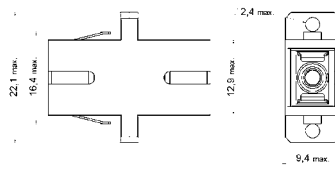

Fig. 1

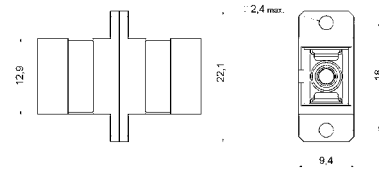

Fig. 2

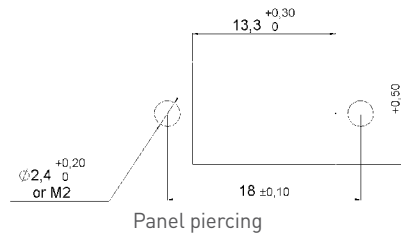

Figure	SingleMode PC Blue	SingleMode APC Green	MultiMode PC Beige	MultiMode PC Aqua	Alignment Sleeve	Adapter Type	Packaging
Fig 1	F728 703 000	F728 703 100	F728 703 700	-	Zirconia ceramic	Snap in	1
	F728 713 000	F728 713 100	F728 713 700	F728 713 701			100
Fig 2	F728 700 000	F728 700 100	F728 700 700	-	Zirconia ceramic	Screw in	1
	F728 710 000	F728 710 100	F728 710 700	-			100

Duplex Adapters

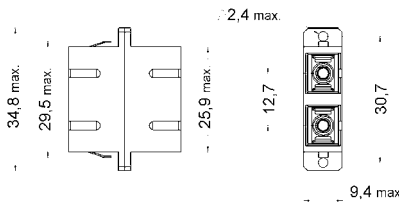

Fig. 1

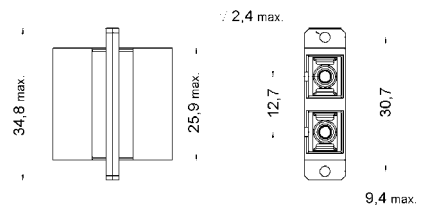

Fig. 2

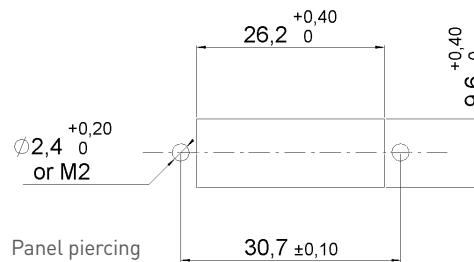

Figure	SingleMode PC Blue	SingleMode APC Green	MultiMode PC Beige	MultiMode PC Aqua	Alignment Sleeve	Adapter Type	Packaging
Fig 1	F728 743 000	F728 743 100	F728 743 700	-	Zirconia ceramic	Snap in	1
	F728 753 000	F728 753 100	F728 753 700	F728 753 701			100
Fig 2	F728 750 000	F728 750 100	F728 750 700	-	Zirconia ceramic	Screw in	100

ST Series



FEATURES AND BENEFITS

Secure Connection

- Bayonet locking system for a fast and easy setup
- Spring loaded mechanism
- ST's key prevents rotation of the ceramic ferrule
- Nickel-plated housing for a robust connection
- High precision alignment with 2.5 mm zirconia ceramic ferrule

Versatile

- Standard or secure crimping (double ferrule)
- Sealed version for use in humid or wet environment (IP64)
- ST connector available for harsh environment applications
- Available in MultiMode and SingleMode configurations
- Available for various fiber and cable diameters

ST STANDARD CHARACTERISTICS AND PERFORMANCES

OPTICAL CHARACTERISTICS

	SingleMode PC	MultiMode PC
Wavelength	1310-1550 nm	850 nm
Insertion loss		
Mean	< 0.25 dB	< 0.25 dB
Standard deviation	0.11 dB	0.11 dB
Return loss	> 50 dB	> 20 dB

Insertion Loss against a reference patchcord: IEC 61300-3-4 Method B

Return loss: IEC 61300-3-6

Note: The optical performances also depend on the fiber and/or cable construction.

MECHANICAL CHARACTERISTICS

	Cable Diameter 2 & 3 mm
Cable retention	100N
Mechanical endurance	500 matings

ENVIRONMENTAL CHARACTERISTICS

Operating temperature	-40°C / +85°C
Storage temperature	-40°C / +85°C

MATERIALS

Molded plastic parts	V1 (UL 94)
Body	Brass, nickel plated
Alignment sleeve (adapter)	Zirconia

ST Series



ST CONNECTORS

The ST connectors are delivered with straight black boots, dust caps and crimping accessories, except for the level "0" categories which enable users to build their own connectors according to their applications. The ST series also includes an enhanced version of the ST connector which features a secure crimping device and configuration specific for harsh environments.

The secure crimping device enables aramids strength members and the outer jacket of the fiber to be held together simultaneously and allow for reliable protection of the fiber against the crimping stress.

Standard crimping

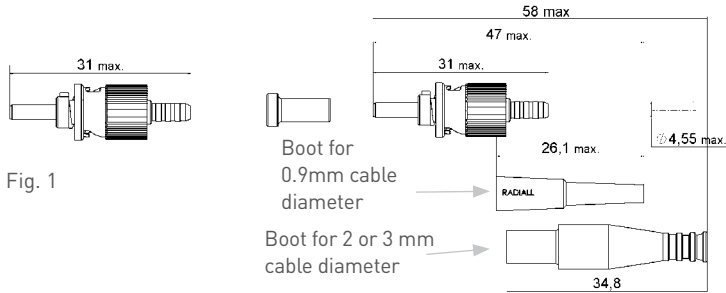

Fig. 1

Fig. 2

Secure crimping

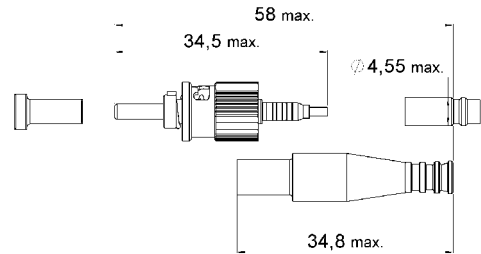

Fig. 3

Cable diameter	Figure	Standard Crimping			Secure Crimping		Packaging
		SingleMode PC 126µm	MultiMode PC 128µm	MultiMode PC 140µm	SingleMode PC 126µm	MultiMode PC 128µm	
Level "0" ⁽¹⁾	Fig 1	F709 036 200	F709 025 200	-	-	-	100
0.9 mm	Fig 2	F709 034 706 ⁽²⁾	F709 022 000	F709 090 000 ⁽²⁾	-	-	1
		F709 034 200 ⁽²⁾	F709 022 200	-	-	-	100
2 mm	and	-	-	-	-	F709 097 200	100
3 mm	Fig 3	F709 034 706 ⁽²⁾	F709 024 000 ⁽²⁾	F709 090 000 ⁽²⁾	-	-	1
		F709 034 200 ⁽²⁾	F709 024 200 ⁽²⁾	-	F709 096 200	F709 098 200	100

⁽¹⁾The level "0" is supplied without boots or crimp sleeves. To complete your connector assembly kit, please refer to the accessories section.

⁽²⁾2 Boots are delivered with this PN
For other cable diameters, please contact your local Radiall representative.

Flexible Configuration Using Level "0" Part Numbers:

For 0.9 mm cable diameter

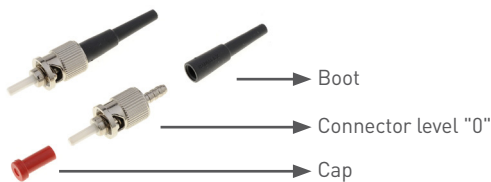

For 2 or 3 mm cable diameter

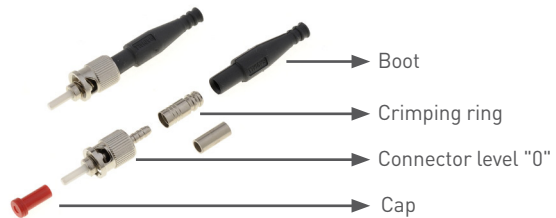

To get more information on how to find the corresponding part numbers and connector kit combination, please refer to the ST kit configurator at the end of this section.

ST Series



ST SEALED CONNECTION

Radiall also offers an ST connector with a specific design which ensures a reliable connection even in wet environments.

By combining the sealed connector and adapter, you'll get a fully sealed IP64 connection for operations in all climatic conditions (rain, snow, etc., except immersion).

FEATURES AND BENEFITS

Secure crimping

Effective protection in wet environment

Bayonet locking system

Pre-radius MultiMode zirconia ceramic ferrule

Outside boot providing the sealing of the complete connection, IP64

By adding an internal gasket on the bulkhead adapter and an outside boot, the sealing is guaranteed on 3 points of the connection:

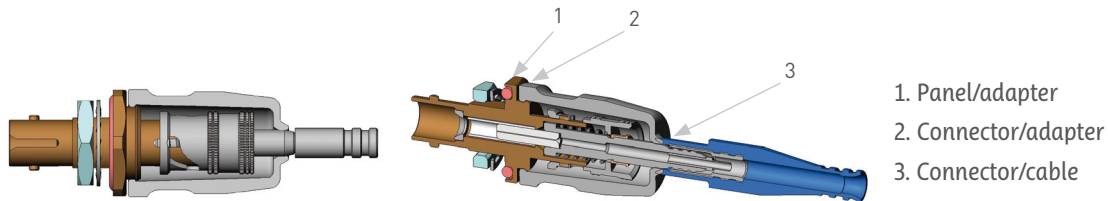

HOW TO ORDER

ST Sealed Connectors

	Figure	MultiMode PC 128µm	Cable dia.	Packaging
		F709 089 000	2.7 mm to 3 mm	1

ST Sealed Adapter

The sealed adapter has been designed to be used with the sealed connector F709 089 000 to guarantee a completely sealed connection.

	Figure	Part Number	Alignment sleeve	Packaging
		F709 724 000	Zirconia ceramic	1

Note: the sealed connector and adapter cannot be combined with non-sealed versions.

ST Series



ST FOR HARSH ENVIRONMENTS

The ruggedized ST is a IEC 61754-2 type connector dedicated to Mil/Aero applications with a bayonet locking system. This ST configuration is also available for tight structure cables specific for Mil/Aero applications.



CHARACTERISTICS AND PERFORMANCES

	MultiMode PC	
Wavelength	850-1300 nm	
Insertion Loss	Mean	0.25 dB
	Standard deviation	0.08 dB
Return Loss	> 20 dB	

Insertion Loss against a reference patchcord: IEC 61300-3-4 method B

Return loss: IEC 61300-3-6 (Maximum loss variation)

Note: the optical performances also depend on the fiber and/or cable construction.

MECHANICAL CHARACTERISTICS

	Cable Diameter: 1.8 max.
Cable retention	100N
Mechanical endurance	500 matings

ENVIRONMENTAL CHARACTERISTICS

Operating temperature thermal shocks (EN 2591-305)	-55°C / +125°C
Storage temperature range	-55°C / +125°C*

*Excludes cap and packaging

HOW TO ORDER

Cable Diameter	Figure	MultiMode PC	Packaging
1.8 - 2 mm Loose structure* Pull-proof design		F709 020 100Y	1
1.8 - 2 mm Tight structure* Non pull-proof design		F709 150 000Y	1

*See cable structure definition in the glossary or in ARINC 802 specification.

ST Series

ST RECEPTACLES

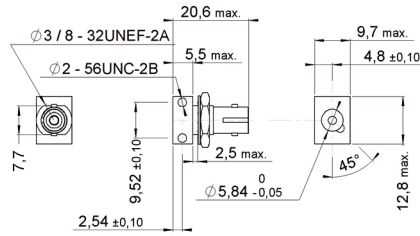

Fig. 1

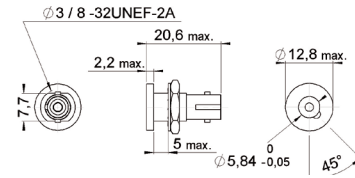
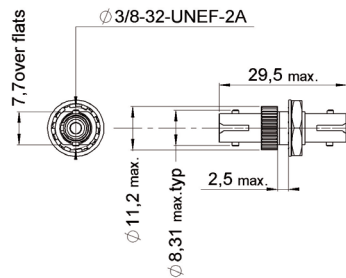

Fig. 2

Part Number	Figure	Description	Note	Panel Piercing	Packaging
F709 400 000	Fig 1	Bulkhead or PCB mounting	Metal body, supplied with 2 centering rings		1
F709 401 000	Fig 2	Bulkhead mounting			1

ST ADAPTERS

The ST adapter features a bayonet coupling system to secure the connection with the ST connectors. The alignment sleeve is available in zirconia ceramic or in phosphor bronze and works for SingleMode or MultiMode fibers.



Part Number	Alignment Sleeve	Panel Piercing	Packaging
F709 730 000	Zirconia ceramic		1
F709 730 200			100
F709 722 000	Phosphor bronze		1
F709 722 200			100

Accessories for LC, SC and ST Series

DUPLEX REMOVABLE CLIPS

Series	Figure	SingleMode APC - Green	SingleMode PC - Blue	MultiMode Beige	Black	Packaging
LC		F718 197 205	F718 197 201	F718 197 206	F718 197 200	100
SC		F718 102 000	F718 101 000	F718 100 000	-	

INNER SLEEVES

Series	Figure	Cable dia.	Part number	Packaging
LC		2 & 3 mm	F718 158 200	100
SC		1.6 mm to 3 mm	F718 106 200	

Accessories for LC, SC and ST Series

CRIMPING RINGS

Series	Figure	Cable Diameter	Part Number	Packaging
LC		2mm	F718 160 200	100
		2.4mm	F718 175 200	
		3mm	F718 170 200	
SC		2mm	F718 109 200	
		2.4mm	F718 108 200	
		3mm	F718 107 200	
ST		2mm	F718 146 200	
		2.4mm	F718 069 000	
		3mm	F 718 145 200	

CONNECTOR CAPS



Fig. 1



Fig. 2



Fig. 3



Fig. 4



Fig. 5

Picture	Description	Series	Part Number	Packaging
Fig. 1	Metal protective cap	ST adapters and receptacles	F709 760 000	1
Fig. 2	Safety plastic cap	ST connectors	F718 044 000	20
Fig. 3	Clipped plastic dust cap	LC connectors	F718 183 204	100
Fig. 4	Metal dust cap	ST connectors	F709 750 000	20
Fig. 5	Universal, plastic dust cap	SC, ST connectors and all connectors with 2.5 mm optical ferrule	F718 111 220	20

Accessories for LC, SC and ST Series

BOOTS

Radiall manufactures and offers a wide range of boots supporting multiple connector types. Different boots are available to protect the fiber while providing enough flexibility when handling the fiber cable.

LC SUPER FLEXIBLE BOOTS



Super flexible boots are specifically recommended when space is limited and when a small bending radius is required (min radius 20 mm). They prevent any damage to the fiber even in case of low bend radius. These boots are available in various colors.

Figure	Color	Flexible Boots	Cable Dia.	Packaging
	Black	F718 207 200	2 mm	100
	Blue	F718 207 201		
	Yellow	F718 207 202		
	Red	F718 207 203		
	White	F718 207 204		
	Green	F718 207 205		
	Aqua	F718 207 209		

Bending Radius Comparison

With its specific design, the super flexible boot can reduce the bending radius up to two times of a standard straight boot. They provide remarkably small bend radii with minimum losses.

Note: The bending radius is cable dependent.

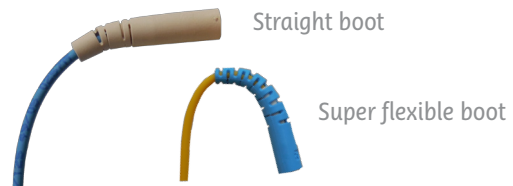

LC STRAIGHT BOOTS



Boots are available in various colors and dimensions depending on the requirements.

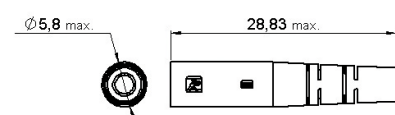

Fig. 1

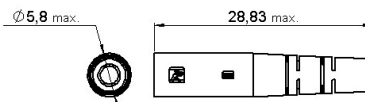

Fig. 2

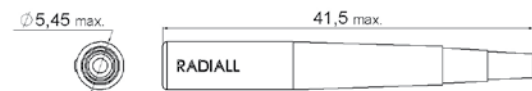
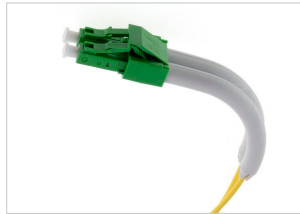

Fig. 3

Color	Cable Diameter				Packaging
	0.9 mm Fig 1	2 mm Fig 2	3 mm Fig 2	Universal boot for 2/3 mm Fig 3	
Black	F718 166 200	F718 162 200	F718 193 200	F718 169 200	100
Blue	F718 166 201	F718 162 201	F718 193 201	F718 169 201	
Yellow	F718 166 202	F718 162 202	-	F718 169 202	
Red	F718 166 203	F718 162 203	F718 193 203	F718 169 203	
White	F718 166 204	F718 162 204	F718 193 204	F718 169 204	
Green	F718 166 205	F718 162 205	F718 193 205	F718 169 205	
Beige	F718 166 206	F718 162 206	F718 193 206	F718 169 206	
Aqua	F718 166 209	F718 162 209	F718 193 209	-	

Accessories for LC, SC and ST Series

LC ANGLED BOOTS



Available in short and long versions, angled boots are rigid and specifically designed to adapt to limited access environments. They can be mounted in a stackable position when operating in dense circuitry. They can also be combined to be used in duplex configurations.

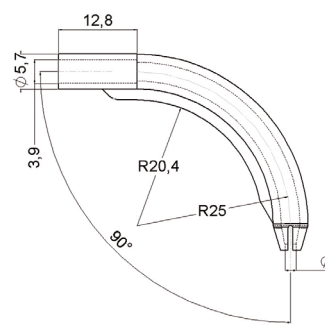
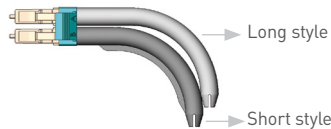

Fig. 1

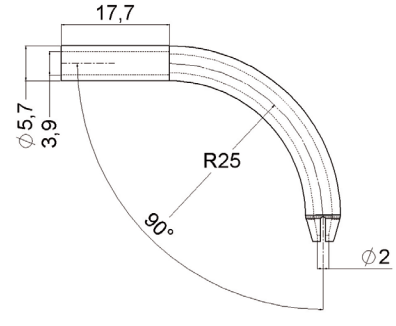

Fig. 2

Cable dia.	Figure	Part Number	Description	Packaging
2 mm	Fig 1	F718 185 200	90° short style, grey color	100
	Fig 2	F718 186 200	90° long style, grey color	100

SC ST BOOTS

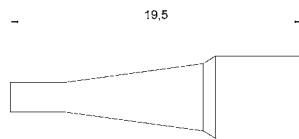

Fig. 1

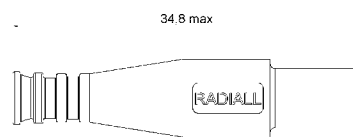

Fig. 2

Color	Cable Diameter			Packaging
	0.9 ⁽¹⁾ mm Fig 1	2 to 2.4 ⁽²⁾ mm Fig 2	2.7 to 3 ⁽²⁾ mm Fig 2	
Black	F718 105 200	F718 104 200	F718 103 200	100
Blue	F718 105 201	F718 104 201	F718 103 201	
Yellow	F718 105 202	F718 104 202	F718 103 202	
Red	F718 105 203	F718 104 203	F718 103 203	
Green	F718 105 205	F718 104 205	F718 103 205	
Beige	F718 105 206	F718 104 206	F718 103 206	
Aqua	F718 105 210	F718 104 210	F718 103 210	

⁽¹⁾These references apply to SC and FC connectors

⁽²⁾These references apply to SC, FC and ST connectors

Connector Kit Configurators

LC KIT CONFIGURATOR

You can refer to this table and build your own connector by combining different accessories with level "0" LC connector.

Cable Dia.	2 mm			3 mm		
Fiber Type	SingleMode PC	SingleMode APC	MultiMode PC	SingleMode PC	SingleMode APC	MultiMode PC
Body Color	Blue	Green	Beige	Blue	Green	Beige
Level "0"	F727 102 000	F727 152 000	F727 103 000	F727 102 000	F727 152 000	F727 103 000
Inner Sleeves	F718 158 200			F718 158 200		
Crimping Ring	F718 160 200			F718 170 200		
Straight Boot	F718 162 20x ⁽¹⁾			F718 193 20x ⁽¹⁾		
	Your final connector kit					

⁽¹⁾Replace x with the following digit for your color reference: 0: black; 1: blue; 2: yellow; 3: red; 4: white; 5: green; 6: beige; 9: aqua

Notes: Refer to previous pages for angled or super flexible boot selection.

Connector Kit Configurators

SC KIT CONFIGURATOR

You can refer to this table and complete your connector by combining different accessories with level "0".

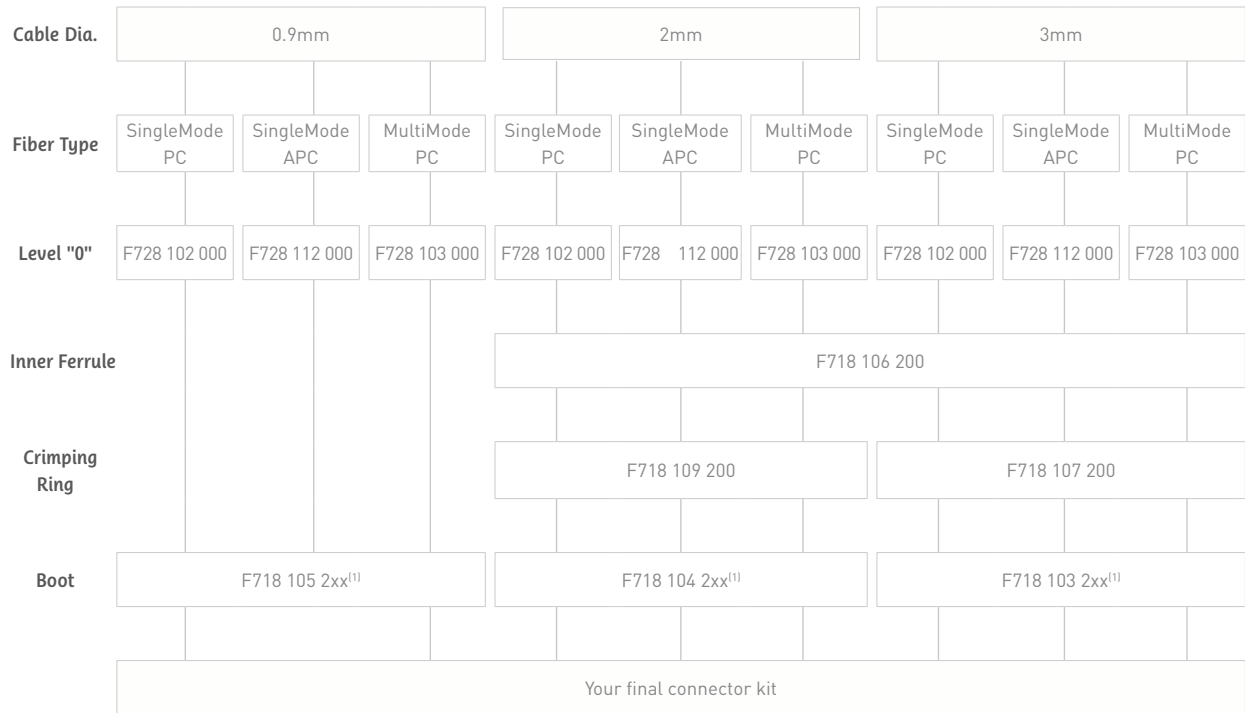

⁽¹⁾Replace x with the following digit for your color reference: 00: black; 01: blue; 02: yellow; 03: red; 05: green; 06: beige; 10: aqua

ST KIT CONFIGURATOR

You can refer to this table and complete your connector by combining different accessories with level "0".

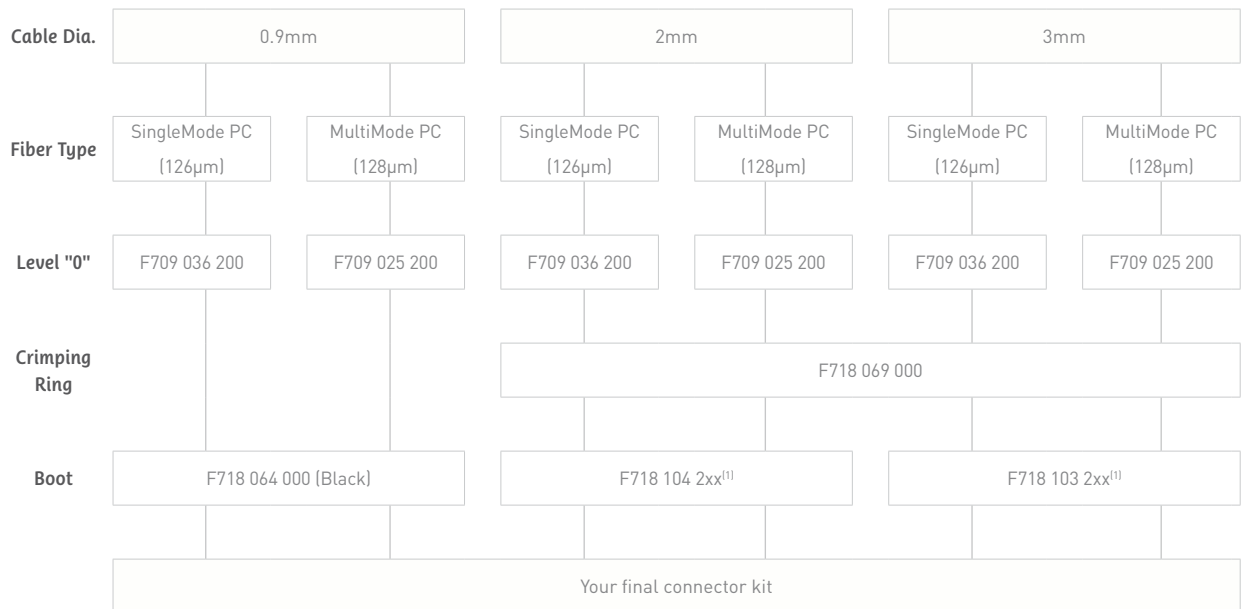

⁽¹⁾Replace x with the following digit for your color reference: 00: black; 01: blue; 02: yellow; 03: red; 05: green; 06: beige; 10: aqua

Notes

X-ON Electronics

Largest Supplier of Electrical and Electronic Components

Click to view similar products for [Fibre Optic Connectors](#) category:

Click to view products by [Radiall](#) manufacturer:

Other Similar products are found below :

[0004700001](#) [6100-R](#) [6313](#) [F709034706](#) [F709722200](#) [F709730000](#) [F718183204](#) [F727403500](#) [8119](#) [9440F20-27S-190](#) [944-120-6001](#)
[9441F10SL-3S](#) [9444W36-10S](#) [9446F10SL-4S](#) [9446W20-16S](#) [953-101-5310-P](#) [954-101-57202B](#) [A0270169](#) [12-9122](#) [12-5702](#) [AX101713](#)
[AX102420](#) [AX103923](#) [AX104024](#) [AX104193](#) [AX104230](#) [AX104498](#) [AX104562](#) [AX105203-B25](#) [AX105205-S1](#) [EHSC2M](#) [181-011-126](#)
[181-011-S](#) [181-057-126](#) [NKSOPBUY](#) [20500002116](#) [2064996-1](#) [20800001065](#) [2170](#) [9132](#) [2612](#) [2620](#) [9291](#) [9440F16-10S](#) [9440F20-18S](#)
[9440W18-1S](#) [9442W14S-10P](#) [9446F16-10S-190](#) [953-120-5003](#) [955-120-5110](#)