

PAGE 1/4	ISSUE 2017-03-01	SERIES EZ-Lux™	PART NUMBER F725 E10 000
----------	-------------------------	-----------------------	---------------------------------

EZ-Lux™ JAM NUT RECEPTACLE without boot

EZ-Lux™ was designed to be a compact, easy to mate, single channel solution for LuxCis® ARINC 801 contacts. The push-pull coupling mechanism simplifies the connection, especially in blind mating conditions.

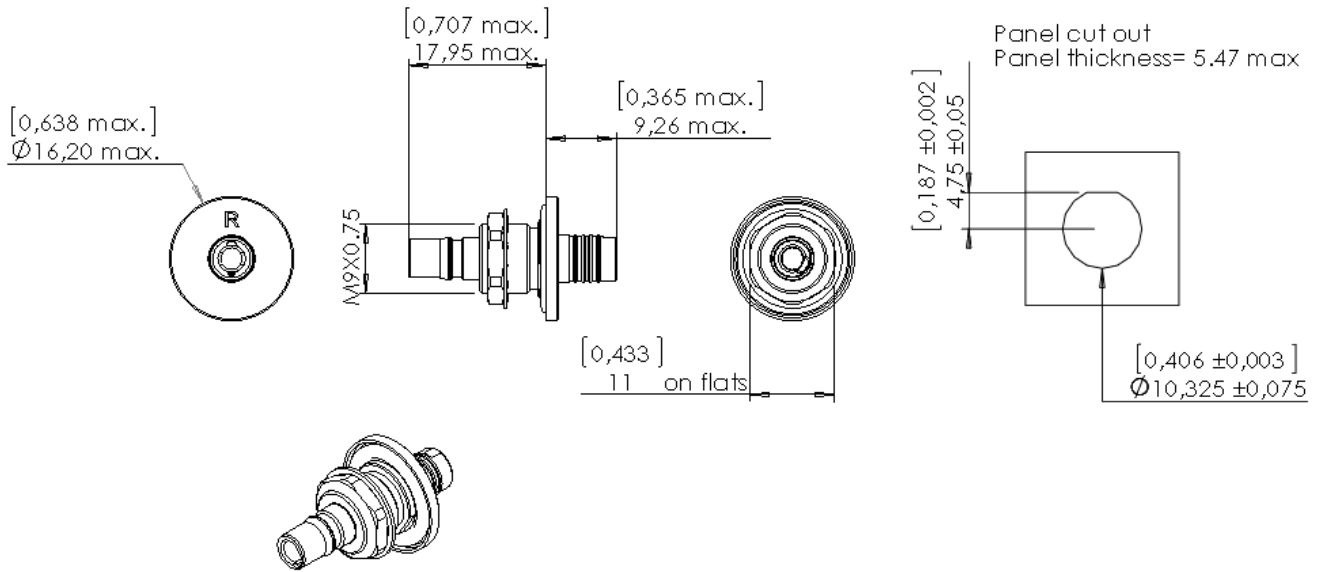

Dimensions in mm [inches] for information only

FEATURES:

- Fast & easy to use with its push-pull locking system
- Single channel connector
- Small foot print
- Push pull coupling mechanism
- Compatible with LuxCis® Arinc 801, Multimode, Singlemode PC and APC optical contact
- Suitable for fiber optic cable diameter from 1.7mm to 2mm
- Receptacle equipped with flange for an easy and secure panel mounting
- Recommended panel tightening torque: 2 N.m +/-20%



PAGE 2/4	ISSUE 2017-03-01	SERIES EZ-Lux™	PART NUMBER F725 E10 000
----------	------------------	----------------	---------------------------------

CHARACTERISTICS

OPTICAL CHARACTERISTICS WITH LUXCIS® ARINC 801 CONTACT:

Optical:	LuxCis® Arinc 801 contact		
	Multimode PC 850 / 1300 nm	Singlemode UPC 1310/1550 nm	Singlemode APC 1310/1550 nm
Insertion Loss (IL) Mean: TIA/EIA-171	0.10 dB	0.15 dB	0.20 dB
Return Loss (RL): TIA/EIA-455-107	> 20 dB	> 50 dB	> 60 dB

CHARACTERISTICS:

Qualification per Arinc 801 standard:

Mechanical:	Endurance : TIA/EIA 455-21A	100 matings*
	Cable retention : EN2591-610	68 N (<i>cable dependent</i>)

Environmental:	Temperature range :	-55 °C / +125 °C (<i>cable dependent</i>)
	Salt spray :	96 h

Material:	Body :	Brass. Plating : Nickel
	Nut :	Brass. Plating : Nickel
	Washer :	Phosphor bronze. Plating : Nickel
	Contact retention clip	Beryllium copper
	O-ring:	Fluorosilicone elastomer
	Protective cap:	Plastic

Weight:	Shell without LuxCis contact :	9.6 g approx. (W/O cap)
----------------	--------------------------------	-------------------------

* EZ-Lux™ has passed additional testing which demonstrates its suitability for 1,000 mating cycles.

PAGE 3/4	ISSUE 2017-03-01	SERIES EZ-Lux™	PART NUMBER F725 E10 000
----------	-------------------------	-----------------------	---------------------------------

INSERTION / EXTRACTION of LUXCIS® ARINC 801 CONTACT

Required material:

Radiall PN	Description	Picture
282 515	Size 16 (MIL-PRF-81969 / 14-03), Plastic insertion and extraction tool	

Insertion Process:

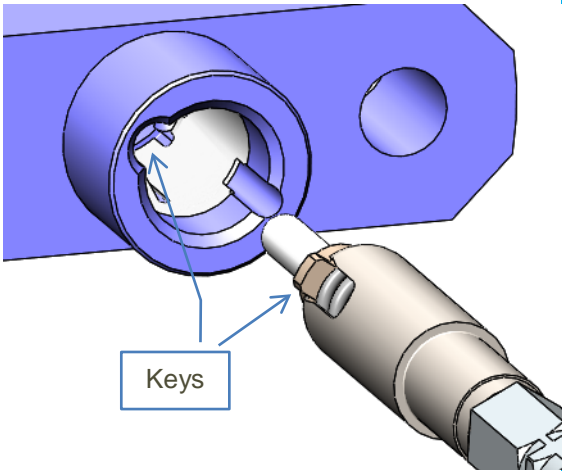
Step	Description	Pictures
1	Engage the LuxCis® Arinc 801 contact mounted onto its patchcord into the blue side of the insertion tool 282 515 . Slide the tool down the cable until the tip of the tool butts against the contact's retention shoulder.	
2	Make sure the keys of the contact and the receptacle are aligned before insertion. Introduce the contact into the receptacle cavity, pushing the tool axially, until the contact snaps into position. Remove the insertion tool and ensure that contact is firmly locked by gently pulling the patchcord.	

Extraction Process:

Use the white side of the tool (282 515) to remove the LuxCis® Arinc 801 contact.

PAGE 4/4	ISSUE 2017-03-01	SERIES EZ-Lux™	PART NUMBER F725 E10 000
----------	------------------	----------------	--------------------------

PLUG AND RECEPTACLE COUPLING

Connection:

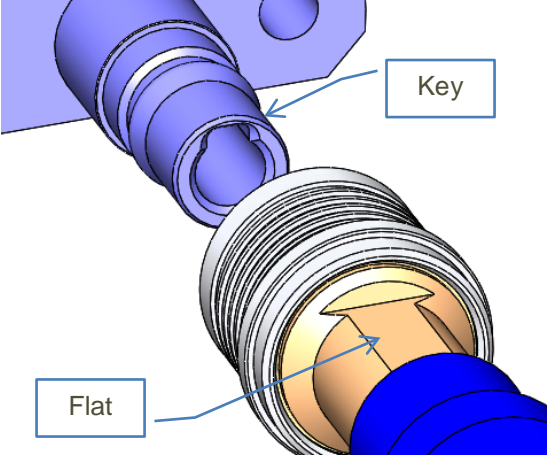
Step	Description	Pictures
1	Hold the plug by its body.	
2	Make sure the flat surface of the plug rear is aligned with the receptacle key.	
3	Push forward to mate. The connector snaps on.	

Disconnection:

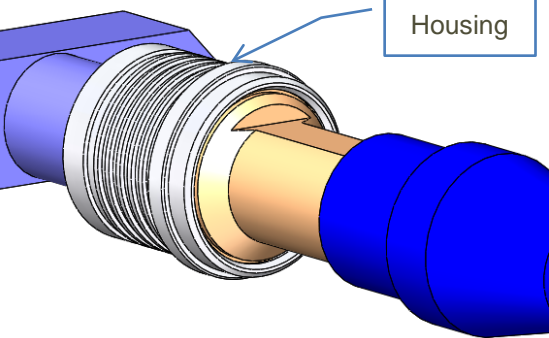
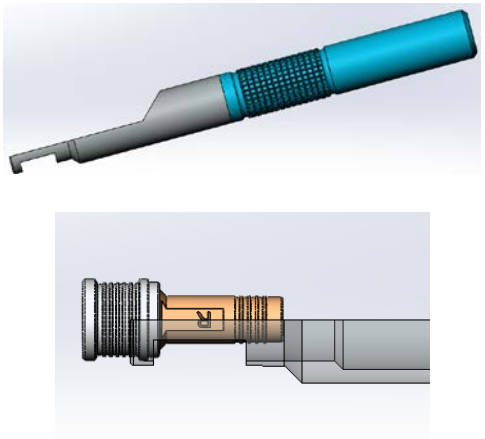
Step	Description	Pictures
1	Pull back on the plug housing.	
2	For high density panel, use the tool R282.868.230 to disconnect.	

X-ON Electronics

Largest Supplier of Electrical and Electronic Components

Click to view similar products for [Fibre Optic Connectors](#) category:

Click to view products by [Radiall](#) manufacturer:

Other Similar products are found below :

[0004700001](#) [6100-R](#) [6313](#) [F709034706](#) [F709722200](#) [F709730000](#) [F718183204](#) [F727403500](#) [F727752800](#) [8119](#) [9440F20-27S-190](#) [944-120-6001](#) [9441F10SL-3S](#) [9444W28-21S](#) [9444W36-10S](#) [9446F10SL-4S](#) [9446W20-16S](#) [953-101-5310-P](#) [954-101-57202B](#) [A0270169](#) [12-9122](#) [12-5702](#) [AX101713](#) [AX102420](#) [AX103923](#) [AX104024](#) [AX104193](#) [AX104230](#) [AX104498](#) [AX104562](#) [AX105203-B25](#) [AX105205-S1](#) [EHSC2M](#) [181-011-126](#) [181-011-S](#) [181-057-126](#) [HRFC-R2\(40\)](#) [NKSOPBUY](#) [20500002116](#) [2064996-1](#) [20800001065](#) [2170](#) [9132](#) [2612](#) [2620](#) [9291](#) [9440F16-10S](#) [9440F20-18S](#) [9446F16-10S-190](#) [953-106-50231](#)