

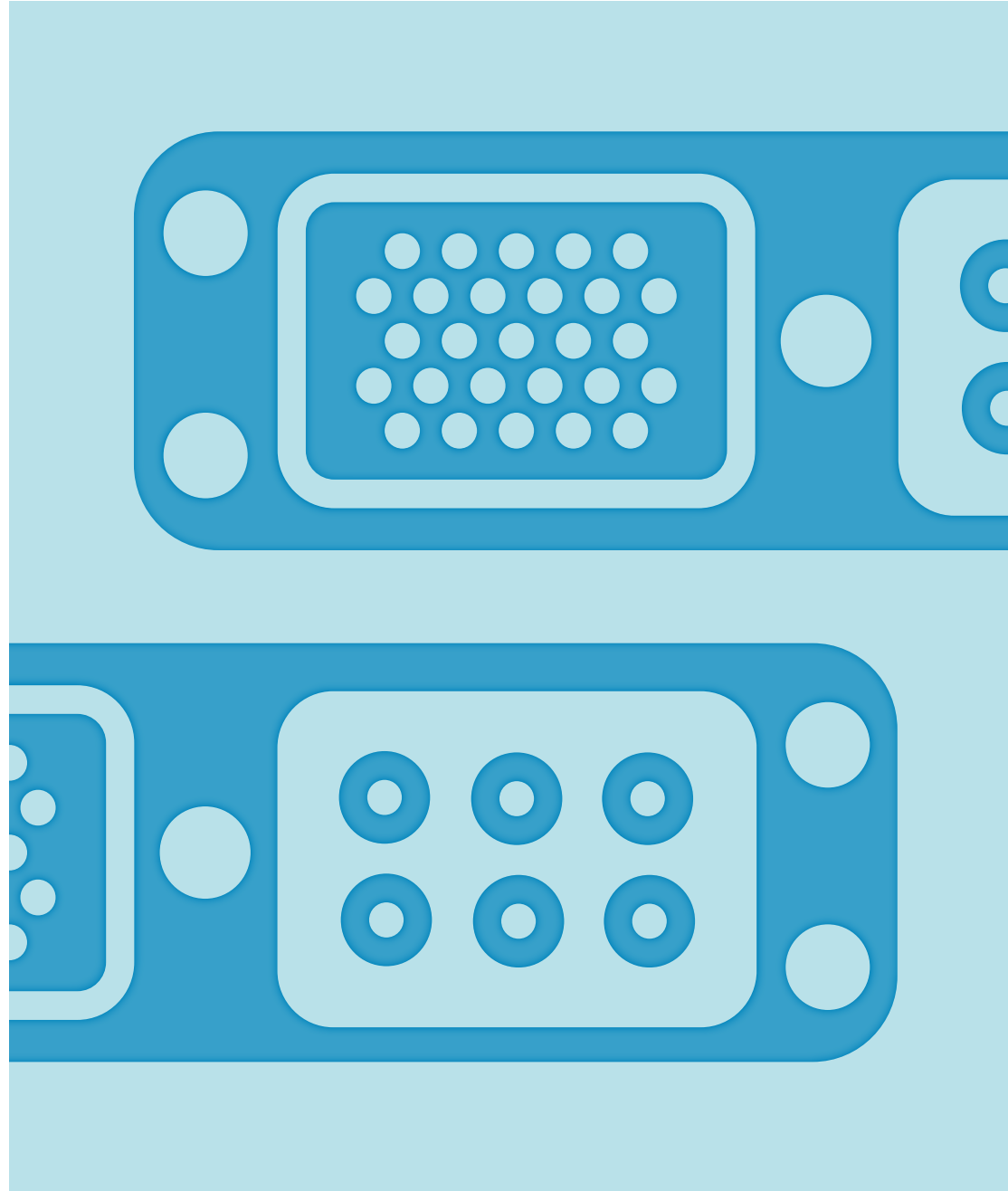

MULTIPIN



QuickFusio™ Series
Product Catalog



Connectivity has a profound and dramatic impact on the lives of people throughout the world. Because of advancements in technology, **our** lives are more convenient, more secure, more enjoyable and richer than ever. The speed of data enables communication in the **most** remote areas so people can reach all corners of the globe, allows for **important** defense and security, and facilitates space exploration. But technology doesn't just happen. It starts in the mind with ideas, making **connections** never considered in ways that nobody dreamed possible. Seeing the future in ways previously unimagined **is** the act of innovation and it begins with people—the inventors, the dreamers, the pioneers and the engineers—enriching the lives of billions. At Radiall, we have one single, solitary mission; Empower the people that enrich our lives. Enable their innovation by providing reliability and durability. Give them useful information and provide them with valuable guidance when determining the best course for success. We don't invent the future, we enable it. We inspire innovation, we embrace challenges, we challenge the conventional and we collaborate **with** you to succeed. At Radiall, we're proud to say – Our most important connection is with **you**.

Contents

Introduction	2
Range overview	4
Product selection guide	5
GigaBit Ethernet	8
Product overview	10
Insert overview	11
How to order QuickFusio™	12
Tie-wrap output positions, contact termination and coding	13
Weight	14
Dimensions	16
Electrical contacts	18
LuxCis® Arinc 801 Fiber Optic contacts	19
Accessories	20
Spare parts and tools	21

TABLE OF CONTENTS

Introduction

Radiall's experience in rectangular connectors and ability to design innovative solutions make the QuickFusio™ series the perfect miniature interconnect solution for cabin interiors and EWIS aerospace applications. Combining high performance with competitive costs, this lightweight, tool-less connector features The Radiall Touch: one finger mating - in a snap!

The QuickFusio™ series is a versatile range that covers any wiring systems including harness-to-harness and equipment-to-harness. The QuickFusio™ series is available in different shell styles in order to make installing the miniature connector in any aircraft area feasible.



Panel mount

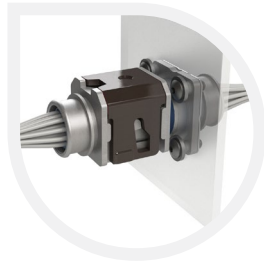

Box mount

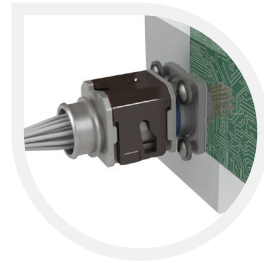

Bundle mount

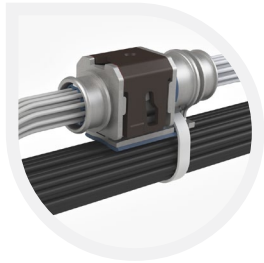

Structure mount



APPLICATIONS

The QuickFusio™ series is the perfect solution for major commercial aerospace and defense OEMs and is perfectly suited for:

- Cabin Interiors: In Flight Entertainment (IFE), Lighting, Seats, Passenger Service Units (PSU)
- Electrical Wiring Systems (EWIS)
- Actuators



Introduction

FEATURES & BENEFITS



Competitive Cost

QuickFusio™ series is optimized to meet customer expectations in terms of competitive **price positioning**. The use of standard **SAE-AS-38999 contacts** in QuickFusio™ inserts and the unique mating mechanism enables **quick mating** and reduces overall cost.



Simple Wiring

By **squaring a circle**, Radiall has created an innovative design compatible with standard **SAE-AS-38999 size 11 accessories**. The unique design covers **any type of wiring** combination and is easy to install due to the **Radiall Touch**: one finger mating – in a snap !











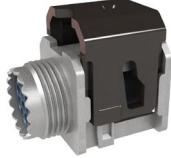

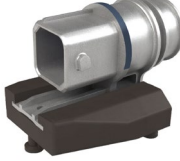

Lightweight Solution

Extremely compact, **QuickFusio™ series is 20% lighter and 40% smaller** than the competition. This small, dense solution eliminates wasted space and reduces the overall weight. QuickFusio™ is only **20 grams** per pair when equipped with size 22 contacts.

QUICKFUSIO™

Range Overview

Plugs	Receptacles (Mateable with all plugs)			
	Receptacle outputs	Square flange receptacle for panel and box mount ⁽¹⁾	In-line receptacle for bundle mount ⁽²⁾	Stand-alone receptacle for structure mount ⁽²⁾
 Threaded accessory	Threaded output			
 Banding platform	Banding platform output			
 Banding platform and tie-wrap ⁽²⁾	Banding platform and tie-wrap output			
 Short receptacle output with straight PC tail contacts	Short receptacle output with straight PC tail contacts			
 Short receptacle output with right angle PC tail contacts	Short receptacle output with right angle PC tail contacts			

NOTE:

(1) Sealed square flange versions will soon complete the existing square flange receptacle range. Please contact your local representative for additional information.

(2) Shell style not yet available. Please contact your local representative for additional information.

Product Selection Guide

TWO INNOVATIVE SOLUTIONS TO MEET CUSTOMERS NEEDS

To meet all customers needs and expectations, the QuickFusio™ series is available in two different versions: QuickFusio and QuickFusio+

- The QuickFusio connector offers the perfect balance between extreme competitive cost and performance needed in pressurized environments, especially in cabin applications.
- Qualified in accordance to EWIS standard, the QuickFusio+ connector meets even more stringent requirements and is suitable for both pressurized and non-pressurized environments.

To choose your connector, determine your performance requirements below:

Performance	QuickFusio	QuickFusio+
Operating temperature	-55°C to +125°C (-67°F to +257°F)	-65°C to +175°C (-85°F to +347°F)
Altitude immersion	No sealing	55,000 feet
DWV at 70,000 feet (mated connector)	325 Vrms	1000 Vrms
Salt spray	48 h	96 h
Vibrations	20 g Sinus - 4 hours on each of the 3 axis	27.8 grms - 8 hours on each of the 3 axis
Lightning strike	N/A	5 KA - 1600 V
Shell to shell conductivity	10 mΩ max	2.5 mΩ max

How to differentiate your connectors?

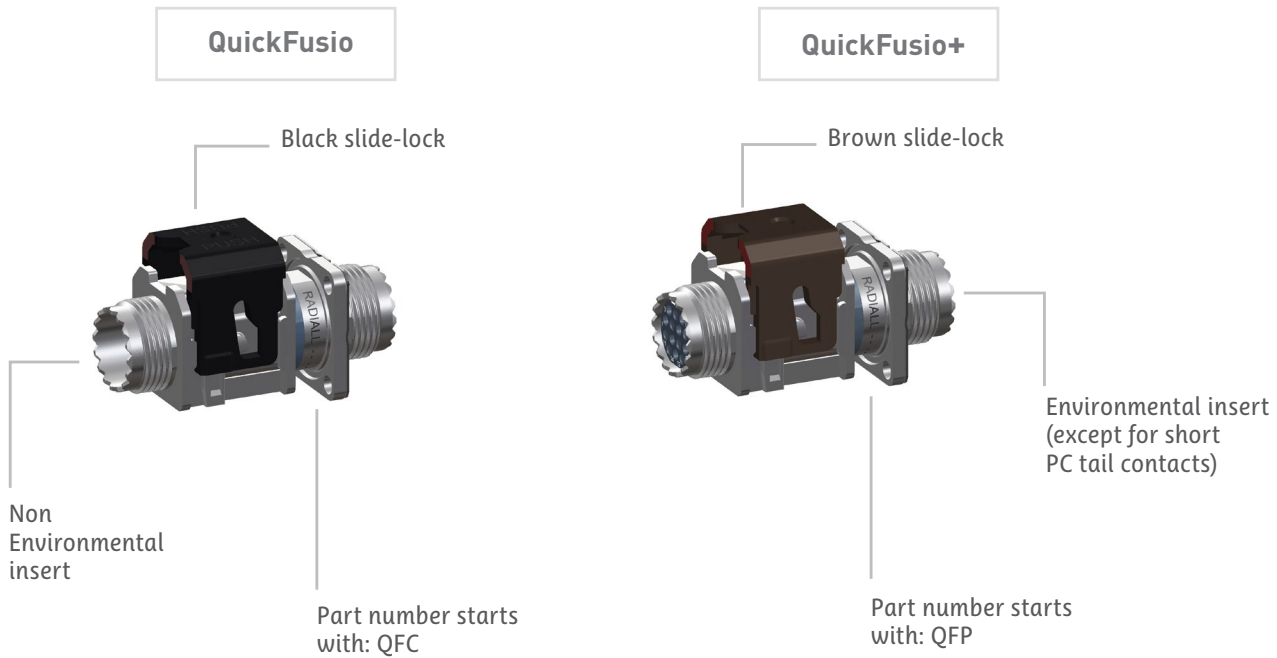

Technical Characteristics

ELECTRICAL CHARACTERISTICS

			QuickFusio	QuickFusio+
Current rating	Contact size	Cable gauge	Max current amps (A)	Max current amps (A)
	23	AWG22	5	5
		AWG24	3	3
		AWG26	2	2
	22	AWG22	5	5
		AWG24	3	3
		AWG26	2	2
	20	AWG20	7.5	7.5
		AWG22	5	5
		AWG24	3	3
	16	AWG16	13	13
		AWG18	10	10
		AWG20	7.5	7.5
12	AWG12	23	23	
	AWG14	17	17	
	AWG16	13	13	

			QuickFusio	QuickFusio+
Dielectric withstanding voltage (DWV)	At sea level	All inserts	1500 Vrms	1500 Vrms
		Insert 22	1000 Vrms	1300 Vrms
		Insert Q1	N/A	1000 Vrms
	At 70,000 feet	All inserts	325 Vrms	1000 Vrms
		Insert 22	125 Vrms	325 Vrms
		Insert Q1	N/A	125 Vrms
Insulation resistance	Ambient temperature	>5000 MΩ	>5000 MΩ	
	At high temperature	>200 MΩ at 125°C	>200 MΩ at 175°C	
Lightning strike	Current pulse	N/A	5KA	
	Voltage pulse	N/A	1600 V	

		QuickFusio	QuickFusio+
EMI shielding effectiveness	Frequency (MHz)	Leakage attenuation (dB)	Leakage attenuation (dB)
	100	65	65
	200	63	63
	300	63	63
	400	62	62
	500	60	60
	600	55	55
	800	50	50
	1000	50	50

	QuickFusio	QuickFusio+
Shell to shell conductivity	10 mΩ max	2.5 mΩ max
Magnetic permeability	<2μ	<2μ

Technical Characteristics

MECHANICAL CHARACTERISTICS

	QuickFusio			QuickFusio+	
Contact retention	Contact size	Retention force	Max displacement	Retention force	Max displacement
	23	44 N	0.30 mm	44 N	0.30 mm
	22	44 N		44 N	
	20	67 N		67 N	
	16	110 N		110 N	
12	110 N	110 N			
Contact insertion extraction force	Contact size	Maximum insertion force	Maximum extraction force	Maximum insertion force	Maximum extraction force
	23	44 N	44 N	44 N	44 N
	22	44 N	44 N	44 N	44 N
	20	89 N	89 N	89 N	89 N
	16	89 N	89 N	89 N	89 N
12	133 N	133 N	133 N	133 N	

	QuickFusio	QuickFusio+
Mechanical endurance	500 mating cycles	500 mating cycles
Vibration	Acceleration 20g sinus (4 hours on each of the 3 axis)	Acceleration 27.8 grms (8 hours on each of the 3 axis)
Shock 3 shocks on each axis	Shock amplitude 50 half sinus / duration 11 ms	Shock amplitude 50 half sinus / duration 11 ms
Insert retention in shell	254 N	254 N

ENVIRONMENTAL CHARACTERISTICS

	QuickFusio	QuickFusio+
Operating temperature	-55°C to +125°C (-67°F to +257°F)	-65°C to +175°C (-85°F to +347°F)
Temperature life	1000 hours at 125°C	1000 hours at 175°C
Salt spray	48 hours	96 hours
Altitude immersion (all inserts except 22)	No sealing	55,000 feet
Seal leakage (class B) - insert 22	N/A	Resistant to running water
Flammability	EN 2591-317 FAR 25,853	EN 2591-317 FAR 25,853
Smoke and toxicity	EN 2591-317 FAR 25,853 (F)	EN 2591-317 FAR 25,853 (F)

QUICKFUSIO™

GigaBit Ethernet

Growing demands in the civil aerospace market for faster digital networks has boosted the development of GigaBit Ethernet protocols. This opens new perspectives for cabin and flight management systems, in-flight entertainment (IFE) and avionics networks.

To respond to market demand, Radiall has developed a dedicated insert called IG for both plugs and receptacles. Exceeding 1Gb/sec⁽¹⁾, the QuickFusio™ series passes the cat5e performance level and is available in two Ethernet cable configurations.

SINGLE ETHERNET CABLE CONFIGURATION

The single Ethernet cable configuration is available with QuickFusio and QuickFusio+. To pass the Ethernet cat5e performance level in accordance with ARINC specification 800 part 4, a 13.80 m harness with 6 QuickFusio connections and Gore Ethernet cable RCN9047-26 was tested.

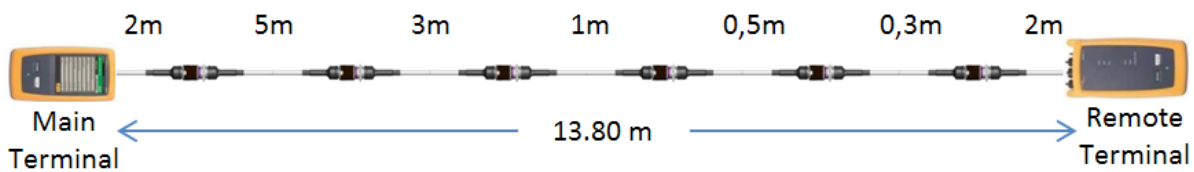

To achieve the level of performance shown below, a dedicated layout configuration was developed which preserves signal integrity while minimizing crosstalk, insertion loss and return loss effects.

Single Ethernet cable insert layout and data transmission characteristics:

Insert IG contact mapping

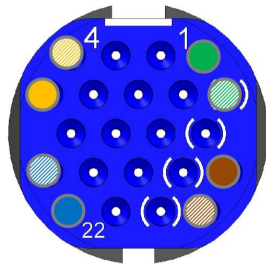

Near end crosstalk (NEXT):

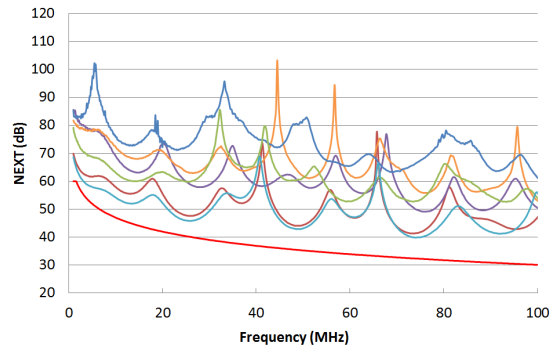

Insertion Loss (IL):

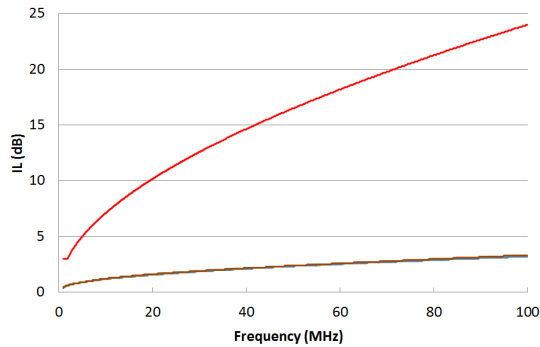

Return Loss (RL):

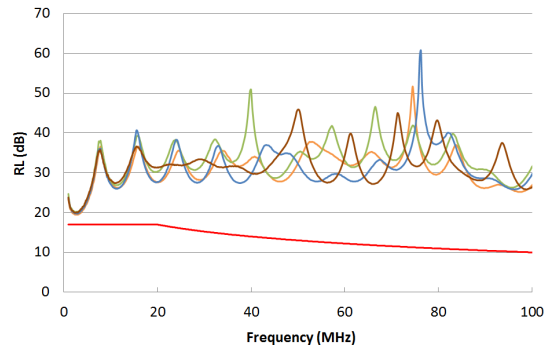

Refer to mounting instructions ref. MIN IN 27 00004 EN (QuickFusio) and ref. MIN IN 2700001 EN (QuickFusio+) to insure proper cable and connector assembly.

NOTE:

(1): Please contact your sale representative for higher data rate performance.

GigaBit Ethernet

DOUBLE ETHERNET CABLE CONFIGURATION

Available with the QuickFusio connector, the double Ethernet cable configuration offers customers a higher density solution. This configuration which also passes the Ethernet cat5e performance level, has been tested with a harness made of 7 QuickFusio connections totaling 12.58m length and a Thermax MX10G-26FLX Ethernet cable.

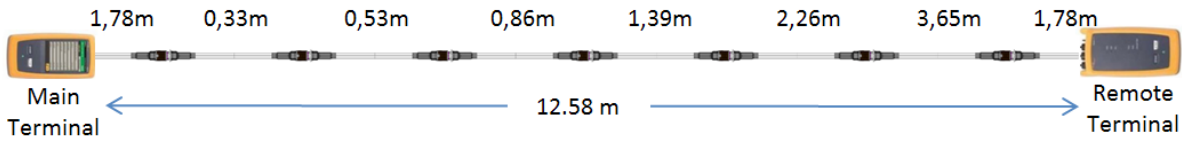

Double Ethernet cable insert layout and data transmission characteristics:

Insert IG contact mapping

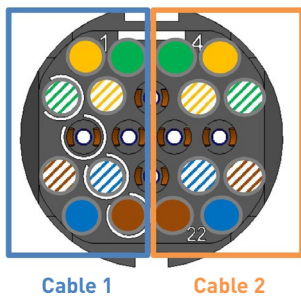

Near end crosstalk (NEXT):

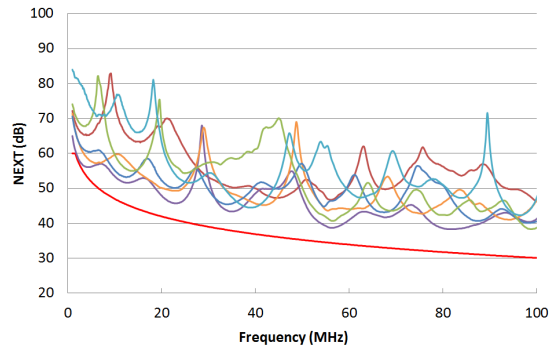

Insertion Loss (IL):

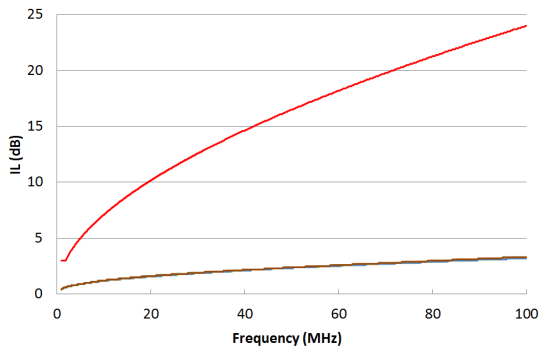

Return Loss (RL):

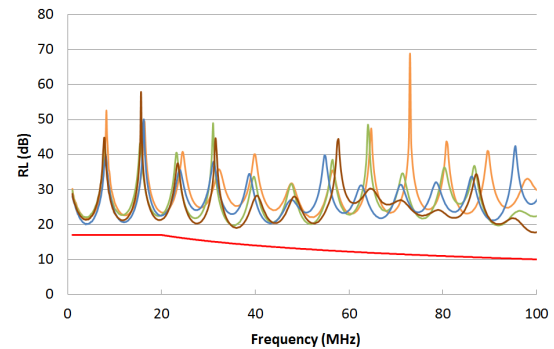

Refer to mounting instructions ref. MI IN 27 00001 EN (QuickFusio) to ensure proper cable and connector assembly.

Complete qualification test reports are available upon request.

Product Overview

QUICKFUSIO

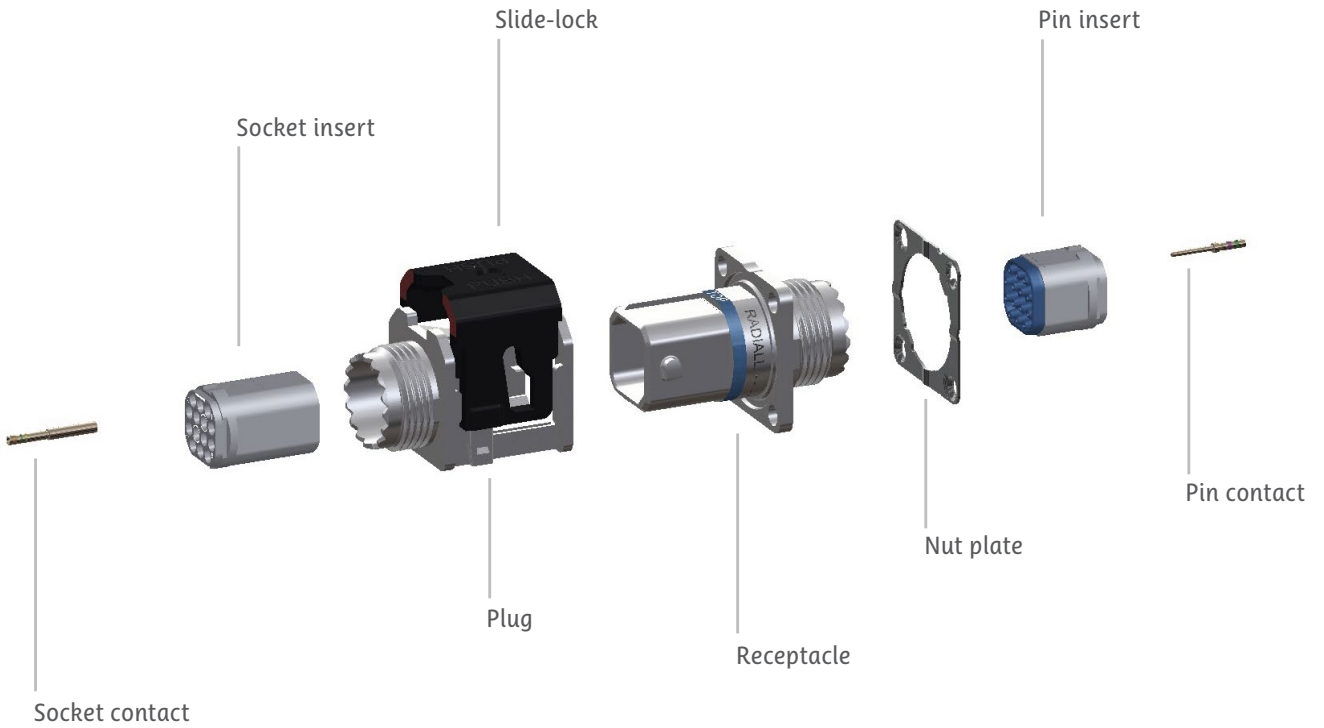

MATERIALS AND PLATING

- **Plug and receptacle shells:** high grade thermoplastic (nickel plated)
- **Insert retention clip:** beryllium copper
- **Insert:** high grade thermoplastic with metallic retention clip
- **Contact:** copper alloy, gold plated over nickel
- **Slide lock (plug):** high grade thermoplastic
- **O-ring, grommet and interfacial seal:** fluorosilicone elastomer
- **Nut plate (receptacle):** stainless steel

Insert Overview

NON-ENVIRONMENTAL INSERTS

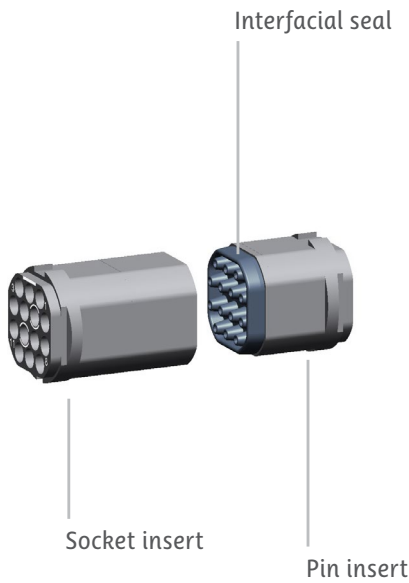

ENVIRONMENTAL INSERTS

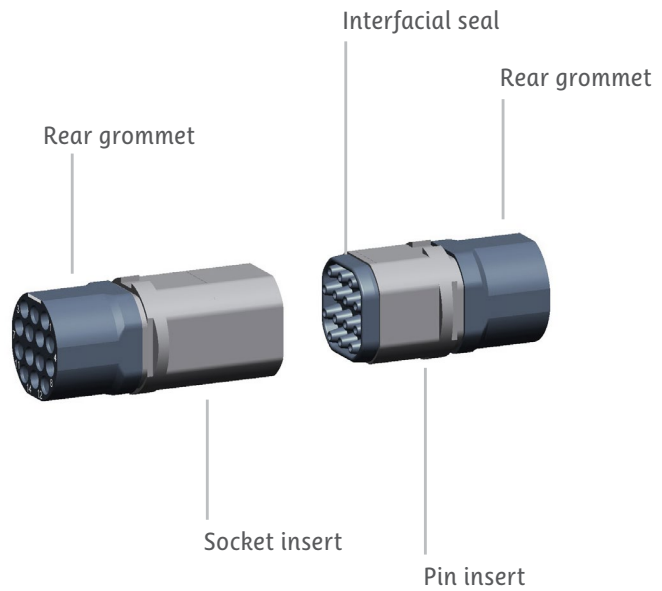

INSERT ARRANGEMENTS

Except for F4 and Q1 inserts, all inserts are available in environmental and non-environmental versions.

Insert name 22 22 x size 23 contacts	Insert name 14 14 x size 22 contacts	Insert name 07 7 x size 20 contacts	Insert name 04 4 x size 16 contacts
Insert name F4 4 x LuxCis® Arinc 801 contacts	Insert name Q1 1 x size 8 quadrax contact	Insert name M4 3 x size 20 contacts 1 x size 12 contact	Insert name IG for GigaBit Ethernet applications

● Insert available in environmental version only

How to order QuickFusio™

QuickFusio is delivered fully assembled including the shell, with insert mounted and with or without contacts based on your selection.

Tips to help you in your selection:

- QuickFusio+ connectors are fitted with environmental inserts (except for receptacles with short PC tail contacts fitted with non-environmental inserts).
- QuickFusio connectors are always fitted with non-environmental inserts.
- For crimp contacts, you can use either pin or socket inserts in QuickFusio and QuickFusio+ plugs or receptacles (however, if scoop proof option is needed, please use pin inserts in receptacles).
- PC tail contacts are only available as pin PC tail contacts in short receptacle rear output (if PC tails are selected then all the cavities are populated).

QFC	5	PN	1	N	14	P	X	A
Series prefix								
QFC: QuickFusio								
QFP: QuickFusio+								
Shell size								
5: One size available								
Shell type⁽¹⁾								
PN: Plug (Nickel plated)								
RN: Square Flange receptacle (Nickel plated)								
Rear Output								
1: Short receptacle								
2: Accessory thread								
3: Banding platform								
A: Banding platform and tie-wrap (orientation 0°) ⁽¹⁾								
Insert class⁽²⁾								
N: Non-environmental (without grommet, always the interfacial seal on pin insert)								
E: Environmental (for QuickFusio+ only)								
Insert name								
Refer to page 11 to select your insert name								
Insert type⁽³⁾								
P: Pin inserts								
S: Socket inserts								
Contact termination⁽⁴⁾								
X: Contact not supplied with the connector								
S: Crimp contacts are supplied with connector								
YB: Gold finish straight PC tail contacts ^{(5) & (6)}								
GB: Gold finish right angle PC tail contacts ^{(5) & (6)}								
RB: Pure tin straight PC tail contacts ^{(5) & (6)}								
TB: Pure tin right angle PC tail contacts ^{(5) & (6)}								
] Refer to page 13 for PC tail lengths								
Coding								
Refer to page 13 to select your coding (A to N)								

NOTE:

(1) For other options, please contact your local representative

(2) Refer to the table below to select your insert class:

Contact Termination	QuickFusio		QuickFusio+	
	Non environmental	Non environmental	Environmental	Environmental
X	✓			✓
S	✓			✓
YB to TB	✓	✓		

(3) For F4 insert: pin inserts only available on plug side and socket inserts with sleeve holder on receptacle side.

(4) Size 8 and optical contacts must be ordered separately

(5) F4, Q1 and IG inserts are not available with PC tail contacts

(6) Only available with short receptacle rear output (1)

Tie-wrap Output Positions, Contact Terminations and Coding

TIE-WRAP OUTPUT ANGULAR POSITIONS

For tie-wrap output orientation 90°, 180° or 270° please contact your local representative for additional information.

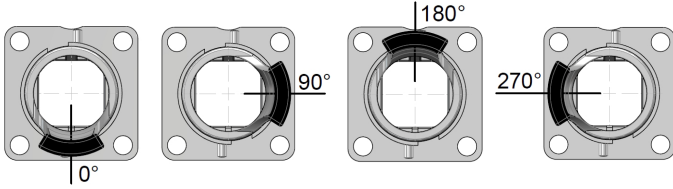

CONTACT TERMINATION

Straight PC tail contact termination Size #23 to size #12 contacts			
Mini length E mm (inch)	Mini length H mm (inch)	Gold	Pure tin (RoHS)
14.25 (0.561)	7.42 (0.292)	YB	RB

Right angle PC tail contact termination Size #23 to size #12 contacts			
Mini length E mm (inch)	Mini length H mm (inch)	Gold	Pure tin (RoHS)
12.19 (0.480)	4.43 (0.174)	GB	TB

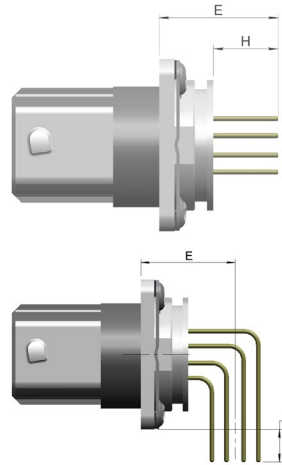

CODING

The QuickFusio™ series is available in 6 different codings through specific mechanical shapes. Each of these mechanical codings is associated with one particular color, which enables quick and easy wiring. One universal N coding, mateable with the 6 other codings, is also available.

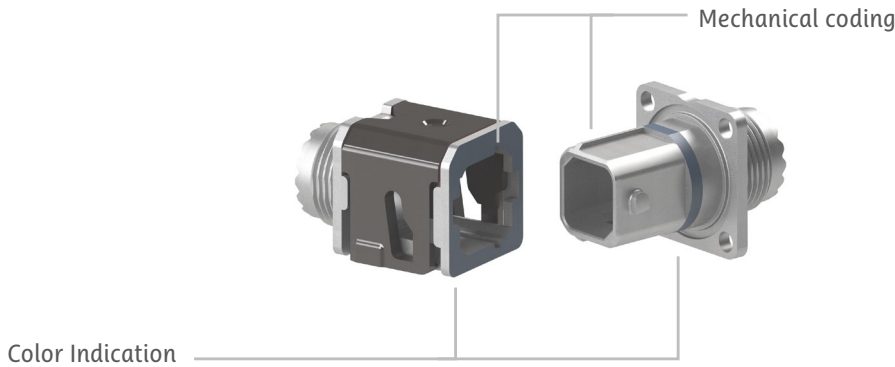

	Coding A	Coding B	Coding C	Coding D	Coding E	Coding F	Coding N Universal Coding
Color and mechanical shape coding							

Weight

QUICKFUSIO

Plug ⁽¹⁾				
Insert name	Insert type	Threaded accessory	Banding platform	Banding platform and tie wrap
22	Pin	8.50 g (0.30 oz)	8.60 g (0.30 oz)	8.90 g (0.31 oz)
22	Socket	9.20 g (0.33 oz)	9.30 g (0.33 oz)	9.60 g (0.34 oz)
14	Pin	8.50 g (0.30 oz)	8.60 g (0.30oz)	8.90 g (0.31 oz)
14	Socket	9.20 g (0.33 oz)	9.30 g (0.33 oz)	9.60 g (0.34 oz)
07	Pin	8.15 g (0.29 oz)	8.25 g (0.29 oz)	8.55 g (0.30 oz)
07	Socket	8.60 g (0.30 oz)	8.70 g (0.30 oz)	9.00 g (0.32 oz)
04	Pin	8.15 g (0.29 oz)	8.25 g (0.29 oz)	8.55 g (0.30 oz)
04	Socket	8.60 g (0.30 oz)	8.70 g (0.30 oz)	9.00 g (0.32 oz)
M4	Pin	8.15 g (0.29 oz)	8.25 g (0.29 oz)	8.55 g (0.30 oz)
M4	Socket	8.60 g (0.30 oz)	8.70 g (0.30 oz)	9.00 g (0.32 oz)

Square flange receptacle ⁽¹⁾					
Insert name	Insert type	Threaded accessory	Banding platform	Banding platform and tie wrap	Short receptacle
22	Pin	7.20 g (0.25 oz)	7.30 g (0.26 oz)	7.60 g (0.27 oz)	6.75 g (0.24 oz)
22	Socket	7.85 g (0.28 oz)	7.95 g (0.28 oz)	8.25 g (0.29 oz)	N/A
14	Pin	7.20 g (0.25 oz)	7.30 g (0.26 oz)	7.60 g (0.27 oz)	6.75 g (0.24 oz)
14	Socket	7.85 g (0.28 oz)	7.95 g (0.28 oz)	8.25 g (0.29 oz)	N/A
07	Pin	6.85 g (0.25 oz)	6.95 g (0.25 oz)	7.25 g (0.26 oz)	6.40 g (0.23 oz)
07	Socket	7.30 g (0.26 oz)	7.40 g (0.26 oz)	7.70 g (0.27 oz)	N/A
04	Pin	6.85 g (0.25 oz)	6.95 g (0.25 oz)	7.25 g (0.26 oz)	6.40 g (0.23 oz)
04	Socket	7.30 g (0.26oz)	7.40 g (0.26 oz)	7.70 g (0.27 oz)	N/A
M4	Pin	6.85 g (0.25 oz)	6.95 g (0.25 oz)	7.25 g (0.26 oz)	6.40 g (0.23 oz)
M4	Socket	7.30 g (0.26 oz)	7.40 g (0.26 oz)	7.70 g (0.27 oz)	N/A

NOTE:

(1) Connector weight includes non-environmental insert only without contacts.

Weight

QUICKFUSIO+

QUICKFUSIO™

Plug ⁽¹⁾				
Insert name	Insert type	Threaded accessory	Banding platform	Banding platform and tie wrap
22	Pin	9.45 g [0.33oz]	9.55 g [0.34 oz]	9.85 g [0.35 oz]
22	Socket	10.10 g [0.36 oz]	10.20 g [0.36 oz]	10.50 g [0.377 oz]
14	Pin	9.35 g [0.33 oz]	9.45 g [0.33 oz]	9.75 g [0.34 oz]
14	Socket	10.00 g [0.35 oz]	10.10 g [0.36 oz]	10.40 g [0.37 oz]
07	Pin	9.05 g [0.32 oz]	9.15 g [0.32 oz]	9.45 g [0.33 oz]
07	Socket	9.50 g [0.34 oz]	9.60 g [0.34 oz]	9.90 g [0.35 oz]
04	Pin	9.00 g [0.32 oz]	9.10 g [0.32 oz]	9.40 g [0.33 oz]
04	Socket	9.45 g [0.33 oz]	9.55 g [0.34 oz]	9.85 g [0.35 oz]
F4	Pin	9.50 g [0.34 oz]	9.60 g [0.34 oz]	9.90 g [0.35 oz]
Q1	Pin	8.60 g [0.30 oz]	8.70 g [0.31 oz]	9.00 g [0.32 oz]
Q1	Socket	9.25 g [0.33 oz]	9.35 g [0.33 oz]	9.65 g [0.34 oz]
M4	Pin	9.05 g [0.32 oz]	9.15 g [0.32 oz]	9.45 g [0.33 oz]
M4	Socket	9.50 g [0.34 oz]	9.60 g [0.34 oz]	9.90 g [0.35 oz]

Square flange receptacle ⁽¹⁾						
Insert name	Insert type	Threaded accessory	Banding platform	Banding platform and tie wrap	Short receptacle	
					Non-environmental	Environmental
22	Pin	8.10 g [0.29 oz]	8.20 g [0.29 oz]	8.50 g [0.30 oz]	6.75 g [0.24 oz]	7.70 g [0.28 oz]
22	Socket	8.80 g [0.31 oz]	8.90 g [0.31 oz]	9.20 g [0.32 oz]	N/A	8.35 g [0.30 oz]
14	Pin	8.00 g [0.28 oz]	8.10 g [0.29 oz]	8.40 g [0.30 oz]	6.75 g [0.24 oz]	7.55 g [0.27 oz]
14	Socket	8.65 g [0.31 oz]	8.75 g [0.31 oz]	9.05 g [0.32 oz]	N/A	8.20 g [0.29 oz]
07	Pin	7.75 g [0.27 oz]	7.85 g [0.28 oz]	8.15 g [0.29 oz]	6.40 g [0.23 oz]	7.30 g [0.26 oz]
07	Socket	8.20 g [0.29 oz]	8.30 g [0.29 oz]	8.60 g [0.30 oz]	N/A	7.75 g [0.28 oz]
04	Pin	7.70 g [0.27 oz]	7.80 g [0.28 oz]	8.10 g [0.29 oz]	6.40 g [0.23 oz]	7.25 g [0.26 oz]
04	Socket	8.10 g [0.29 oz]	8.20 g [0.29 oz]	8.50 g [0.30 oz]	N/A	7.65 g [0.27 oz]
F4	Socket	9.00 g [0.32 oz]	9.10 g [0.32 oz]	9.40 g [0.33 oz]	N/A	8.60 g [0.31 oz]
Q1	Pin	7.30 g [0.26 oz]	7.40 g [0.26 oz]	7.70 g [0.27 oz]	N/A	6.85 g [0.25 oz]
Q1	Socket	7.95 g [0.28 oz]	8.05 g [0.28 oz]	8.35 g [0.29 oz]	N/A	7.50 g [0.27 oz]
M4	Pin	7.75 g [0.27 oz]	7.85 g [0.28 oz]	8.15 g [0.29 oz]	6.40 g [0.23 oz]	7.30 g [0.26 oz]
M4	Socket	8.20 g [0.29 oz]	8.30 g [0.29 oz]	8.60 g [0.30 oz]	N/A	7.75 g [0.28 oz]

NOTE:

(1) When no further indication, connector weight includes environmental insert without contacts.

Dimensions

PLUGS - QUICKFUSIO AND QUICKFUSIO+ (PN)

Standard dimensions

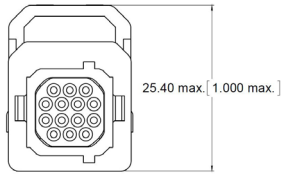

Slide opened

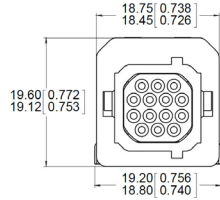

Slide closed

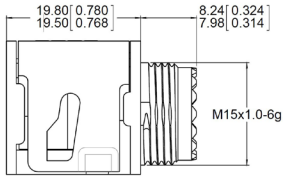

Rear output #2
Accessory Thread

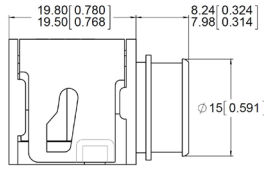

Rear output #3
Banding platform

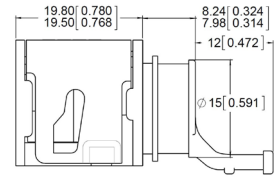

Rear output #A
Banding platform
and tie-wrap

Specific dimensions for environmental inserts F4 - Q1

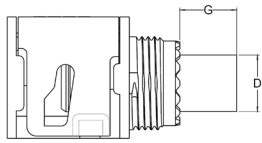

Rear output #2
Accessory Thread

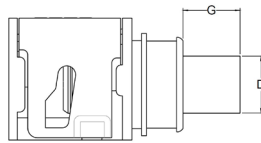

Rear output #3
Banding platform

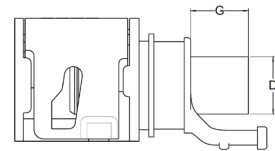

Rear output #A
Banding platform
and tie-wrap

Insert name	Grommet protrusion (G) max mm (inch)	Grommet diameter (D) max mm (inch)
F4	9.5 (0.37)	10.95 (0.43)
Q1	3.5 (0.14)	11.25 (0.44)

Dimensions

SQUARE FLANGE RECEPTACLES QUICKFUSIO AND QUICKFUSIO+ (RN)

Standard dimensions

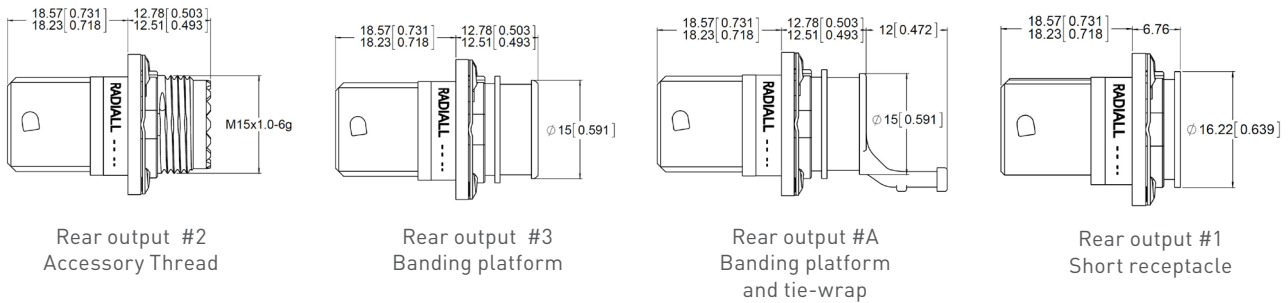
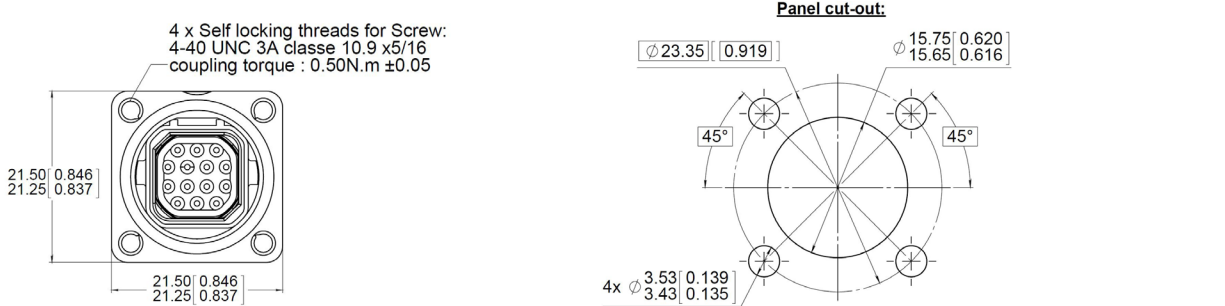

Specific Dimensions for environmental inserts

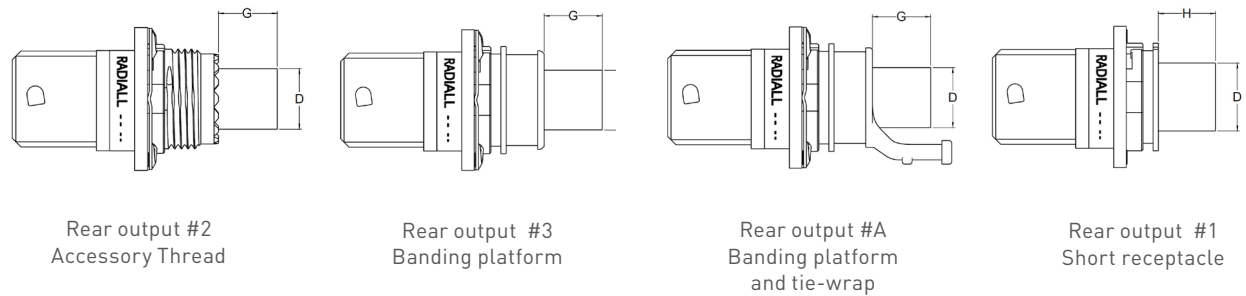

Insert name	Grommet protrusion (G) max for output #2, #3 and #A mm (inch)	Grommet protrusion (H) max for output #1 mm (inch)	Grommet diameter (D) max mm (inch)
F4	9.5 (0.37)	N/A	10.95 (0.43)
Q1	3.5 (0.14)	9.38 (0.37)	11.25 (0.44)
14/07/04/M4	None	5.53 (0.22)	10.95 (0.43)
22	None	5.53 (0.22)	12.00 (0.47)

Electrical Contacts

QuickFusio connectors use highly standardized contacts per SAE-AS39029 and EN3155:

- Signal and power contacts
- High frequency with coax, twinax and triax contacts
- Ethernet links with Quadrax contacts
- Fiber Optic

Signal and power crimp contacts

Contact size	Wire size	Type	Radiall part number	Standard part number	Crimping tool	Positioner	Ins./ext. tool	Type of tool
23	AWG22 AWG24 AWG26	Pin	670210	N/A	282281 M22520/2-01	282581019	282549049 ¹ M81969/1-05	Metal
		Socket	670310	N/A				
22	AWG22 AWG24 AWG26	Pin	670200	M39029/58-360 EN3155-008P2222	282281 M22520/2-01	282562 M22520/2-09	282522 M81969/14-01	Plastic
		Socket	670350	M39029/57-354 EN3155-003S2222				
20	AWG20 AWG22 AWG24	Pin	670220	M39029/58-363 EN3155-008P2020	282291 M22520/1-01	282567 M22520/1-04	282549029 M81969/14-10	Plastic
		Socket	670370	M39029/57-357 EN3155-003S2020				
16	AWG16 AWG18 AWG20	Pin	670230	M39029/58-364 EN3155-008P1616	282291 M22520/1-01	282567 M22520/1-04	282515 M81969/14-03	Plastic
		Socket	670380	M39029/57-358 EN3155-003S1616				
12	AWG12 AWG14 AWG16	Pin	670240	M39029/58-365 EN3155-008P1212	282291 M22520/1-01	282567 M22520/1-04	282549004 M81969/14-04	Plastic
		Socket	670390	M39029/57-359 EN3155-003S1212				

Quadrax crimp contacts

Contact size	Wire size	Class	Type	Radiall part number	Extraction tool	Type of tool
8	NF24Q100	Environmental	Pin	670175012	282549001 M81969/28-03 or M81969/14-06	Metal
			Socket	670075012		
	NF26Q100	Environmental	Socket	670075029		
		Non-environmental	Socket	670075028		
	ABS1503KD24	Environmental	Pin	670175023		
			Socket	670075023		

Coaxial crimp contacts

Contact size	Wire size	Class	Type	Radiall part number	Extraction tool	Type of tool
8	EN4604-010 (KX)	Non-environmental	Pin	670101007	282549001 M81969/28-03 or M81969/14-06	Metal
			Socket	670001007		

QuickFusio is also compatible with coaxial contacts EN3155-067 and EN3155-068

Triax contacts

QuickFusio is compatible with triax contacts per EN3155-012; EN3155-024; EN3155-013 and EN3155-025

NOTE:

(1) Not yet available. Please contact your local representative for additional information.

LuxCis® Arinc 801 Fiber Optic Contacts

The LuxCis® Arinc 801 product range is a proven and flexible fiber optic interconnect solution that offers high speed communication in the aerospace market and other harsh environments.

OPTICAL PERFORMANCE

	SingleMode UPC	SingleMode APC	MultiMode PC
Wave length	1310-1550 nm		850-1300 nm
Insert loss			
Mean	0.15 dB	0.2 dB	0.10 dB
Standard deviation	1.10 dB	0.12 dB	0.07 dB
Return loss	>50 dB	>65 dB	>20 dB

Insertion Loss against a reference pathcord: IEC 61300-3-4 Method B, also described in ARINC 805
Return Loss: IEC 61300-3-6, also described in ARINC 805

MECHANICAL AND ENVIRONMENTAL CHARACTERISTICS

Test	Standard	LuxCis® Arinc 801 in QuickFusio+ connector
Thermal cycling	SAE AS 13441 method 1003.1	-55°C/+125°C (cable dependent)
Temperature endurance	TIA/EIA 455-11	1000 h @ 125°C (cable dependent)
Vibration	EN2591-403-method B-Level G	27.8 grms
Shocks	EN2591-402	50 grms
Durability	TIA/EIA 364-09	500 cycles
Maintenance ageing	SAE AS 13441 method 2002.1	10 cycles
Cable retention		
1.8 mm diameter	SAE AS 13441 method 2009.1	68 N
900µm diameter	SAE AS 13441 method 2009.1	7 N
Humidity	TIA/EIA 455-5	10 cycles/24 h - 90% RH - + 25°C/+65°C
Salt spray	SAE AS 13441 method 1001.1	96 h
Altitude immersion	TIA/EIA 455-15A	Minimum pressure equivalent to an altitude of 16,764 m (55,000 ft.).

LUXCIS® CONTACT PART NUMBERING SYSTEM



F725: LuxCis® series

Ferrule type

- 00:** PC ferrule for SingleMode fiber
- 03:** PC ferrule for 50/125 or 62,5/125 um MultiMode fiber
- 04:** PC ferrule for 100/40 um MultiMode fiber
- 05:** PC ferrule for 200/230 um MultiMode fiber
- 50:** APC ferrule for SingleMode fiber

Cable type and diameter

- 118:** 900 µm cable
- 318:** 1.2 mm cable with strengthening members, tight structure
- 419:** 1.6 to 2.2 mm cable, loose structure
- 519:** 1.6 to 2.2 mm cable, tight structure

NOTES:

() Mating cycles are dependant on connector series
Radiall can support you with your cable and harness assemblies
Please contact your sales representative

Our Most Important Connection is with You.™

Accessories

ACCESSORIES FOR THREADED OUTPUT SHELLS

The QuickFusio™ series is compatible with a wide range of standard rear accessories.

The threaded output M15 x 1.0-6g has been designed per MIL-DTL-38999 series III size 11 rear dimensions. QuickFusio plug and receptacle connectors are suitable for use with Mil-DTL-38999 series III type backshells.

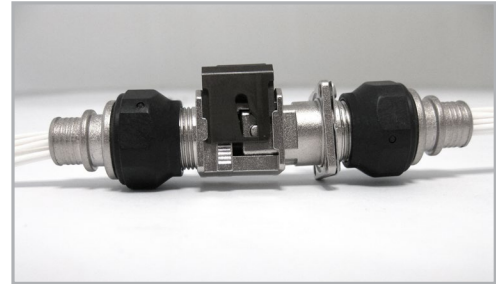

When using F4 and Q1 inserts, refer to page 16 and 17 to check special grommet protrusion.

ACCESSORIES FOR BANDING OUTPUT SHELLS

Band shield terminator			
Radiall part number	Size	Length B	Length C
627990002	Micro	190.5 mm (7.5 inch) - 215.9 mm (8.5 inch)	2.79 mm (.110 inch) - 2.87 mm (.113 inch)

To be used with banding tool A30199

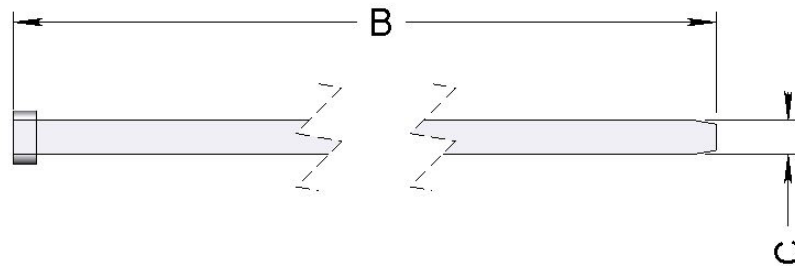



SEALING PLUGS

Sealing plugs are dedicated to environmental inserts

Contact size	Radiall part number	Color	Standard part number
22	616910	black	MS27488-22-2
20	616911	red	MS27488-20-2
16	616912	green	MS27488-16-2
12	616913	orange	MS27488-12-2
8	618915	red	N/A

Spare parts and tools

	Part number	Description
	627954001	Dust cap for plug shell (pink)
	627954002	Dust cap for receptacle shell (pink)
	627954003	ESD dust cap for receptacle shell (black)
	627954004	ESD fly cap for receptacle shell (black)
	627802001	Sleeve Holder for F4 insert
	282549048	Extraction tool for sleeve holder
	670950013	Sealing boot for size 8 quadax contacts cable : NF 24 Q100 and ABS1503KD24
	627990001	Screw Kit (4x UNC 4-40 3A 5/16 screws and 4x washers)
	282690050	Flat screwdriver for slide lock opening FACOM_AN_2.5x50



Our most
important
connection
is with you.™

It's not just a slogan. It's a statement of our earnest desire to put you at the forefront of all our business practices. As part of Radiall's mission to be available and accessible, we make it a priority to have local offices around the globe ready and able to assist you – wherever you are, whenever you need us.

Europe

	ADDRESS	PHONE	FAX	EMAIL
FINLAND	Radiall Finland PO Box 202 - 90101 Oulu	+358 407522412		infofi@radiall.com
FRANCE	Radiall SA 25 Rue Madeleine Vionnet - 93300 Aubervilliers	+33 (0)1 49 35 35 35		info@radiall.com
GERMANY	Radiall GmbH Carl-Zeiss Str. 10 - D 63322 Rödermark	+49 60 74 91 07 0	+49 60 74 91 07 10	infode@radiall.com
ITALY	Radiall Elettronica S.R.L Via Della Resistenza 113 - 20090 Buccinasco Milano	+39 02 48 85 121	+39 02 48 84 30 18	infoit@radiall.com
NETHERLANDS	Radiall Nederland BV Hogebrinkerweg 15b - 3871 KM Hoevelaken	+31 (0)33 253 40 09	+31 (0)33 253 45 12	infofl@radiall.com
SWEDEN	Radiall AB Sollentunavägen 63 - 191 40 Sollentuna	+46 8 444 34 10		infose@radiall.com
UNITED KINGDOM	Radiall Ltd Profile West 950 Great West Rd Brentford, Middlesex TW8 9ES	+44 (0)1895 425000	+44 (0)1895 425010	infouk@radiall.com

Asia

	ADDRESS	PHONE	FAX	EMAIL
CHINA	Shanghai Radiall Electronics CO, Ltd N° 390 Yong He Rd SHANGHAI 200072 P.R.C	+86 21 66523788	+86 21 66521177	infozh@radiall.com
HONG KONG	Radiall Electronics (Asia) Ltd Flat D, 6/F, Ford Glory Plaza, 37-39 Wing Hong Street - Cheung Sha Wan - Kowloon - Hong Kong	+852 29593833	+852 29592636	infohk@radiall.com
INDIA	Radiall India Pvt. Ltd 25.D.II phase Peenya Industrial Area. Bangalore-560058	+91 80 283 95 271	+91 80 283 97 228	infoin@radiall.com
JAPAN	Nihon Radiall Shibuya-Ku Ebisu 1-5-2, Kougetsu Bldg 405 - Tokyo 150-0013	+81 3 34406241	+81 3 34406242	infojp@radiall.com

Americas

	ADDRESS	PHONE	FAX	EMAIL
USA & CANADA	Radiall USA, Inc. 8950 South 52nd Street Ste 401 Tempe, AZ 85284	+1 480-682-9400	+1 480-682-9403	infousa@radiall.com

Also Represented In...

AUSTRALIA AUSTRIA BELGIUM BRAZIL CZECH REPUBLIC DENMARK ESTONIA GREECE HUNGARY INDONESIA ISRAEL KOREA LATVIA LITHUANIA
MALAYSIA NORWAY PHILIPPINES POLAND PORTUGAL RUSSIA SINGAPORE SPAIN SWITZERLAND TAIWAN THAILAND VIETNAM SOUTH AFRICA

X-ON Electronics

Largest Supplier of Electrical and Electronic Components

Click to view similar products for [Circular MIL Spec Connector](#) category:

Click to view products by [Radiall](#) manufacturer:

Other Similar products are found below :

[0025-262-542](#) [0025-264-3014](#) [58-570121-04S](#) [0134-202-1200](#) [0134-207-1206](#) [0134-207-1800](#) [0134-207-2207](#) [0134-213-0806](#) [0134-213-1007](#) [0134-213-1009](#) [0134-213-1208](#) [0134-213-1800](#) [0134-213-2209](#) [0025-258-000](#) [015-9516-002](#) [60-042217-10P](#) [60-042722-19P](#) [0114-201-1278](#) [602GB06EG24-61SN](#) [0134-201-1207](#) [0134-201-1806](#) [0134-201-2006](#) [0134-201-2007](#) [0134-201-2010](#) [0134-202-1400](#) [0134-207-0809](#) [0134-207-1208](#) [0134-207-2009](#) [0134-213-1006](#) [6104-207-2302](#) [6104-208-1902](#) [6104-215-0902](#) [6131-202-19149P](#) [6131-204-21149P](#) [6131-207-13149P](#) [6131-208-13149P](#) [6131-209-17149P](#) [6131-210-11149P](#) [6131-211-19149P](#) [6131-216-19149P](#) [6131-220-25149P](#) [6131-259-11149P](#) [6131-259-21149P](#) [6131-259-23149P](#) [6131-263-19149P](#) [6131-265-17149P](#) [6131-265-19149P](#) [CS3102A-20-15P](#) [CS3102A-20-15S](#) [CS3102A-28-15S](#)