

RIGHT ANGLE H2 RECEPTACLE SMT TYPE

R107.003.010

REEL 100

Series : UMP

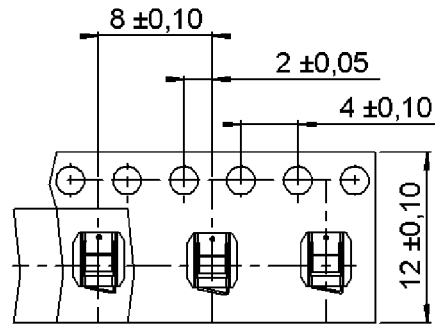
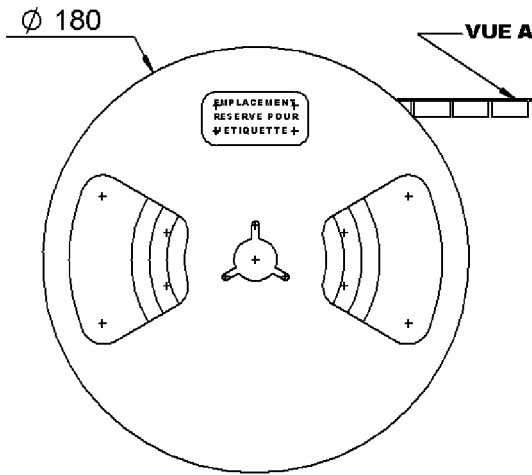

VUE A / VIEW A

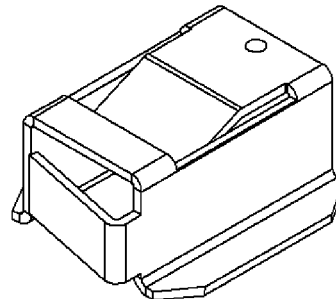
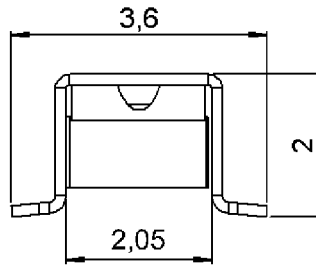
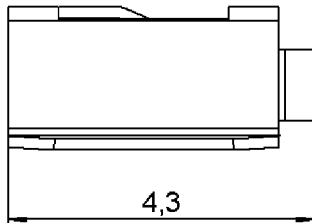

SCALE: 1/1

All dimensions are in mm.



COMPONENTS	MATERIALS	PLATINGS (µm)
BODY	BERYLLIUM COPPER	GOLD 0.2 OVER NICKEL 2
CENTER CONTACT	-	-
OUTER CONTACT	-	-
INSULATOR	-	-
GASKET	-	-
OTHERS PARTS	-	-
-	-	-
-	-	-

Issue : 0415 A

In the effort to improve our products, we reserve the right to make changes judged to be necessary.



RIGHT ANGLE H2 RECEPTACLE SMT TYPE

R107.003.010

REEL 100

Series : UMP

PACKAGING

SPECIFICATION

Standard	Unit	Other
100	'W' option	Contact us

ELECTRICAL CHARACTERISTICS

ENVIRONMENTAL

Impedance		50 Ω
Frequency		0-6 GHz
VSWR	1.05 +	0.030 x F(GHz) Maxi
Insertion loss		NA √F(GHz) dB Maxi
RF leakage	- (NA - F(GHz)) dB Maxi
Voltage rating		100 Veff Maxi
Dielectric withstanding voltage		350 Veff mini
Insulation resistance		1000 MΩ mini

Operating temperature	-40/+125 ° C
Hermetic seal	NA Atm.cm3/s
Panel leakage	NA

OTHERS CHARACTERISTICS

Assembly instruction

Others :

-

MECHANICAL CHARACTERISTICS

Center contact retention		
Axial force – Mating end		NA N mini
Axial force – Opposite end		NA N mini
Torque		NA N.cm mini
Recommended torque		
Mating		NA N.cm
Panel nut		NA N.cm
Mating life		100 Cycles mini
Weight		0.035 g

Issue : 0415 A

In the effort to improve our products, we reserve the right to make changes judged to be necessary.



RIGHT ANGLE H2 RECEPTACLE SMT TYPE

R107.003.010

REEL 100

Series : UMP

**SOLDER PROCEDURE OF UMP RECEPTACLE
IN INDUSTRIAL ENVIRONMENT**

1. Deposit solder paste 'Sn Ag4 Cu0.5' on mounting zone by screen printing application. We recommend a low residue flux.
We advise a thickness of 150 micromm (5.850 microinch). Verify that the edges of the zone are clean.
2. Placement of the receptacle on the mounting zone with an automatic machine of 'pick and place' type.
A video camera is recommended for positioning of the component.
Adhesive agents must not be used on the receptacle.
3. This process of soldering has been tested with convection oven.
Below please find, the typical profile to use.
4. The cleaning of printed circuit boards is not obliged.
5. Verification of solder joints and position of the component by visual inspection.

NOTE : THE UMP RECEPTACLE AND THE UMP PLUG MUST NOT BE MATED BEFORE COMPLETION OF THIS PROCEDURE.

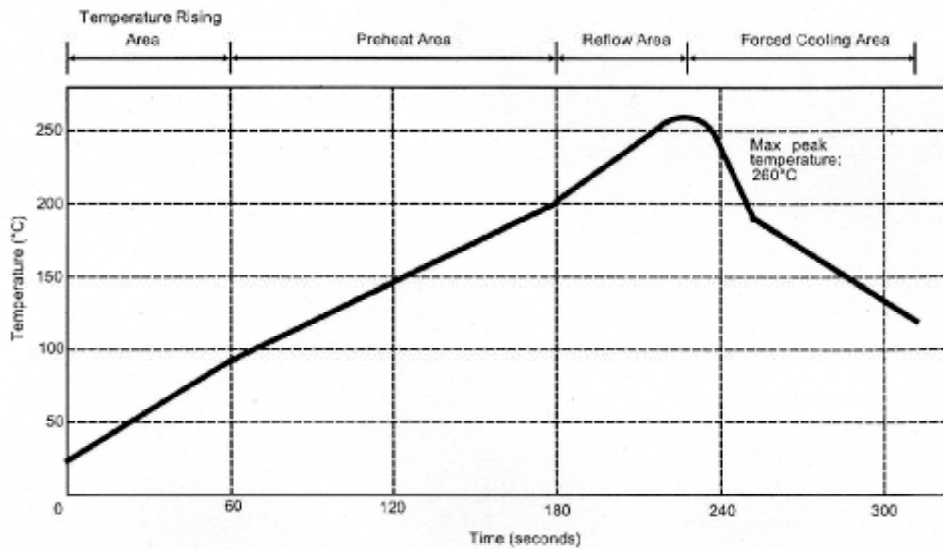

Parmeter	Value	Unit
Temperature rising Area	1 - 4	°C/sec
Max Peak Temperature	260	°C
Max dwell time @260°C	10	sec
Min dwell time @235°C	20	sec
Max dwell time @235°C	60	sec
Temperature drop in cooling Area	-1 to - 4	°C/sec
Max dwell time above 100°C	420	sec

Issue : 0415 A

In the effort to improve our products, we reserve the right to make changes judged to be necessary.



RIGHT ANGLE H2 RECEPTACLE SMT TYPE

R107.003.010

REEL 100

Series : UMP



UMP SERIES INFORMATION

PCB

COPLANAR LINE

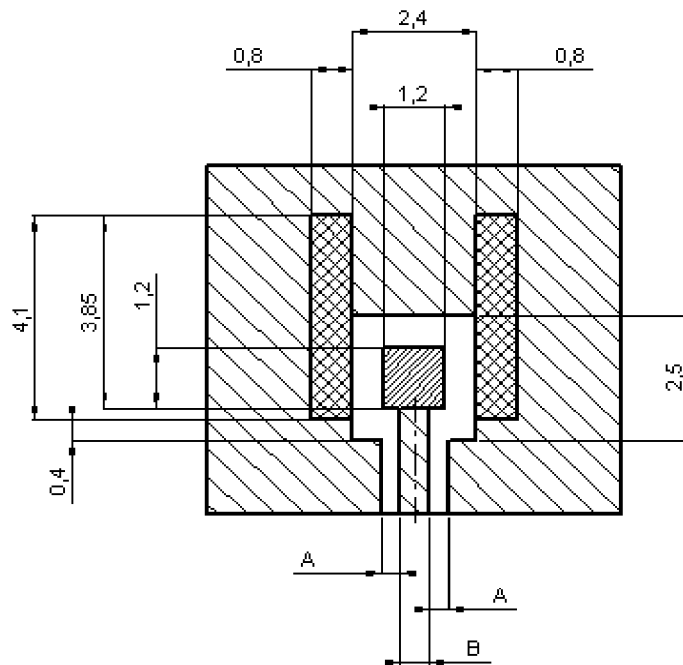
Ground and signal are on the same side
The material of PCB is glass is glass-epoxy Composite.



-  Gold over nickel for solder paste
-  Gold over nickel contact area free of any surface contaminant
-  Ground + varnish

APPLICATION 75Ω
WITH B = 0,55mm

PCB thickness (mm)	Coplanar ligne A (mm)
0,8	0,57
1,0	0,45
1,2	0,41
1,6	0,37

APPLICATION 50Ω
WITH B = 1,2mm

PCB thickness (mm)	Coplanar ligne A (mm)
0,8	0,183
1,0	0,190
1,2	0,195
1,6	0,20

Issue : 0415 A

In the effort to improve our products, we reserve the right to make changes judged to be necessary.



RIGHT ANGLE H2 RECEPTACLE SMT TYPE

R107.003.010

REEL 100

Series : UMP

UMP SERIES INFORMATION

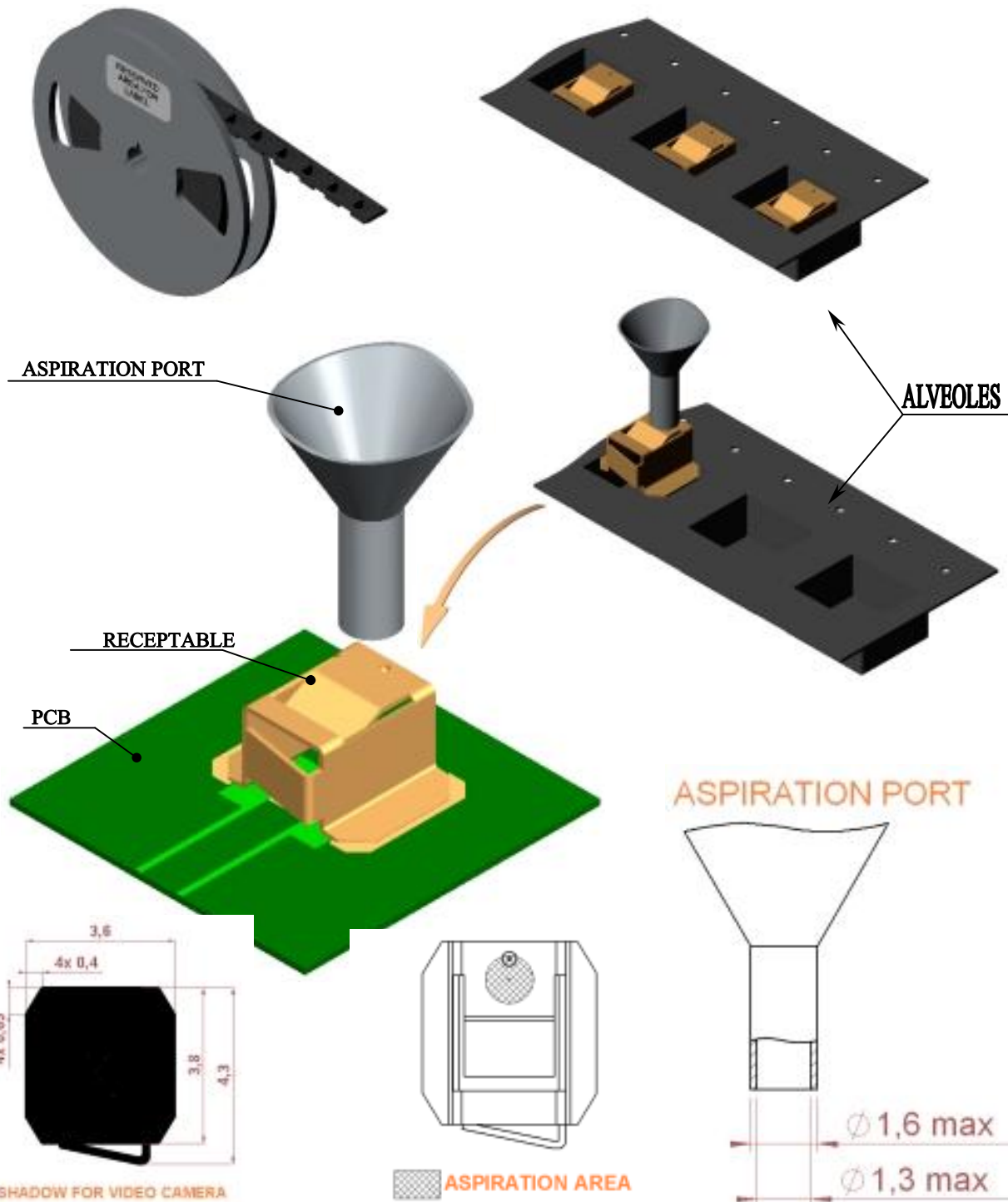

Issue : 0415 A

In the effort to improve our products, we reserve the right to make changes judged to be necessary.



RIGHT ANGLE H2 RECEPTACLE SMT TYPE

R107.003.010

REEL 100

Series : UMP

UMP CONNECTING NOTE

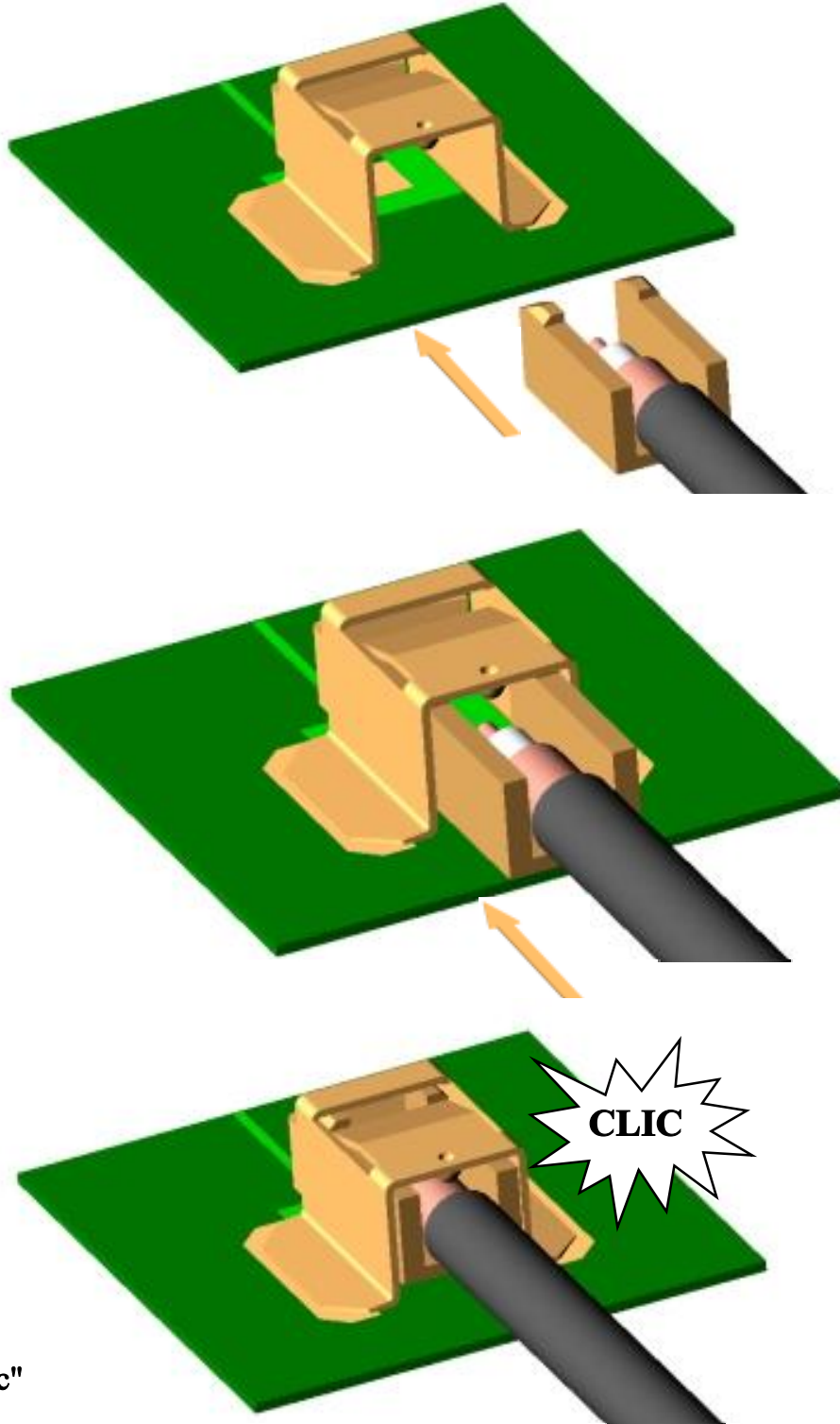

Do not push
over the "clik"

Issue : 0415 A

In the effort to improve our products, we reserve the right to make changes judged to be necessary.



RADIALL®

RIGHT ANGLE H2 RECEPTACLE SMT TYPE

R107.003.010

REEL 100

Series : UMP

UMP NOTE CONNECTING

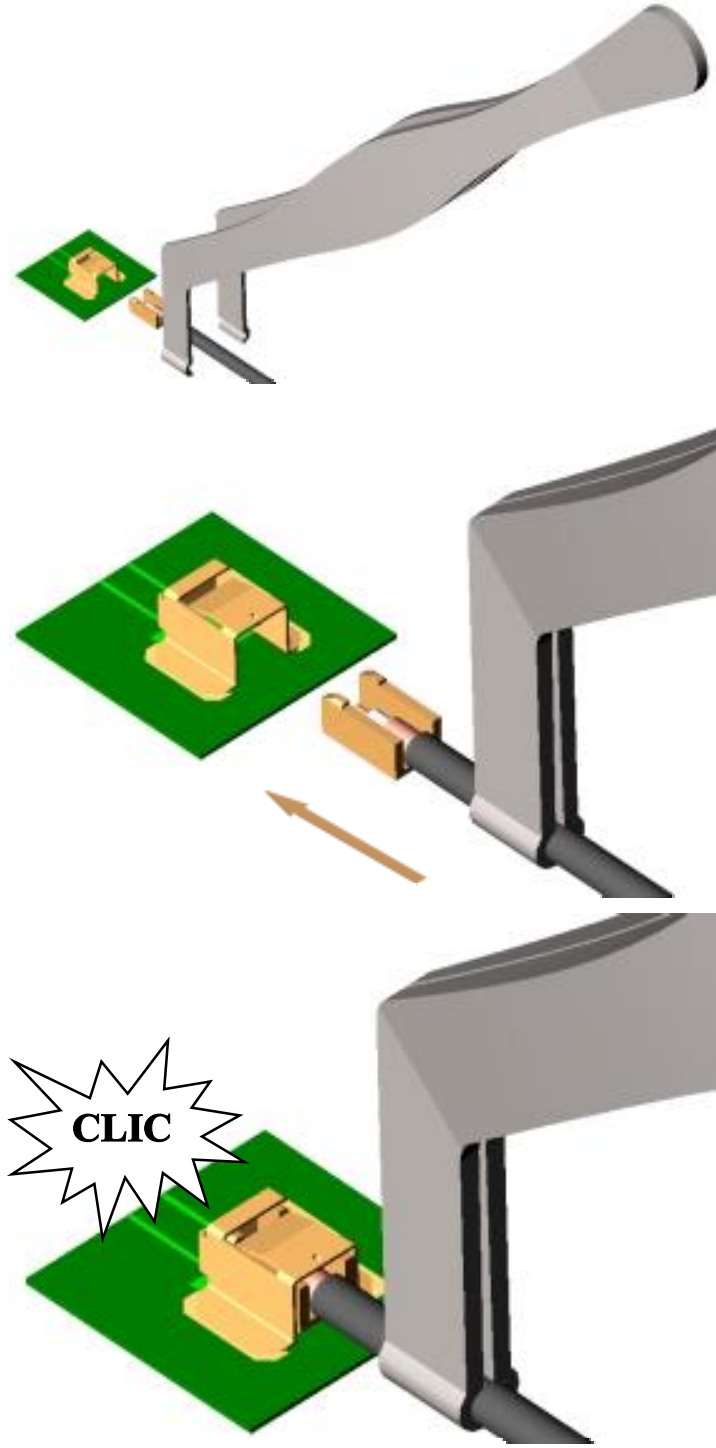

Do not push over the «clac»

Issue : 0415 A

In the effort to improve our products, we reserve the right to make changes judged to be necessary.



RIGHT ANGLE H2 RECEPTACLE SMT TYPE

R107.003.010

REEL 100

Series : UMP

UMP DISCONNECTING NOTE

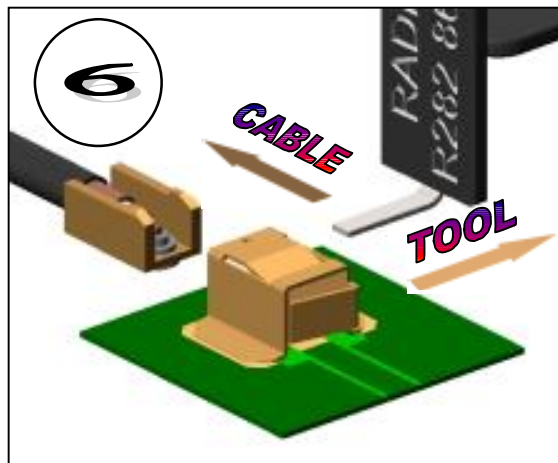
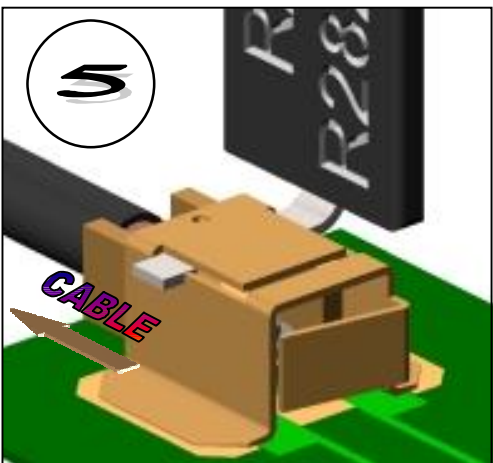
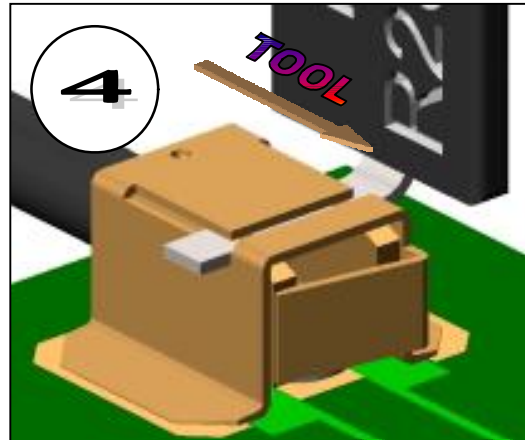
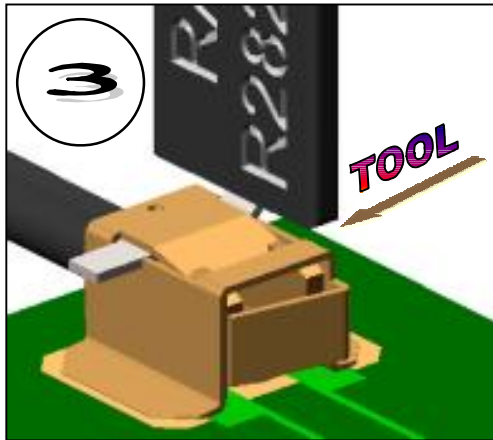
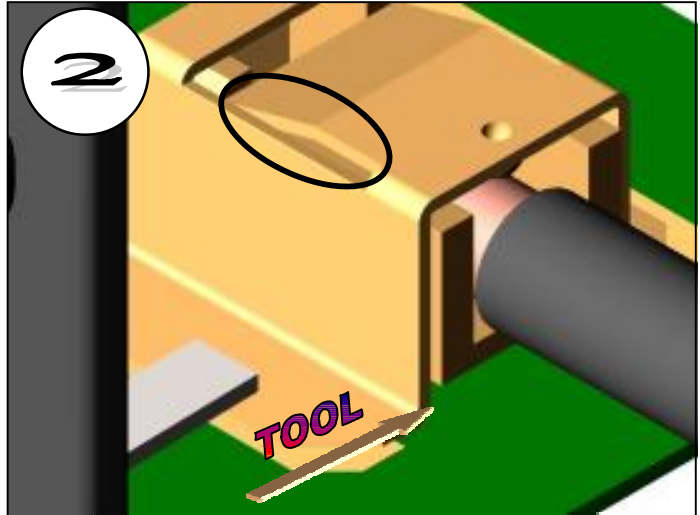
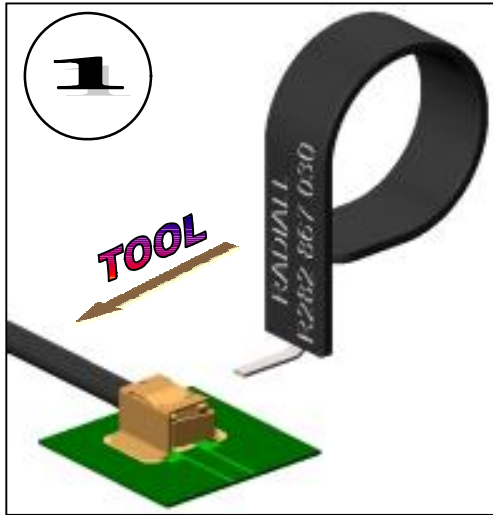

Issue : 0415 A

In the effort to improve our products, we reserve the right to make changes judged to be necessary.



X-ON Electronics

Largest Supplier of Electrical and Electronic Components

Click to view similar products for [RF Connectors / Coaxial Connectors](#) category:

Click to view products by [Radiall](#) manufacturer:

Other Similar products are found below :

[8915-1511-000](#) [89674-0827](#) [6001-7071-019](#) [6002-7051-003](#) [6002-7551-202](#) [6059674-1](#) [619550-1](#) [630059-000](#) [M39030/3-01N](#) [6500-7071-046](#) [6769](#) [CX050L2AQ](#) [7002-1541-010](#) [7002-1542-011](#) [7004-1512-000](#) [7009-1511-004](#) [7010-1511-000](#) [7029-1511-060](#) [7101-1541-010](#) [7101-1571-002](#) [7145-1521-002](#) [7203-1571-003](#) [7209-1511-011](#) [7210-1511-015](#) [7210-1511-019](#) [73137-5015](#) [73216-2241](#) [73404-2300](#) [7405-1521-005](#) [7405-1521-802](#) [8527](#) [8547](#) [FS11V](#) [877931](#) [8808-1511-001](#) [9074-9513-000](#) [9101-9573-002](#) [910A205F](#) [9130-9573-002](#) [PL11SC-026](#) [PL375-33](#) [PL40-5](#) [PL74C-221](#) [PL75MC-217](#) [PL803-7](#) [1200690078](#) [1-201144-1](#) [R107003010W](#) [R110A172100](#) [R112186000](#)