

**STRAIGHT PLUG FULL CRIMP-TYPE
CABLE 5/50 D**

R124.076.323
SERIES SMA-COM

Hex. .315/flats
(Hex. 8/plats)

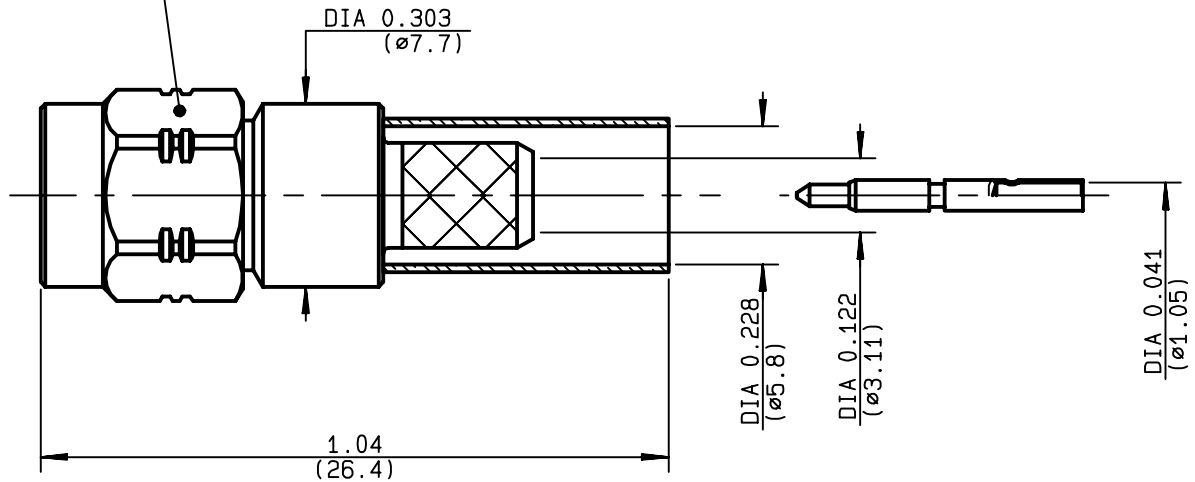

NOMINAL IMPEDANCE	50 Ω
FREQUENCY RANGE	0-12.4 GHz
TEMPERATURE RATING	-65/+165 °C
V.S.W.R	1.15 + .01 x F(GHz)Maxi
RF INSERTION LOSS	0.05 √F(GHz) dB Maxi
VOLTAGE RATING	335 Veff Maxi
DIELECTRIC WITHSTANDING VOLTAGE	1000 Veff Mini
INSULATION RESISTANCE	5000 MΩMini
HERMETIC SEAL	NA Atm.cm ³ /s
LEAKAGE (pressurized only)	NA
MECHANICAL DURABILITY	100 Cycles
WEIGHT	4.9 gr
SPECIFICATION	

CABLES : **KX 23**
RG 142
RG 142 FTX
RG 223
RG 400

OTHERS CHARACTERISTICS

CABLE RETENTION	204 N Mini
CENTER CONTACT RETENTION	
Axial force - mating end	18 N Mini
Axial force - opposite end	18 N Mini
Torque	NA cm.N Mini
RECOMMENDED TORQUES	
Mating	60 cm.N
Panel nut	NA cm.N
Clamp nut	NA cm.N

CONNECTOR PARTS MATERIALS

BODY	BRASS
OUTER CONTACT	
CENTER CONTACT	BRASS
INSULATOR	PTFE
GASKET	
OTHERS PIECES	BRASS

FINISH (all values are given in micrometers)

BODY	GOLD 0.2 OVER NICKEL 2
OUTER CONTACT	
CENTER CONTACT	GOLD 1.3 OVER COPPER 2.5
INSULATOR	-
GASKET	-
OTHERS PIECES	GOLD 0.2 OVER NICKEL 2

TRIQUES

ISSUE	CREATION DATE	FILE PART-NUMBER
9847B00	20/05/1996	96-1000-053



RADIALL®

The information given here is subject to change without notice.
Design changes may be in order to improve the product .

Connect to the future



R124.076.323

ISSUE 9847B00 SERIES SMA-COM

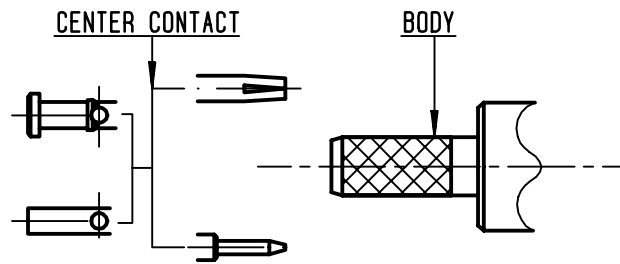
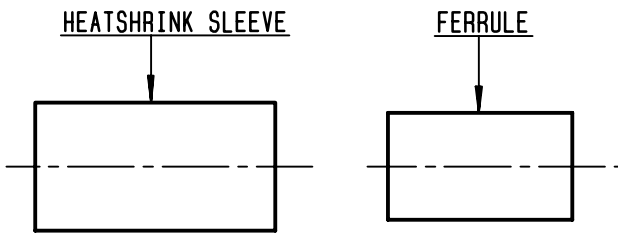

①

Slide heatshrink sleeve (R280.637.030-Option) and ferrule onto cable. Strip the cable.

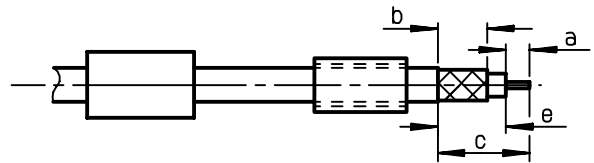

Stripping	a	b	c	d	e
inch	0.118	0.248	0.425	0	0.307
mm	3	6.3	10.8		7.8

②

Slide center contact on until it bottoms against cable dielectric. Solder or crimp center contact. Crimping tool : R282.281.000 (2 x 4 pts) position 7 + positionner R282.967.012.

SOLDER / CRIMPING

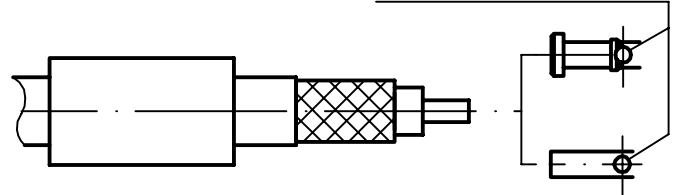

③

Fan the braid. Slide cable into the body by overtaking the insulator hard mounting point. Slide ferrule over the braid. (In direction F)

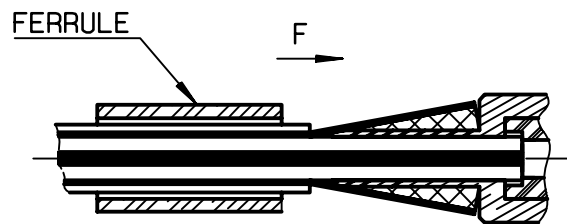

④

Crimp the ferrule with crimping tool R282.223.000 (Hex. : .213)(5.41) or crimping tool R282.293.000 (M22520/5-01) + dies R282.235.011 (M22520/5-11) Cut excess of braid if necessary. Slide sleeve over ferrule and heatshrink in place (Option)

Shrink the heatshrink sleeve

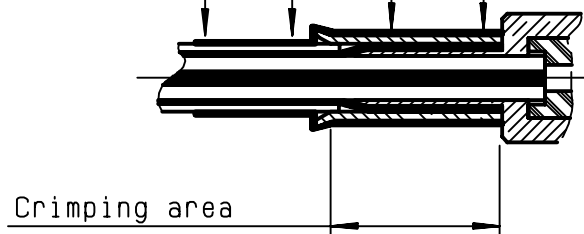

TRIQUES

X-ON Electronics

Largest Supplier of Electrical and Electronic Components

Click to view similar products for [RF Connectors / Coaxial Connectors](#) category:

Click to view products by [Radiall](#) manufacturer:

Other Similar products are found below :

[8915-1511-000](#) [89674-0827](#) [6001-7071-019](#) [6002-7051-003](#) [6002-7551-202](#) [6059674-1](#) [619550-1](#) [630059-000](#) [M39030/3-01N](#) [6500-7071-046](#) [6769](#) [CX050L2AQ](#) [7002-1541-010](#) [7002-1542-011](#) [7004-1512-000](#) [7009-1511-004](#) [7010-1511-000](#) [7029-1511-060](#) [7101-1541-010](#) [7101-1571-002](#) [7145-1521-002](#) [7203-1571-003](#) [7209-1511-011](#) [7210-1511-015](#) [7210-1511-019](#) [73137-5015](#) [73216-2241](#) [73404-2300](#) [7405-1521-005](#) [7405-1521-802](#) [8527](#) [8547](#) [FS11V](#) [877931](#) [8808-1511-001](#) [9049-9513-000](#) [9074-9513-000](#) [9101-9573-002](#) [910A205F](#) [9130-9573-002](#) [PL11SC-026](#) [PL375-33](#) [PL40-5](#) [PL74C-221](#) [PL75MC-217](#) [PL803-7](#) [980-8666-005](#) [1200690078](#) [1-201144-1](#) [R107003010W](#)