

**STRAIGHT JACK FULL CRIMP TYPE
CABLE 2.6/50 S**

R124.236.123
SERIES SMA-COM

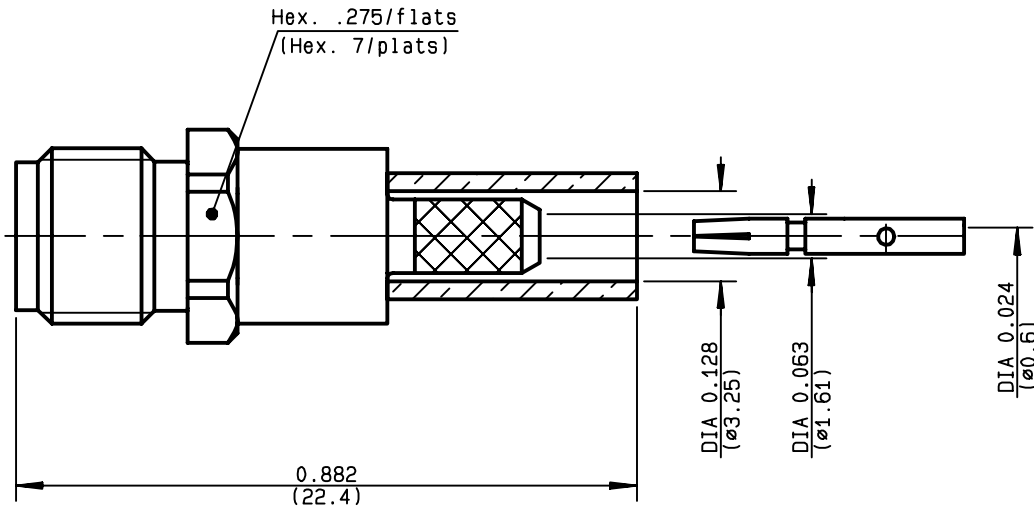

NOMINAL IMPEDANCE	50 Ω
FREQUENCY RANGE	0-12.4 GHz
TEMPERATURE RATING	-65/+165 °C
V.S.W.R	1.15 + .02 x F(GHz)Maxi
RF INSERTION LOSS	0.05 √F(GHz) dB Maxi
VOLTAGE RATING	250 Veff Maxi
DIELECTRIC WITHSTANDING VOLTAGE	750 Veff Mini
INSULATION RESISTANCE	5000 MΩMini
HERMETIC SEAL	NA Atm.cm ³ /s
LEAKAGE (pressurized only)	NA
MECHANICAL DURABILITY	100 Cycles
WEIGHT	2.7 gr
SPECIFICATION	

CABLES : **KX 22A**
RG 188
RG 316

OTHERS CHARACTERISTICS

CABLE RETENTION	90 N Mini
CENTER CONTACT RETENTION	
Axial force - mating end	18 N Mini
Axial force - opposite end	18 N Mini
Torque	NA cm.N Mini
RECOMMENDED TORQUES	
Mating	NA cm.N
Panel nut	NA cm.N
Clamp nut	NA cm.N

CONNECTOR PARTS	MATERIALS	FINISH
BODY	BRASS	GOLD 0.2 OVER NICKEL 2
OUTER CONTACT		
CENTER CONTACT	BERYLLIUM COPPER	GOLD 1.3 OVER COPPER 2.5
INSULATOR	PTFE	-
GASKET		-
OTHERS PIECES	BRASS	GOLD 0.2 OVER NICKEL 2

(all values are given in micrometers)

TRIQUES

ISSUE	CREATION DATE	FILE PART-NUMBER
9847A00	02/12/1996	96-1200-133



RADIALL®

The information given here is subject to change without notice.
Design changes may be in order to improve the product .

Connect to the future



R124.236.123

ISSUE 9847A00 SERIES SMA-COM

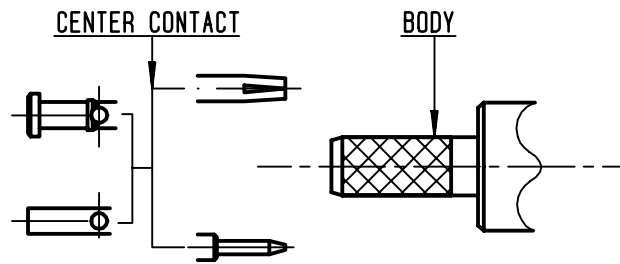
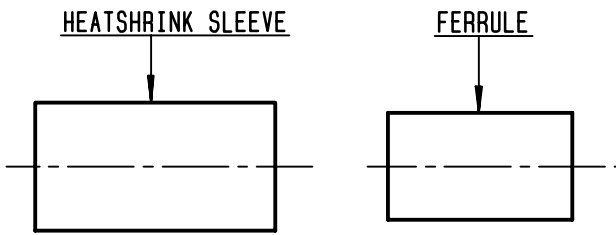

①

Slide heatshrink sleeve (R280.637.020-Option) and ferrule onto cable. Strip the cable.

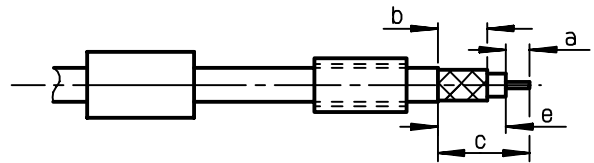

Stripping	a	b	c	d	e
inch	0.118	0.248	0.425	0	0.307
mm	3	6.3	10.8		7.8

②

Slide center contact on until it bottoms against cable dielectric. Solder or crimp center contact. Crimping tool : R282.281.000 (2 x 4 pts) position 5 + positionner R282.967.012.

SOLDER / CRIMPING

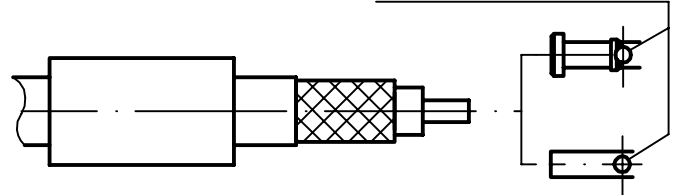

③

Fan the braid. Slide cable into the body by overtaking the insulator hard mounting point. Slide ferrule over the braid. (In direction F)

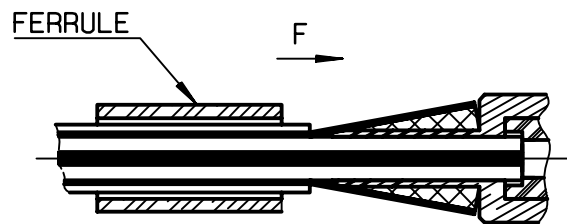

④

Crimp the ferrule with crimping tool R282.271.000 (Hex. : .128)(3.25) or crimping tool R282.293.000 (M22520/5-01) + dies R282.235.003 (M22520/5-03) Cut excess of braid if necessary. Slide sleeve over ferrule and heatshrink in place (Option)

Shrink the heatshrink sleeve

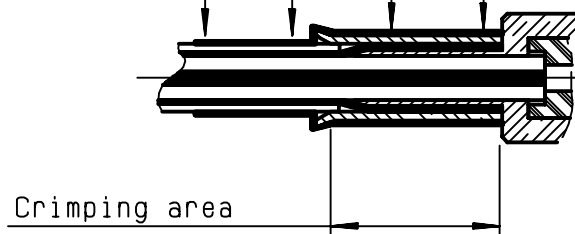

X-ON Electronics

Largest Supplier of Electrical and Electronic Components

Click to view similar products for [RF Connectors](#) / [Coaxial Connectors](#) category:

Click to view products by [Radiall](#) manufacturer:

Other Similar products are found below :

[8915-1511-000](#) [89674-0827](#) [6001-7071-019](#) [6002-7051-003](#) [6002-7551-202](#) [6059674-1](#) [619550-1](#) [630059-000](#) [M39030/3-01N](#) [6500-7071-046](#) [6769](#) [CX050L2AQ](#) [7002-1541-010](#) [7002-1542-011](#) [7004-1512-000](#) [7009-1511-004](#) [7010-1511-000](#) [7029-1511-060](#) [7101-1541-010](#) [7101-1571-002](#) [7145-1521-002](#) [7203-1571-003](#) [7209-1511-011](#) [7210-1511-015](#) [7210-1511-019](#) [73137-5015](#) [73216-2241](#) [73404-2300](#) [7405-1521-005](#) [7405-1521-802](#) [8527](#) [8547](#) [FS11V](#) [877931](#) [8808-1511-001](#) [9074-9513-000](#) [9101-9573-002](#) [910A205F](#) [9130-9573-002](#) [PL11SC-026](#) [PL375-33](#) [PL40-5](#) [PL74C-221](#) [PL75MC-217](#) [PL803-7](#) [1200690078](#) [1-201144-1](#) [R107003010W](#) [R110A172100](#) [R112186000](#)