

**STRAIGHT BULKHEAD JACK FULL CRIMP TYPE  
CABLE 5/50 D**

**R125.315.120  
SERIES SMA**

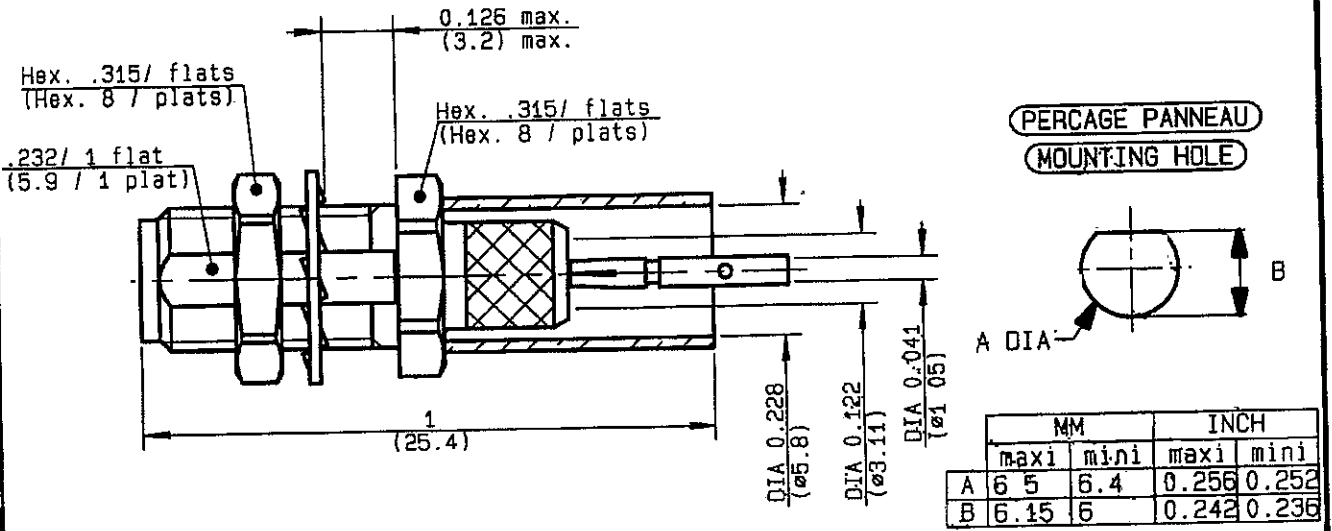

NOMINAL IMPEDANCE	<b>50</b> Ω
FREQUENCY RANGE	<b>0-12.4</b> GHz
TEMPERATURE RATING	<b>-65/+165</b> °C
V.S.W.R	<b>1.15 + .01</b> x F(GHz)Maxi
RF INSERTION LOSS	<b>0.04</b> √F(GHz) dB Maxi
VOLTAGE RATING	<b>335</b> Veff Maxi
DIELECTRIC WITHSTANDING VOLTAGE	<b>1000</b> Veff Mini
INSULATION RESISTANCE	<b>5000</b> MΩMini
HERMETIC SEAL	<b>NA</b> Atm.cm <sup>3</sup> /s
LEAKAGE (pressurized only)	<b>NA</b>
MECHANICAL DURABILITY	<b>500</b> Cycles
WEIGHT	<b>3.8</b> gr
SPECIFICATION	

CABLES	<b>KX 23</b>
	<b>RE 142</b>
	<b>RE 142 FILX</b>
	<b>RE 223</b>
	<b>RE 400</b>
OTHERS CHARACTERISTICS	
CABLE RETENTION	<b>204</b> N Mini
CENTER CONTACT RETENTION	
Axial force - mating end	<b>18</b> N Mini
Axial force - opposite end	<b>18</b> N Mini
Torque	<b>NA</b> cm.N Mini
RECOMMENDED TORQUES	
Mating	<b>NA</b> cm.N
Panel nut	<b>150</b> cm.N
Clamp nut	<b>NA</b> cm.N

CONNECTOR PARTS	MATERIALS	FINISH	(all values are given in micrometers)
BODY	STAINLESS STEEL	GOLD 0.5 OVER NICKEL 2	
OUTER CONTACT			
CENTER CONTACT	BERYLLIUM COPPER	GOLD 1.3 OVER NICKEL 2	
INSULATOR	PTFE	-	
GASKET		-	
OTHERS PIECES	BRASS	GOLD 0.2 OVER NICKEL 2	

ISSUE <b>9836A00</b>	CREATION DATE <b>04-SEP-98</b>	FILE PART-NUMBER <b>96-1000-057</b>	 <b>RADIALL®</b>
-------------------------	-----------------------------------	--	--

The information given here is subject to change without notice.  
Design changes may be in order to improve the product .

*Connect to the future*



**RADIALL®**

**R125.315.120**

ISSUE 9836A00 SERIES SMA

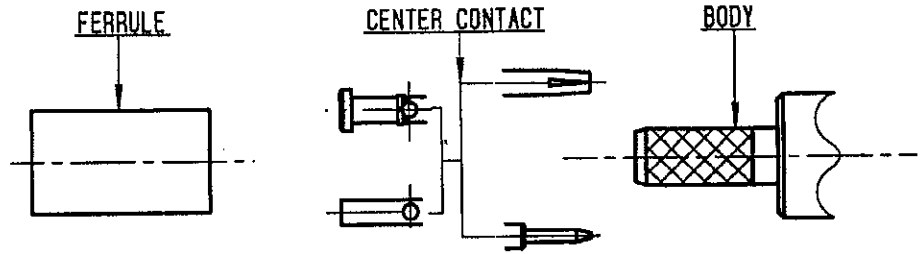

①

Slide onto the cable the ferrule .  
Strip the cable .

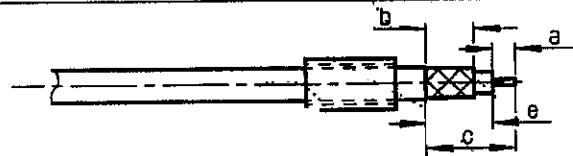

Stripping	a	b	c	d	e
inch	0.118	0.248	0.425	0	0.307
mm	3	6.3	10.8		7.8

②

Slide center contact on until it bottoms against cable dielectric  
Solder or crimp center contact .  
Crimping tool R282.281.000 ( 2 x 4 pts )  
position 7 + positionner R282.967.012

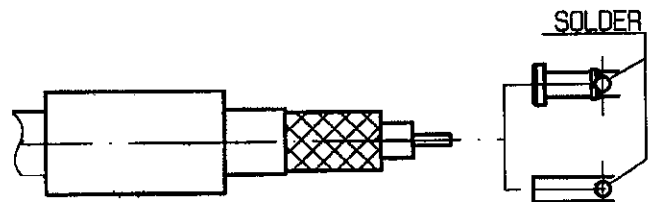

③

Fan the braid  
Slide cable into the body by overtaking the insulator hard mounting point  
Slide ferrule over the braid  
(In direction F)

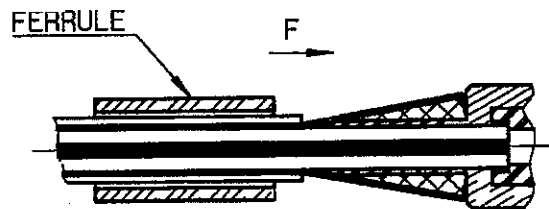

④

Crimp the ferrule with crimping tool R 282 223 000 ( Hex. : .213 ) or crimping tool R 282 293 000 ( M22520/5-01 ) + dies R 282 235 011 ( M22520/5-11 )  
Cut the excess of braid if necessary.

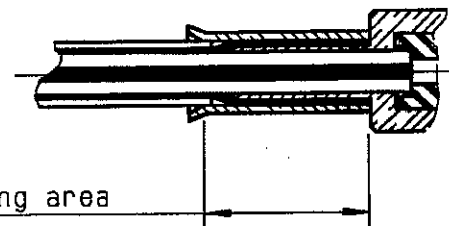

Crimping area

LELEU

## X-ON Electronics

Largest Supplier of Electrical and Electronic Components

*Click to view similar products for [RF Connectors](#) / [Coaxial Connectors](#) category:*

*Click to view products by [Radiall](#) manufacturer:*

Other Similar products are found below :

[8915-1511-000](#) [89674-0827](#) [6001-7071-019](#) [6002-7051-003](#) [6002-7551-202](#) [6059674-1](#) [619550-1](#) [630059-000](#) [M39030/3-01N](#) [6500-7071-046](#) [6769](#) [CX050L2AQ](#) [7002-1541-010](#) [7002-1542-011](#) [7004-1512-000](#) [7009-1511-004](#) [7010-1511-000](#) [7029-1511-060](#) [7101-1541-010](#) [7101-1571-002](#) [7145-1521-002](#) [7203-1571-003](#) [7209-1511-011](#) [7210-1511-015](#) [7210-1511-019](#) [73137-5015](#) [73216-2241](#) [73404-2300](#) [7405-1521-005](#) [7405-1521-802](#) [8527](#) [8547](#) [FS11V](#) [877931](#) [8808-1511-001](#) [9074-9513-000](#) [9101-9573-002](#) [910A205F](#) [9130-9573-002](#) [PL11SC-026](#) [PL375-33](#) [PL40-5](#) [PL74C-221](#) [PL75MC-217](#) [PL803-7](#) [1200690078](#) [1-201144-1](#) [R107003010W](#) [R110A172100](#) [R112186000](#)