

SMA / SMA-COM / SMA 2.9 series

R124 / R125 / R127

RADIALL 
The next connexion

	Pages
SMA	
Introduction	8-4 to 8-6
Interface	8-7
Characteristics	8-8 to 8-9
Straight plugs	8-9 to 8-10
Right angle plugs	8-11
Straight jacks	8-12
Bulkhead jacks	8-13
Receptacles	8-14 to 8-17
Receptacles for microstrip	8-18 to 8-21
Hermetic receptacles with separate glass bead	8-22
Hermetic receptacles with integrated glass bead	8-22 to 8-23
Hermetic receptacles without glass bead	8-23
Adapters	8-24
Accessories	8-25
Glass beads and accessories for hermetic receptacles	8-26 to 8-27
Panel drilling	8-27 to 8-29
Tooling for hermetic receptacles	8-29
Field replaceable hermetic microstrip receptacle information	8-30 to 8-31
SMA-COM	
Introduction	8-32 to 8-33
Interface	8-34
Characteristics	8-35
Plugs	8-36 to 8-37
Jacks	8-37 to 8-38
Receptacles	8-39 to 8-41
Adapters	8-42
Panel drilling	8-42
Packaging	8-43
Assembly instructions	8-43 to 8-44
SMA 2.9	
Introduction	8-45
Interface	8-46
Characteristics	8-47
Plugs	8-47
Jacks	8-48
Receptacles	8-48
Glass bead	8-49
In series adapters	8-49
Between series adapters	8-50
Panel drilling	8-50

INTRODUCTION

The RADIALl stainless steel SMA connectors have been designed for applications where reliability, durability, robustness and high frequency are very important.

• WIDE RANGE:

The stainless steel SMA range offers cable connectors for both flexible or semi-rigid cables, panel and PCB mount receptacles, press mount, microstrip, universal, through hole pins and end launch connectors. In series adapters and between series adapters including PUSH-ON interface are also available.

All our stainless steel SMA connectors can be mated with our commercial (brass) SMA connectors.

• CONVENIENT 3-PIECE DESIGN ON MOST CONNECTORS FOR FLEXIBLE CABLES:

- for straight models: single piece body + center contact + outer ferrule,
- for right angle models: single piece body + cap + outer ferrule.

• FAST AND RELIABLE CABLE ATTACHMENT:

The cable connectors can be either fully crimped or soldered/crimped, offering full flexibility for high volume production with standard manual or pneumatic tooling: fast and reliable.

- the center contact can be either crimped or soldered,
- the outer contact is attached to the cable by crimping a ferrule.

• SIMPLE SNAP-IN CENTER CONTACT CAPTIVATION (FOR FULL CRIMP MODELS):

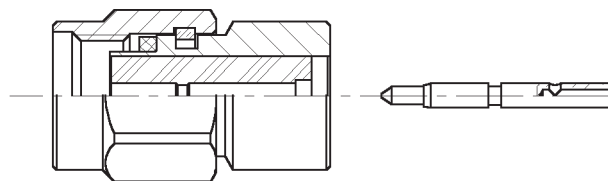

The relative position of the center contact into the interface is mechanically guaranteed by the snapping of the insulator inner shoulder into the groove of the center contact.

This design facilitates the captivation operation in contrast of other designs, requiring 2 insulators to provide contact retention.

• EXTENDED FREQUENCY SMA DC-27 GHz

Radiall offers an extended frequency SMA range allowing coaxial system operation up to 27 GHz. This series mates with the standard SMA series and maintains the same mechanical characteristics (part numbers ending with 700, 701 or 702).

• SOLDERLESS ATTACHMENT TO SEMI-RIGID CABLE

Radiall's SMA crimp connector series offers an exciting alternative for assembling SMA connectors to semi-rigid cable. The main advantages of these connectors are: time saving, repeatability and performance.



• SMA HERMETIC

Hermetic connectors are required to maintain a pressurised or vacuum environment inside a micro-electronic package. Radiall offers 3 types of hermetic connectors:

1. Field replaceable hermetic receptacles with separate glass bead

(leakage rate below 10^{-8} atm/cm³/sec)

The hermeticity level is guaranteed by the glass bead soldered into the package. A large choice of glass beads is available from dia 0.3 to 0.5 mm. They are usually ordered separately from the receptacle. The receptacle can be removed (field replaceable) from the package for maintenance without any risk of leakage. The field replaceable receptacle is recommended when a high number of matings is required.

2. Hermetic receptacles with integrated glass bead

(leakage rate below 10^{-8} atm/cm³/sec)

The glass bead is already in place inside the receptacle, hermeticity is guaranteed by a solder joint between the receptacle and the package or with a metallic compression gasket.

Screw-on receptacle with metallic compression gasket offer superior climatic resistance: -65°C +200°C.

3. Hermetic receptacles without glass bead

(leakage rate below 10^{-6} atm/cm³/sec)

A good hermeticity level is obtained with a metallic gasket at a cost advantage vs glass beads.

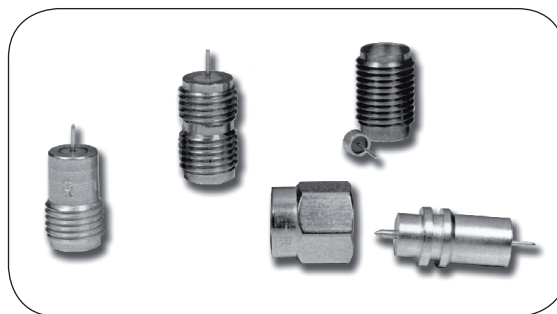

INTRODUCTION



50Ω

DC - 18 GHz
DC - 27 GHz**GENERAL**

- Sub-miniature coaxial connectors
- Screw-on coupling
- High RF performance
- 2 plating options:
 - passivated stainless steel
 - gold plated
- Wide hermetically sealed range
- Space qualified range of products
- SMA extended frequency 27 GHz

APPLICABLE STANDARDS

- MIL-C-39012
- EC 169-1
- CECC 22110
- CECC 22111 - 801 to 808
- BS 9210 N006

**SPACE QUALIFIED/APPROVALS**

(For space range)

- SCC 3402 (ESA)
- CNES

APPLICATIONS

- Civil & Military Telecommunications
- Civil & Military Aeronautics
- Military equipments
- Space
- Measurement systems

PLUG

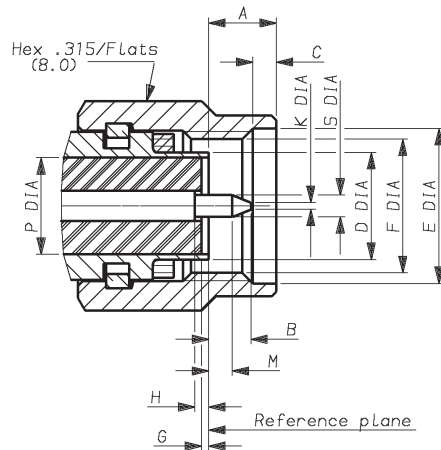

JACK

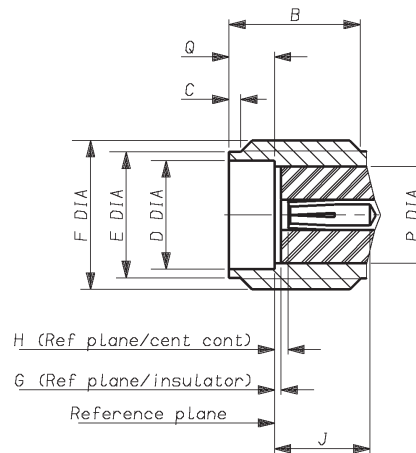

Letter	mm		inch	
	min.	max.	min.	max.
A		3.43		.135
B		2.54		.100
C	0.38	1.14	.015	.045
D DIA		4.59		
E	6.35		.250	
F DIA	1/4 36 UNS 2B			
G*	0.0	-0.20	0.0	-.008
H*	0.0	-0.25	0.0	-.010
J				
K DIA		0.38		.015
M	1.27		.050	
P DIA	4.10 nom.		.161 nom.	
Q DIA				
S DIA	0.90	0.94	.035	.037

Letter	mm		inch	
	min.	max.	min.	max.
A				
B	4.31		.170	
C	0.38	1.14	.015	.045
D DIA	4.596		.181	
E DIA	5.28	5.49	.208	.216
F DIA	1/4 36 UNS 2A			
G*	0.0	-0.20	0.0	-.008
H*	0.0	-0.25	0.0	-.010
J	2.92		.115	
K				
M				
P DIA	4.10 nom.		.161 nom.	
Q	1.88	1.98	.074	.078
S DIA				

*Note: means behind ref plane

CHARACTERISTICS

Test/characteristics		Values/remarks						
ELECTRICAL CHARACTERISTICS								
Impedance		50Ω						
Frequency range		DC - 18 GHz					Extended	
V.S.W.R. (typ.)	Frequency	1 GHz	2.4 GHz	6 GHz	12.4 GHz	18 GHz	27 GHz	
• Straight connector	.085"	1.01	1.01	1.04	1.06	1.06	1.12	
	.141"	1.01	1.01	1.01	1.03	1.05	1.10	
	2.6/50S	1.05	1.07	1.12	1.15			
	5/50S	1.04	1.05	1.10	1.12			
	• Right angle connector	.085"	1.01	1.02	1.06	1.14		
	.141"	1.01	1.02	1.08	1.10			
	2.6/50S	1.06	1.15	1.18	1.24			
	5/50S	1.06	1.15	1.15	1.25			
Insertion loss (typ.) dB								
• Straight connector	.085"	0.03	0.03	0.05	0.08	0.10	0.15	
	.141"	0.02	0.02	0.02	0.02	0.02	0.10	
• Right angle connector	2.6/50S	0.06V/F (F in GHz) max						
	5/50S							
	.085"	0.04	0.04	0.04	0.08			
	.141"	0.04	0.05	0.06	0.09			
	2.6/50S	0.08	0.08	0.10	0.10			
	5/50S	0.04	0.12	0.12	0.25			
RF leakage (dB max)								
• connectors for semi-rigid cables solder attachment		- 90 + F (GHz)						
• connectors for flexible cables crimp attachment		- 60 + F (GHz)						
• receptacles		- 100 + F (GHz)						
Insulation resistance		5 000 MΩ min						
Contact resistance		After tests			Initial			
• outer conductor		4 mΩ			3 mΩ			
• inner conductor		3 mΩ			2 mΩ			
Working voltage in VRMS		.085", RG 405, KS 1	.141", RG 402, KS 2	RG 174, 188, 316, KX 3, KX 22		RG 55, 142, 223, KX 23		
• sea level		350	500	250		335		
• 70 000 ft (21000 m)		85	125	65		85		
Dielectric withstanding voltage in VRMS		1000	1500	750		1000		
RF testing voltage at in VRMS		670	1000	500		670		

MECHANICAL CHARACTERISTICS

Durability	500 matings			
Force to engage and disengage	23 Ncm - (2 inch pounds)			
Recommended coupling nut torque	80 to 115 Ncm - (7 to 10 inch pounds)			
Coupling nut retention force	270 N - (60 Lbs)			
Cable retention force	.085", RG 405, KS 1	.141", RG 402, KS 2	RG 174, 188, 316, KX 3, KX 22	RG 55, 142, 223, KX 23
	135 N (30 Lbs)	270 N (60 Lbs)	110 N (25 Lbs)	180 N (40 Lbs)
Center contact retention force				
• axial	27 N			
• torque	2.8 N			

Test/characteristics	Values/remarks
----------------------	----------------

ENVIRONMENTAL CHARACTERISTICS

Temperature range • standard models • semi-rigid cables • R125 753 000 & R125 603 000	-65°C / + 165°C -65°C / +105°C -40°C / +100°C
Thermal shock	MIL STD 202, method 107, condition B
High temperature test	MIL STD 202, method 108
Corrosion (salt spray)	MIL STD 202, method 101, condition B
Vibration	MIL STD 202, method 204, condition D, 20g
Shock	MIL STD 202, method 213
Moisture resistance	MIL STD 202, method 106
Hermetic test	Down to 10 ⁻⁶ mmHg (Torr) leakage rate < 10 ⁻⁶ atm/cm ³ /sec
Barometric pressure	MIL STD 202, method 105, condition C

MATERIALS AND PLATING

	Material	Plating
Body/nut	Stainless steel	Passivated or gold plated (bodies)
Center contacts	Beryllium copper (female) Brass (male)	Gold plated
Gaskets	Silicone rubber	
Insulators	PTFE	

Standard packaging: 100 pieces.

All dimensions are given in mm

PLUGS

STRAIGHT PLUGS FOR FLEXIBLE CABLES

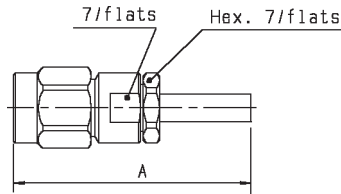
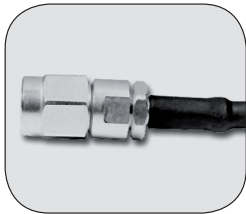

Fig. 1

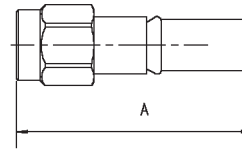

Fig. 2

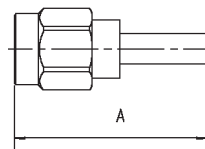

Fig. 3

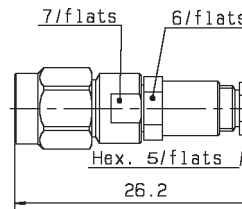

Fig. 4

Cable group	Cable group dia.	Part number (gold)	Part number (passivated)	Fig	Dimensions A (mm)	Captive center contact	Assembly type	Note
RG178/RG196	2/50/S	R125 069 000		1	26	yes	Crimp	
RG174/RG316	2.6/50/S	R125 071 120		3	24.3	yes		Single piece body
		R125 072 000	R125 072 001	2	21.1	no		Single piece body heatshrink sleeve
		R125 073 000	R125 073 001	1	26	yes		
RD316	2.6/50/D	R125 072 080		2	20.1	no		Single piece body heatshrink sleeve
		R125 072 220		3	23.4	yes		Single piece body
RG58/RG141	5/50/S	R125 075 000		3	24.9	no		Single piece body heatshrink sleeve
		R125 077 000		1	28	yes		
RG142/RG223/RG400	5/50/D	R125 076 000	R125 076 001	3	25	no		
		R125 078 000	R125 078 001	1	28	yes		
Special	2.2/50/D		R125 002 200	4	25	yes	Clamp	

To download data sheets and assembly instructions, visit www.radiall.com & enter the part number in the Search box.

Bold part numbers represent products typically in stock & available for immediate shipment.

See page 8 and 9 for packaging information.

PLUGS

STRAIGHT PLUGS SOLDER TYPE FOR SEMI-RIGID CABLES

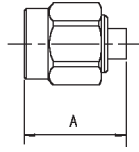
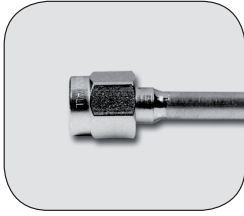

Fig. 1

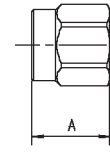

Fig. 2

Cable group	Cable group dia.	Part number (gold)	Part number (gold/passivated coupling nut)	Fig	Dimensions A (mm)	Captive center contact	Note
RG405	.085"	R125 052 000	R125 052 002	1	11.1	no	Single piece body
		R125 052 170					Loose parts
		R125 052 500					Retractable coupling nut/ single piece body
			R125 052 702				DC-27 GHz Single piece body
RG402	.141"	R125 054 000	R125 054 002	2	8.5		Without center contact
		R125 054 500			7.5		Without center contact/ retractable coupling nut
		R125 055 000	R125 055 002	1	11.2	no	Single piece body
		R125 055 500					Retractable coupling nut/ single piece body
			R125 055 702				DC-27 GHz Without center contact
			R125 057 002				Without center contact

STRAIGHT PLUGS CRIMP TYPE FOR SEMI-RIGID CABLES

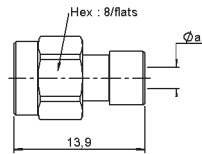
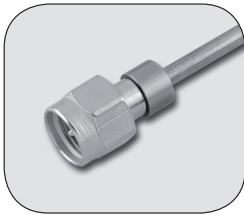

Fig. 1

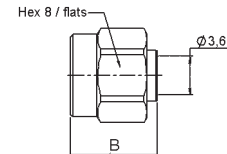

Fig. 2

Cable group	Cable group dia.	Part number (gold)	Part number (gold/passivated coupling nut)	Fig	Dimensions A (mm)	
					∅ a	B
RG405	.085"		R125 052 901	1	2.2	
RG402	.141"		R125 053 901	2		8.25
			R125 054 901	2		9.7
			R125 055 901	1	3.64	

RIGHT ANGLE PLUGS FOR FLEXIBLE CABLES

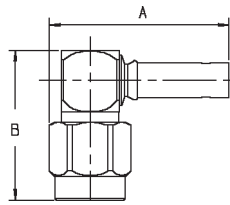

Fig. 1

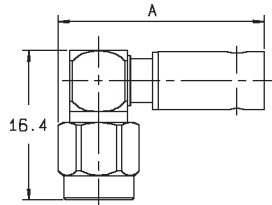

Fig. 2

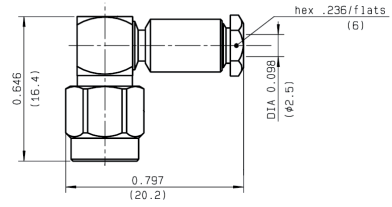

Fig. 3

Cable group	Cable group dia.	Part number (gold)	Part number (passivated)	Fig	Dimensions (mm)		Captive center contact	Assembly type	Note
					A	B			
RG178/RG196	2/50/S	R125 170 402		1	19.6	16.85	yes	crimp	
Special	2.2/50/D		R125 163 200	3	20.2	16.4		clamp	
RG174/RG316	2.6/50/S	R125 172 000	R125 172 001	1	19.6	16.4		crimp	Single piece body
RD316	2.6/50/D	R125 174 000		1	18.6	16.4			Single piece body
RG58/RG141	5/50/S	R125 175 000	R125 175 001	2	21.8				
RG142/RG223/RG400	5/50/D	R125 176 000	R125 176 001	2	21.8				

RIGHT ANGLE PLUGS FOR SEMI-RIGID CABLES

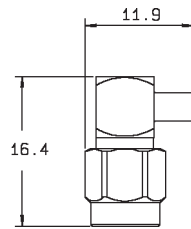
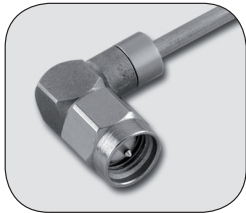
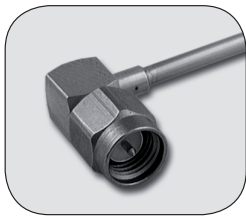

Fig. 1

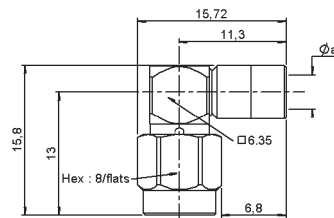

Fig. 2

Cable group	Cable group dia.	Part number (gold)	Part number (gold/passivated nut)	Fig	Dimensions $\varnothing a$ (mm)	Captive center contact	Assembly type
RG405	.085"	R125 153 000	R125 153 002	1		yes	Solder type
RG402	.141"	R125 154 000	R125 154 002	1			Solder type
RG405	.085"		R125 153 901	2	2.2		Crimp type
RG402	.141"		R125 154 901	2	3.62		Crimp type

To download data sheets and assembly instructions, visit www.radiall.com & enter the part number in the Search box. **Bold** part numbers represent products typically in stock & available for immediate shipment. See page 8 and 9 for packaging information.

JACKS

STRAIGHT JACKS CRIMP TYPE FOR FLEXIBLE CABLES

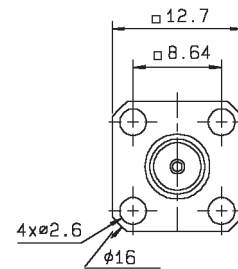
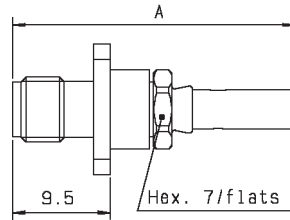
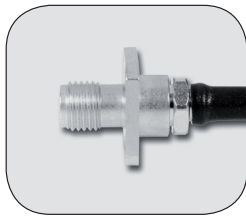

Fig. 1

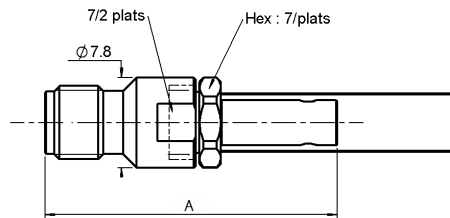

Fig. 2

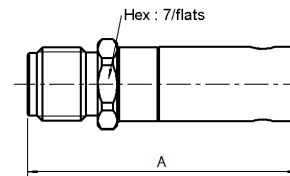

Fig. 3

Cable group	Cable group dia.	Part number (gold)	Fig	Dimensions A (mm)	Captive center contact	Panel drilling	Note
RG174/RG316	2.6/50/S	R125 236 000	2	25.05	yes		Crimp or solder
		R125 272 000	1	27.5		P03	Square flange
RG58/RG141	5/50/S	R125 237 000	3	23.1	no		
RG142/RG223/RG400	5/50/D	R125 238 000					

STRAIGHT JACKS SOLDER TYPE FOR SEMI-RIGID CABLES

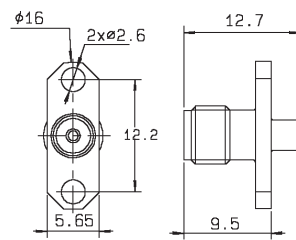

Fig. 1

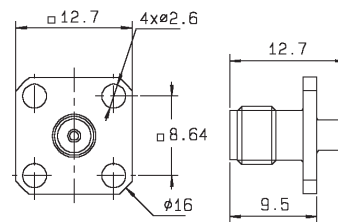

Fig. 2

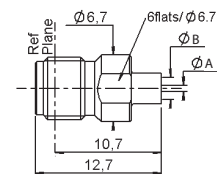

Fig. 3

Cable group	Cable group dia.	Part number (gold)	Fig	Dimensions		Captive center contact	Panel drilling	Note
				A (mm)	B (mm)			
RG405	.085"	R125 222 000	3	0.65	2.25	no		
		R125 252 000	1				P02	2 hole flange
		R125 256 000	2				P03	square flange
RG402	.141"	R125 225 000	3	0.95	3.65			
		R125 251 000	1				P02	2 hole flange
		R125 255 000	2				P03	square flange

BULKHEAD JACKS CRIMP TYPE FOR FLEXIBLE CABLES (rear mount)

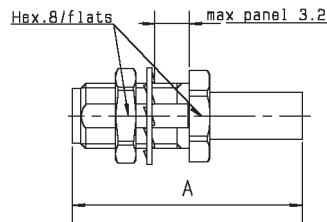

Fig. 1

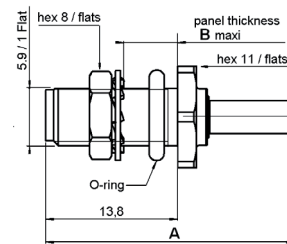

Fig. 2

Cable group	Cable group dia.	Part number (gold)	Part number (passivated)	Fig	Dimensions (mm)		Captive center contact	Panel drilling	Note		
					A	B					
RG178/RG196	2/50/S	R125 320 020		2	26.1	5.6	yes	P06	Totally waterproof		
RG174/RG316	2.6/50/S	R125 303 000	R125 303 001	1	25.7				Crimp and solder		
		R125 312 120				Full crimp					
RD316	2.6/50/D	R125 313 120		2	22.4				Full crimp		
		R125 322 030				Panel sealed					
RG58/RG141	5/50/S	R125 314 120		1	25.4				Full crimp		
RG142/RG223/RG400	5/50/D	R125 315 120				1			29.6		Crimp and solder
		R125 308 000									

BULKHEAD JACKS SOLDER TYPE FOR SEMI-RIGID CABLES (rear mount)

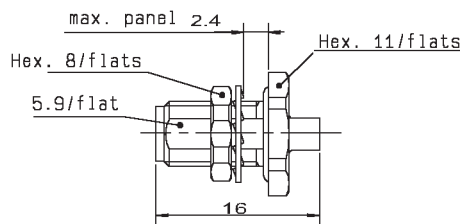
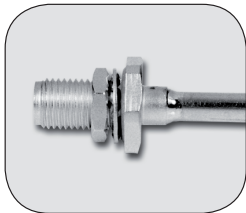

Fig. 1

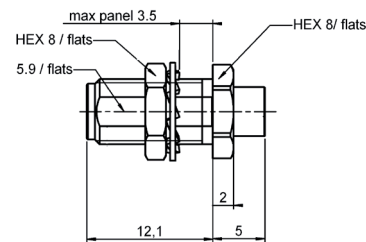

Fig. 2

Cable group	Cable group dia.	Part number (gold)	Fig	Captive center contact	Panel drilling	Note
RG405	.085"	R125 326 000	1	no	P06	Panel sealed
RG402	.141"	R125 325 000				
		R125 305 000	2			

To download data sheets and assembly instructions, visit www.radiall.com & enter the part number in the Search box. **Bold** part numbers represent products typically in stock & available for immediate shipment. See page 8 and 9 for packaging information.

RECEPTACLES

STRAIGHT FEMALE FLANGE RECEPTACLES - SOLDER POT

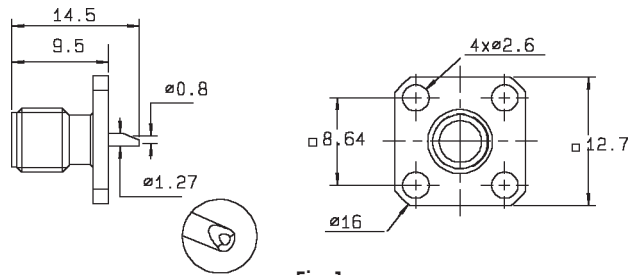
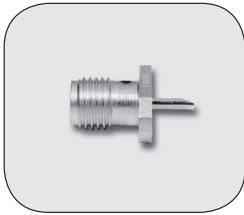

Fig. 1

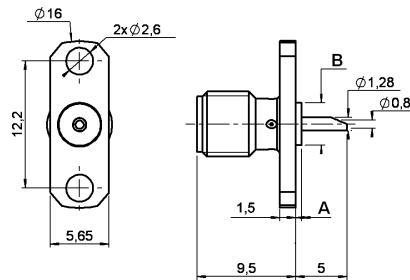
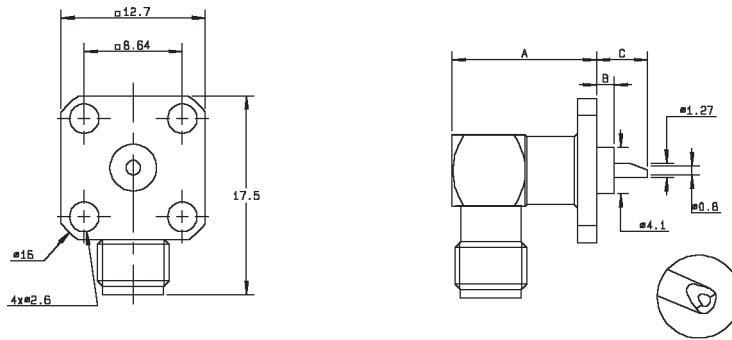

Fig. 2

Part number (gold)	Part number (passivated)	Fig	Dimensions (mm)		Captive center contact	Panel drilling	Note
			A	B			
R125 403 000	R125 403 001	1			yes	P04	square flange
R125 453 000		2	0.6	∅ 4.06		P01	2 hole flange
R125 454 000	R125 454 001						

RIGHT ANGLE FEMALE SQUARE FLANGE RECEPTACLES - SOLDER POT



Part number (gold)	Part number (passivated)	Dimensions (mm)			Captive center contact	Panel drilling
		A	B	C		
	R125 653 001	12.4	1.57	4.6	yes	P04
R125 654 000		11.1	0	6.1		

BULKHEAD FEMALE RECEPTACLE (rear mount)

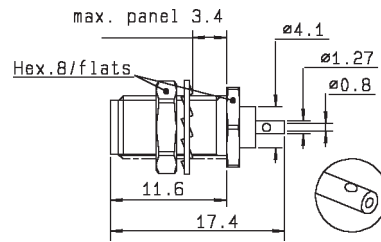

Part number (gold)	Part number (passivated)	Captive center contact	Panel drilling
R125 553 000	R125 553 001	yes	P06

SCREW-ON FEMALE RECEPTACLES (front mount)

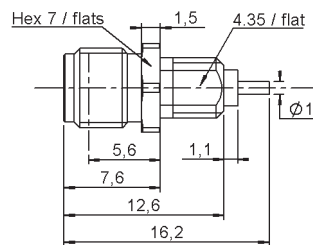
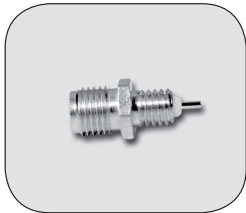

Fig. 1

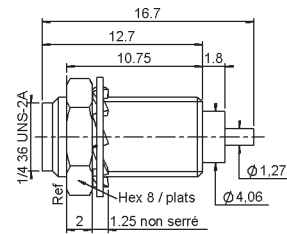

Fig. 2

Part number (gold)	Fig	Captive center contact	Note
R125 555 500	1	yes	screw-on
R125 560 000	2		

STRAIGHT MALE FLANGE RECEPTACLES - SOLDER POT

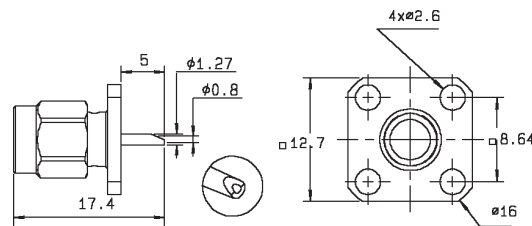
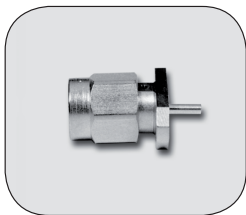

Fig. 1

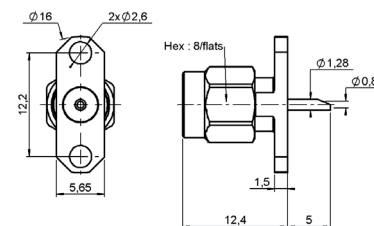

Fig. 2

Part number (gold)	Fig	Captive center contact	Panel drilling	Note
R125 433 000	1	yes	P04	Square flange
R125 483 000	2		P01	2 hole flange

To download data sheets and assembly instructions, visit www.radiall.com & enter the part number in the Search box. **Bold** part numbers represent products typically in stock & available for immediate shipment. See page 8 and 9 for packaging information.

RECEPTACLES

SQUARE FLANGE EXTENDED DIELECTRIC FEMALE RECEPTACLES

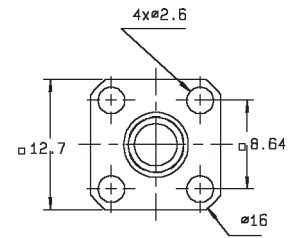
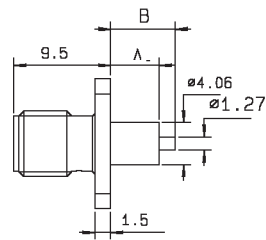
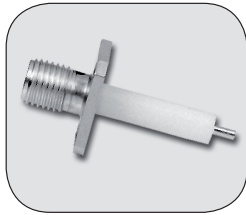

Part number (gold)	Part number (passivated)	Dimensions (mm)		Captive center contact	Panel drilling	Note
		A	B			
R125 413 000	R125 413 001	12.7	15.9	no	P04	no captivation
R125 414 000	R125 414 001			epoxy		
R125 414 004				4 indents		
R125 415 000	R125 415 001	18	20.5	yes		epoxy
R125 415 270	R125 415 271	15	17.9			

2 HOLE FLANGE EXTENDED DIELECTRIC FEMALE RECEPTACLES

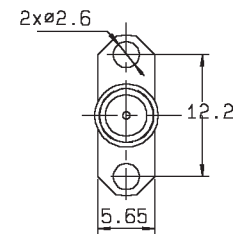
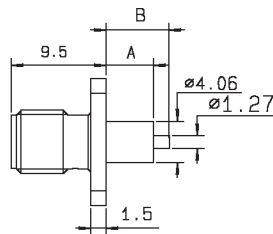
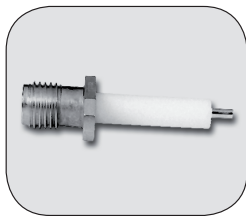

Part number (gold)	Part number (passivated)	Dimensions (mm)		Captive center contact	Panel drilling	Note
		A	B			
R125 464 000	R125 464 001	12.7	15.9	yes	P01	epoxy
R125 464 270	R125 464 271	15	17.9			4 indents
R125 464 274						

RIGHT ANGLE FEMALE SQUARE FLANGE EXTENDED DIELECTRIC RECEPTACLES

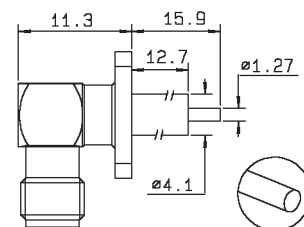
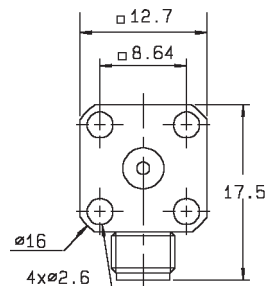
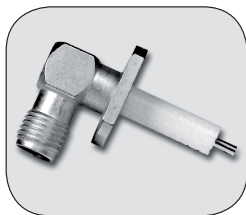

Part number (gold)	Part number (passivated)	Captive center contact	Panel drilling
R125 654 450	R125 654 451	yes	P04

STRAIGHT MALE FLANGE EXTENDED DIELECTRIC RECEPTACLES

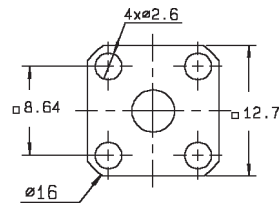
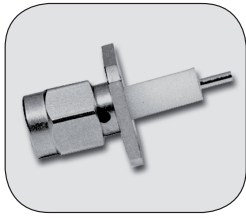

Fig. 1

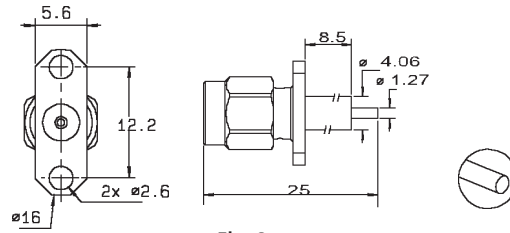

Fig. 2

Part number (gold)	Part number (passivated)	Fig	Captive center contact	Panel drilling	Note
R125 444 000	R125 444 001	1	yes	P04	Square flange
R125 474 000	R125 474 001	2		P01	2 hole flange

PCB FEMALE RECEPTACLES

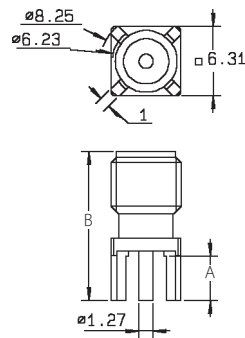

Fig. 1

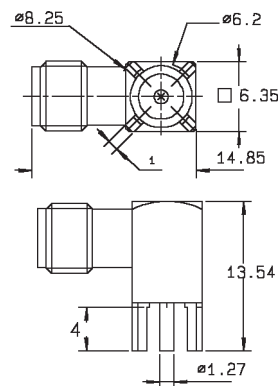

Fig. 2

Part number (gold)	Fig	Dimensions (mm)		Captive center contact	PCB pattern	Note
		A	B			
R125 426 000	1	4	13.5	yes	P05	Selective tin plating
R125 426 140		6.9	14.4			

To download data sheets and assembly instructions, visit www.radiall.com & enter the part number in the Search box.
Bold part numbers represent products typically in stock & available for immediate shipment.
 See page 8 and 9 for packaging information.

RECEPTACLES FOR MICROSTRIP

STRAIGHT FEMALE SQUARE FLANGE RECEPTACLES - TAB CONTACT

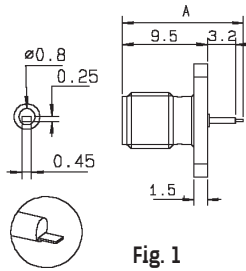
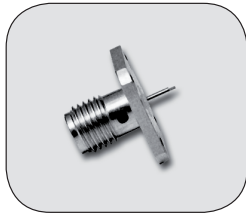

Fig. 1

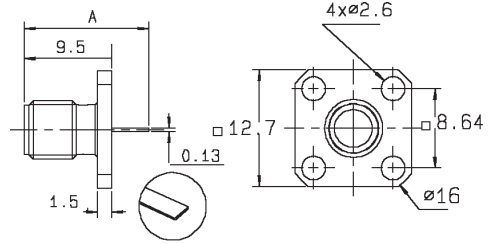

Fig. 2

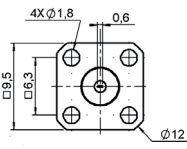

Fig. 3

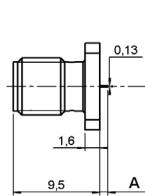

Fig. 4

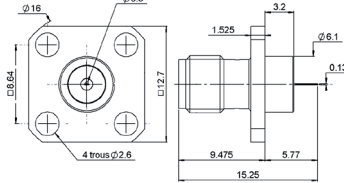
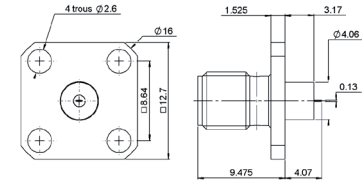

Fig. 5



Part number (gold)	Part number (passivated)	Fig	Dimensions A (mm)	Captive center contact	Panel drilling	Contact type
R125 501 000	R125 501 001	1	13.5	yes	P04	offset tab
R125 510 000	R125 510 001	2	12		P11	tab
R125 510 500	R125 510 501	3	2.5			
R125 612 120		4				
R125 620 000	R125 620 001	2	10.38			
R125 622 000	R125 622 001	5				
	R125 943 001	3	0.89			

STRAIGHT FEMALE 2 HOLE FLANGE RECEPTACLES - TAB CONTACT

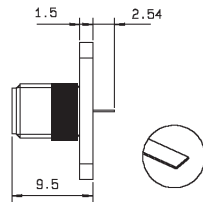
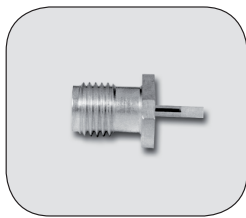

Fig. 1

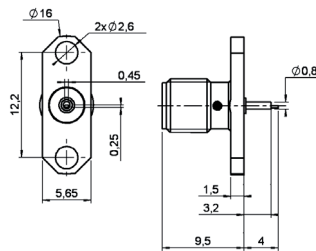
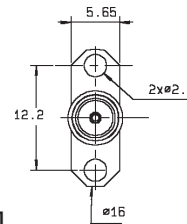

Fig. 2

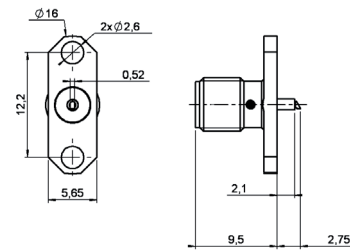
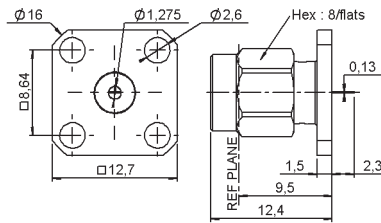
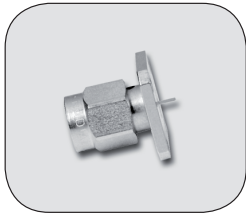

Fig. 3

Part number (gold)	Fig	Captive center contact	Panel drilling	Contact type
R125 451 000	2	yes	P01	offset tab
R125 452 000	3			special
R125 497 000	1			tab

STRAIGHT MALE SQUARE FLANGE RECEPTACLES - TAB CONTACT



Part number (gold)	Part number (passivated)	Captive center contact	Panel drilling	Note
R125 488 000	R125 488 001	yes	P04	Unit packaging

STRAIGHT FEMALE SQUARE FLANGE RECEPTACLES - CYLINDRICAL CONTACT

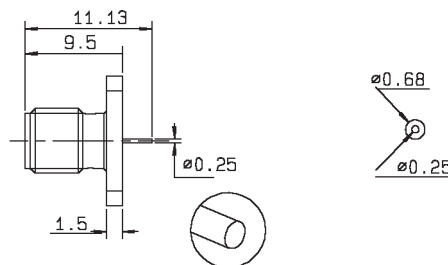

Part number (gold)	Captive center contact	Panel drilling	Note
R125 610 000	yes	P04	Unit packaging

STRAIGHT FEMALE FLANGE RECEPTACLES - CYLINDRICAL CONTACT

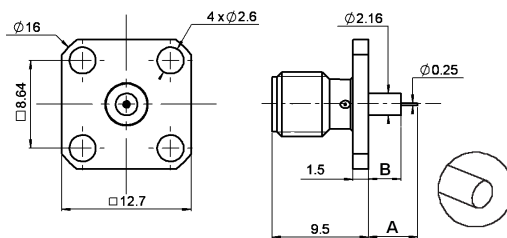
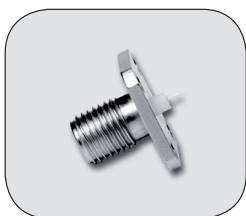

Fig. 1

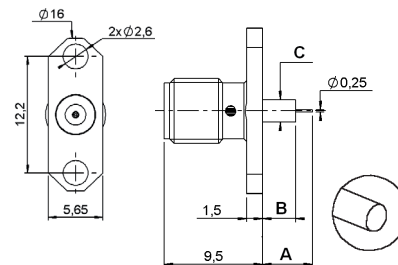

Fig. 2

Part number (gold)	Part number (passivated)	Fig	Dimensions (mm)			Captive center contact	Panel drilling	Note
			A	B	C			
R125 512 000	R125 512 001	1	4.8	3.2		yes	P04	Square flange
R125 513 000			3.2	1.6				
R125 462 000	R125 462 001	2	4.8	3.2	2.16		P01	2 hole flange
R125 463 000			3.2	1.6	2.16			
	R125 617 001		4.8	3.2	4.06			

To download data sheets and assembly instructions, visit www.radiall.com & enter the part number in the Search box. **Bold** part numbers represent products typically in stock & available for immediate shipment. See page 8 and 9 for packaging information.

RECEPTACLES FOR MICROSTRIP

STRAIGHT MALE FLANGE RECEPTACLES - CYLINDRICAL CONTACT

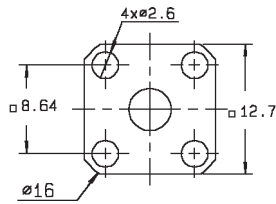
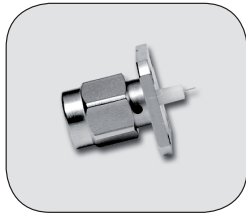

Fig. 1

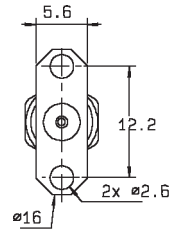
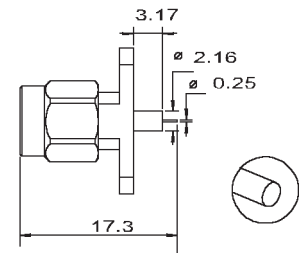

Fig. 2



Part number (gold)	Part number (passivated)	Fig	Captive center contact	Panel drilling	Note
R125 492 000	R125 492 001	1	yes	P04	Square flange
R125 484 000	R125 484 001	2		P01	2 hole flange

UNIVERSAL FIELD-REPLACEABLE RECEPTACLES - FEMALE SOCKET

(accept pin \varnothing 0.93 mm [.037"])

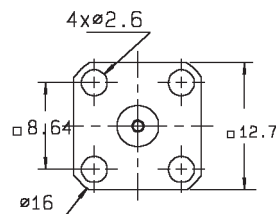

Fig. 1

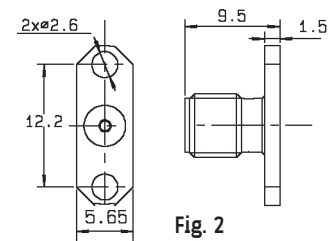
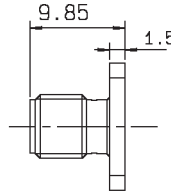

Fig. 2

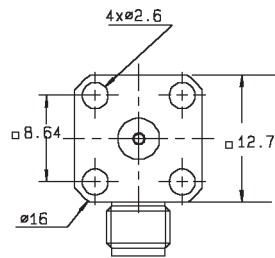

Fig. 3

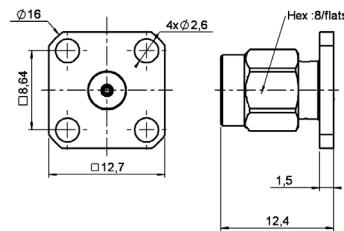
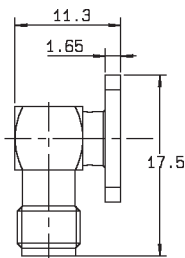

Fig. 4

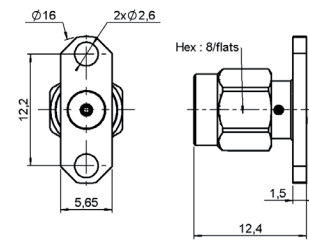
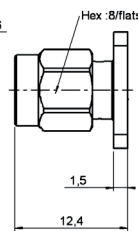

Fig. 5

Part number (gold)	Part number (passivated)	Fig	Captive center contact	Panel drilling	Note
R125 410 000	R125 410 001	1	yes	P04	Female-square flange
	R125 430 001	4			Male-square flange
R125 460 000	R125 460 001	2		P01	Female-2 hole flange - Unit packaging
	R125 480 001	5			Male-2 hole flange
	R125 670 001	3			P04

RECEPTACLES FOR MICROSTRIP

SMA

EDGE CARD RECEPTACLES

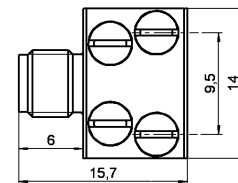
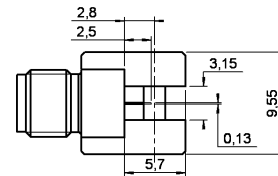
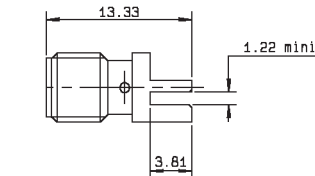
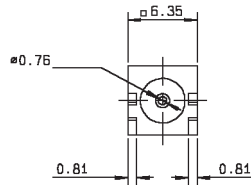
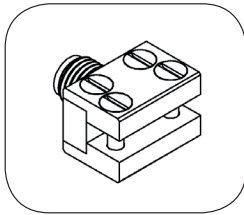

Fig. 1

Fig. 2

Part number (gold)	Fig	Captive center contact	Note
R125 423 200	1	yes	Solder pins
R125 541 000	2		4 screws

HERMETIC RECEPTACLES WITH SEPARATE GLASS BEAD

SQUARE FLANGE 12.7 mm FEMALE RECEPTACLE

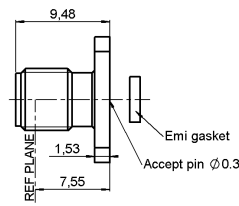
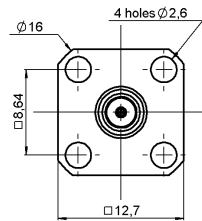
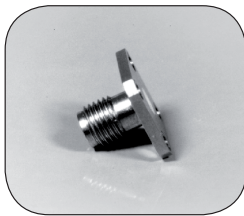

Part number (gold)	Part number (passivated)	Glass bead only	EMI gasket only	Panel drilling connector	Panel drilling glass bead
R125 411 000	R125 411 001	R280 751 000	R280 510 000	P10	P13

NARROW FLANGE FEMALE RECEPTACLES

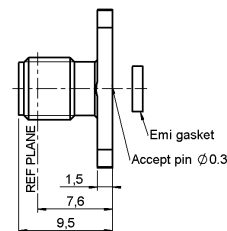
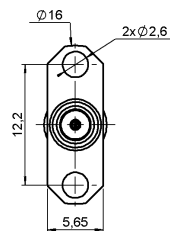
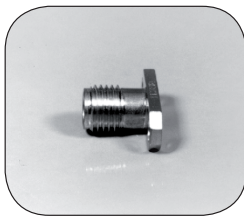

Part number (passivated)	Glass bead only	EMI gasket only	Panel drilling connector	Panel drilling glass bead
R125 465 001	R280 751 000	R280 510 000	P12	P13
R125 465 011	R280 757 070			P18

To download data sheets and assembly instructions, visit www.radiall.com & enter the part number in the Search box. **Bold** part numbers represent products typically in stock & available for immediate shipment. See page 8 and 9 for packaging information.

HERMETIC RECEPTACLES WITH SEPARATE GLASS BEAD

NARROW FLANGE MALE RECEPTACLES

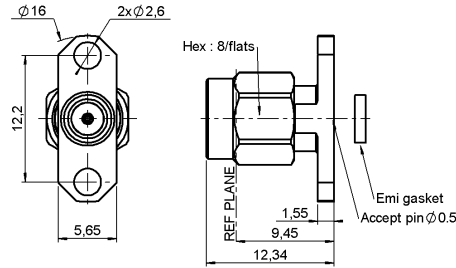
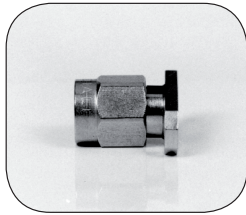

Part number (passivated)	Glass bead only	EMI gasket only	Panel drilling connector	Panel drilling glass bead
R125 481 001	R280 751 000	R280 510 000	P12	P13
R125 481 011	R280 757 070			P18

SCREW-ON TYPE FEMALE RECEPTACLES

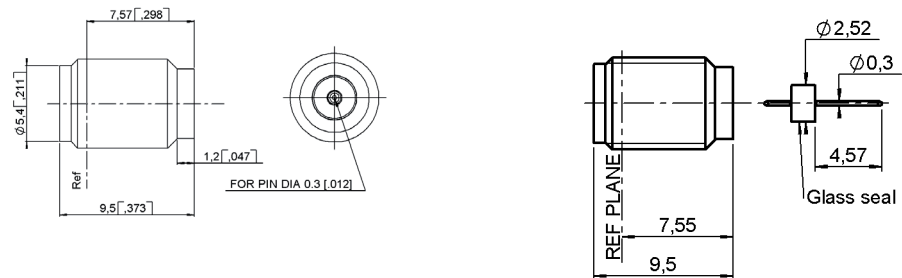
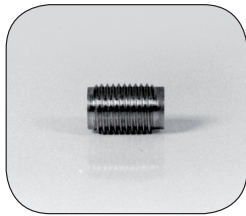

Part number (passivated)	Glass bead only	Fig	Assembly tool	Packaging	Panel drilling glass bead	Note
R125 556 001	R280 751 000	1	R282 341 010	1	P15	-
R125 556 011	R280 757 070				P19	-
R125 638 001	R280 751 350	2			P15	Supplied with glass bead

HERMETIC RECEPTACLES WITH INTEGRATED GLASS BEAD

Panel feedthrough receptacles feature an internal hermetic glass bead. A ring of solder between the receptacle body and the package will provide the hermeticity level.

SOLDER TYPE FEMALE RECEPTACLE

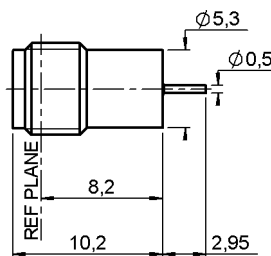
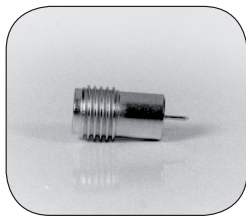

Part number (gold)	Captive center contact	Connector body	Contact type	Packaging
R125 630 000	yes	FN42 alloy	cylindrical	1
R125 630 040		Stainless steel		

HERMETIC RECEPTACLES WITH INTEGRATED GLASS BEAD

Screw-on receptacles with integrated glass seal, the compression gasket will ensure the hermeticity between the receptacle and the package.

SCREW-ON TYPE, FEMALE RECEPTACLE

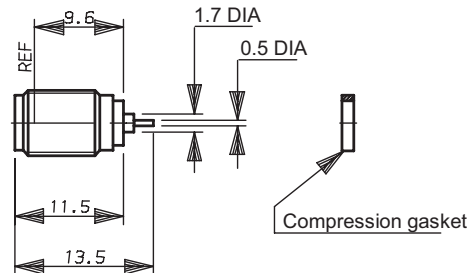
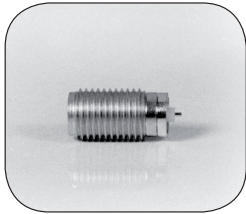

Part number (passivated) R125 609 001	Panel drilling P05
------------------------------------------	-----------------------

SCREW-ON TYPE, FEMALE RECEPTACLE WITH SLIDING CONTACT

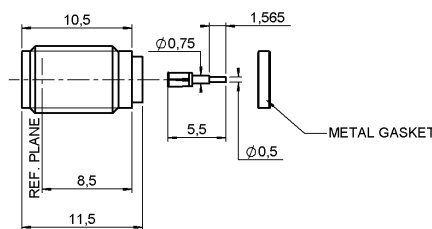
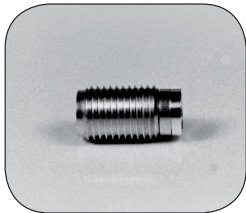

Fig. 1

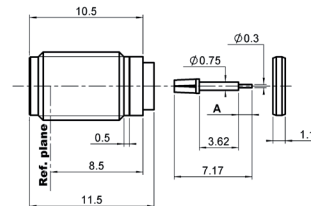

Fig. 2

Part number (gold)	Part number (passivated)	Dimension A (mm)	Panel drilling	Contact type
-	R125 609 031	-	P05	cylindrical
R125 609 160	-	1.24		
R125 609 170	-	0.75		

HERMETIC RECEPTACLES WITHOUT GLASS BEAD

Screw-on receptacles without glass bead provide a lower hermeticity level (10^{-6} atm/cm³/sec). A gasket will guarantee the hermeticity between the receptacle and the package.

SCREW-ON TYPE, FEMALE RECEPTACLE WITH SLIDING CONTACT

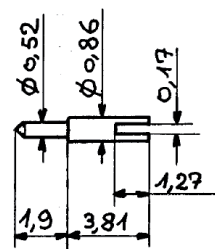
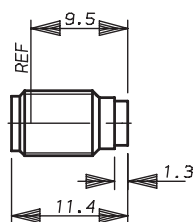
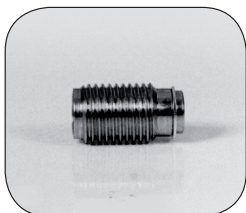

Part number (passivated) R125 605 301	Panel drilling P08	Contact type slotted
------------------------------------------	-----------------------	-------------------------

To download data sheets and assembly instructions, visit www.radiall.com & enter the part number in the Search box. **Bold** part numbers represent products typically in stock & available for immediate shipment. See page 8 and 9 for packaging information.

ADAPTERS

IN SERIES ADAPTERS

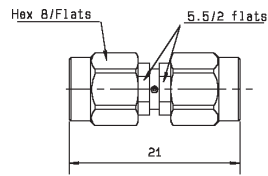

Fig. 1

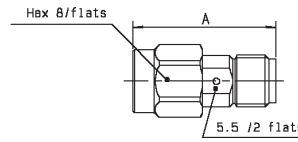

Fig. 2

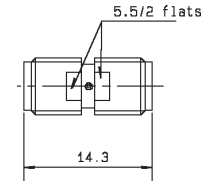

Fig. 3

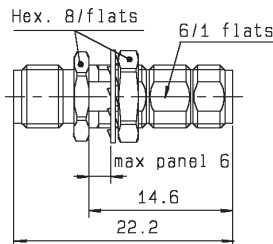

Fig. 4

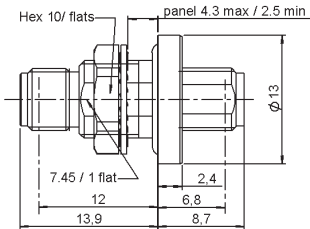

Fig. 5

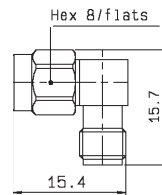

Fig. 6

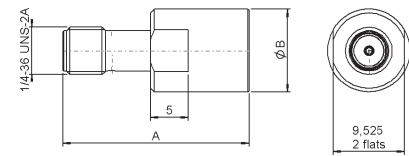
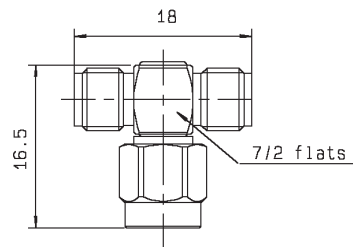

Fig. 7

Part number (gold)	Part number (passivated)	Fig	Dimensions (mm)		Captive center contact	Panel drilling	Note	
			A	B				
R125 703 000	R125 703 001	1			yes		Male-male	
R125 704 000	R125 704 001	2	17.5				Male-female	
R125 705 000	R125 705 001	3					Female-female	
R125 720 000	R125 720 001	4				P06	Bulkhead female-female	
R125 753 000	R125 753 001	5				P08	Bulkhead hermetically sealed female-female	
R125 771 000	R125 771 001	6					Right angle male-female	
	R125 791 501	7	23.3	8.9				PUSH-ON male
	R125 792 501		24.8	11				PUSH-ON female

TEE IN SERIES ADAPTERS



Part number (gold)	Part number (passivated)	Captive center contact
R125 780 000	R125 780 001	yes

MALE AND FEMALE CAPS

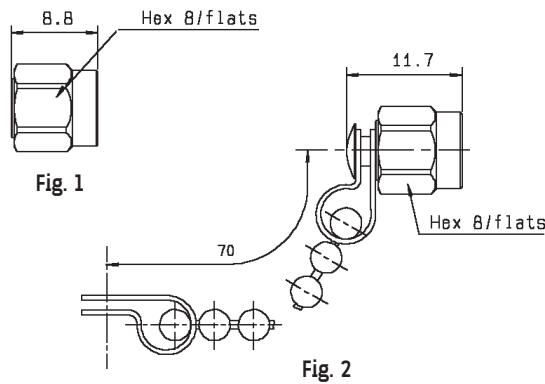
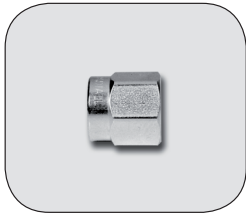

Part number (gold)	Part number (passivated)	Fig	Note
R125 802 000	R125 802 001	1	Male
R125 812 000	R125 812 001	2	Male
	R125 852 001	1	Male short circuit

CENTER CONTACTS (To be used with universal receptacle)

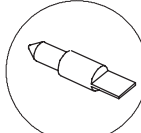
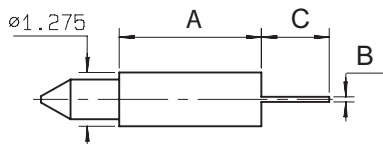
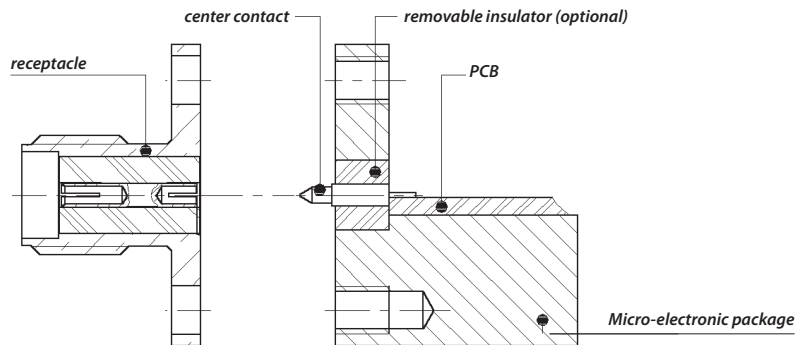

Fig. 1

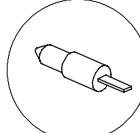

Fig. 2

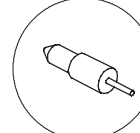

Fig. 3

Part number	Fig.	Termination	Dimensions (mm)			Packaging
			A	B	C	
R280 461 000	1	Tab	3.37	0.13	1.6	10 pieces
R280 461 200	2	Tab special	3.37	0.13 x W0.51	1.6	
R280 461 210	1	Tab	10.3	0.13	1.6	
R280 463 000	3	Cylindrical	3.37	dia 0.25	1.6	
R280 465 000	2	Tab special	0.2	0.13 x W0.60	0.9	

To download data sheets and assembly instructions, visit www.radiall.com & enter the part number in the Search box. **Bold** part numbers represent products typically in stock & available for immediate shipment. See page 8 and 9 for packaging information.

GLASS BEADS

GLASS BEADS FOR HERMETIC RECEPTACLES

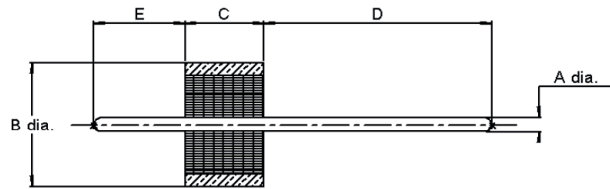
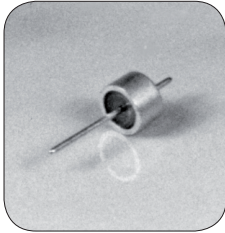

Hermeticity guaranteed at 10^{-8} atm.cm³/s

Part number	Dimensions mm (inch)				
	A	B	C	D	E
R280 751 000	0.30 (.012)	2.52 (.099)	1.60 (.063)	4.57 (.180)	1.83 (.072)
R280 751 080				1.3 (.051)	
R280 755 000	0.46 (.018)	2.85 (.112)	1.60 (.063)		
R280 757 070	0.50 (.019)	4 (.157)	1.77 (.070)	1.77 (.070)	2.03 (.080)
R280 757 080				5.82 (.230)	1.93 (.076)
R280 760 040	0.30 (.012)	1.93 (.076)	1.40 (.055)	0.74 (.029)	1.04 (.041)
R280 751 350	0.30 (.012)	2.52 (.099)	1.60 (.063)	4.57 (.180)	1.83 (.072)
R280 752 000	0.38 (.015)	2.50 (.098)	1.56 (.061)	1.95 (.076)	1.59 (.062)
R280 752 020	0.38 (.015)	2.50 (.098)	1.56 (.061)	1.3 (.051)	1.59 (.062)
R280 755 040	0.46 (.018)	2.85 (.111)	1.60 (.063)	4.57 (.180)	1.83 (.072)

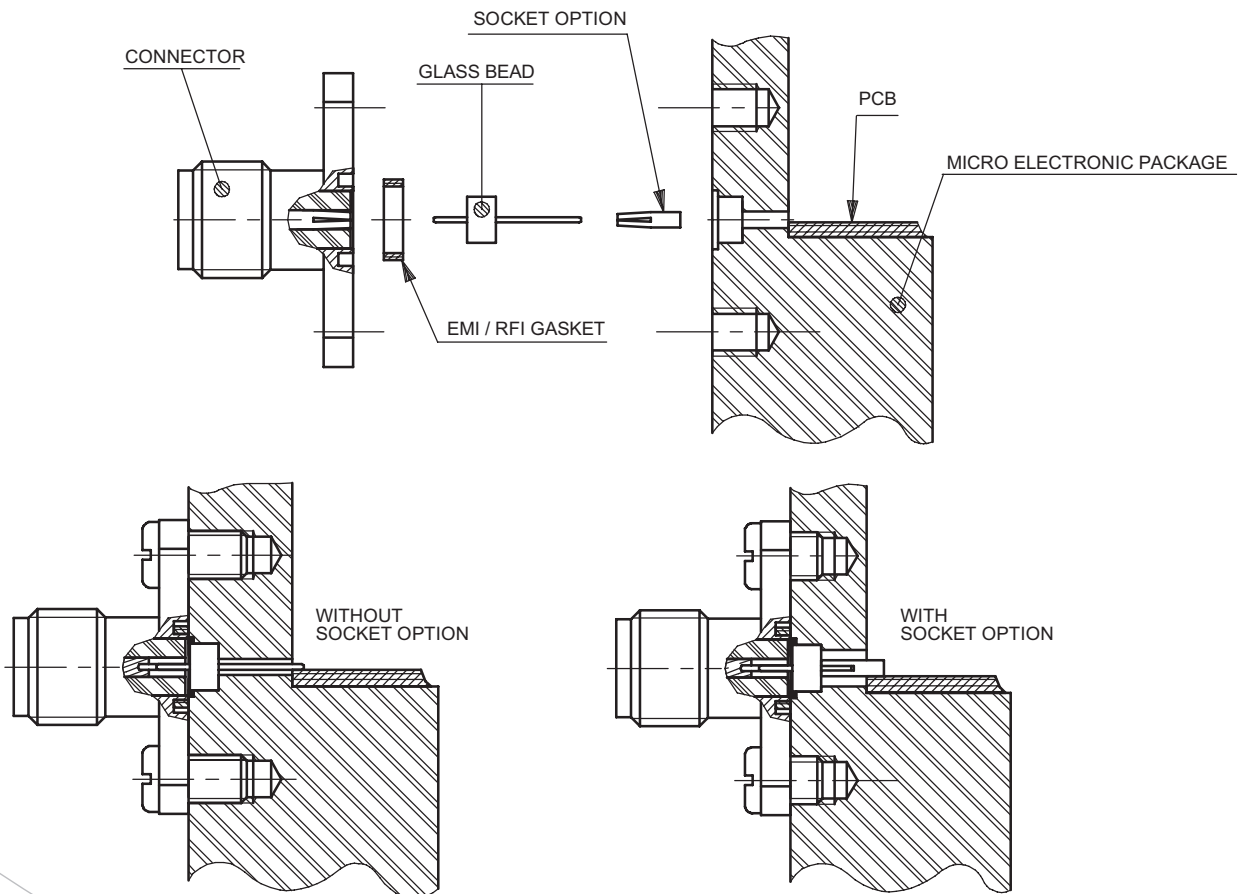

ACCESSORIES FOR HERMETIC MICROSTRIP RECEPTACLES

SMA

OPTIONAL SOCKET

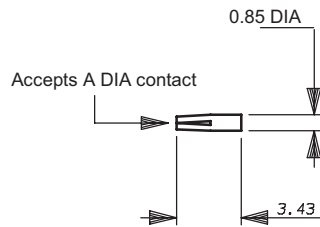
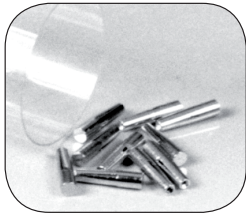

Part number	A Dia (mm)	Packaging
R280 469 000	0.30	10 pieces
R280 469 010	0.46	

For use with glass seal.

PANEL DRILLING

P01

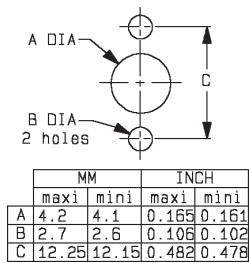

P02

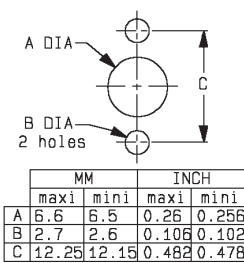

P03

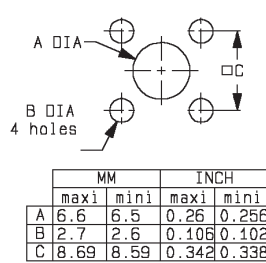

P04

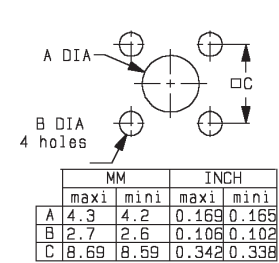

P05

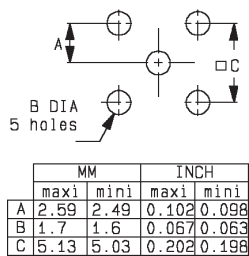

P06

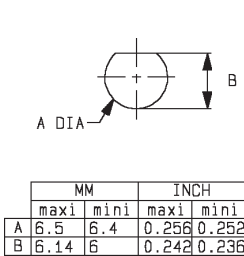

P08

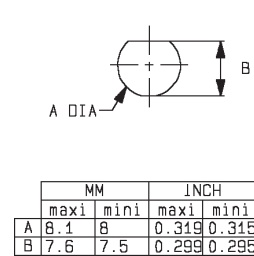

P09

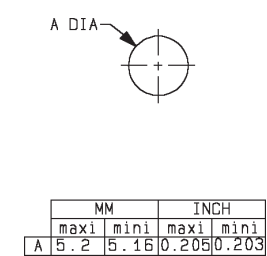

P10

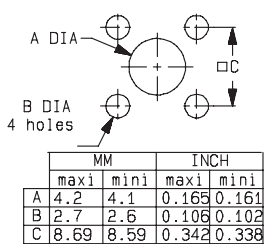

P11

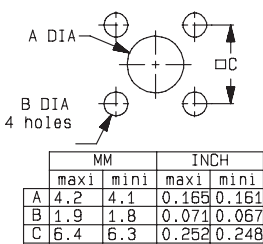

P12

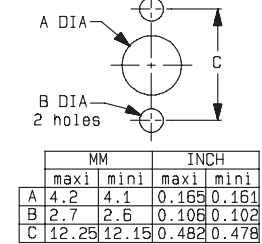

To download data sheets and assembly instructions, visit www.radiall.com & enter the part number in the Search box.
Bold part numbers represent products typically in stock & available for immediate shipment.
 See page 8 and 9 for packaging information.

PANEL DRILLING

HERMETIC SEPARATE GLASS BEAD RECEPTACLES

P13/14

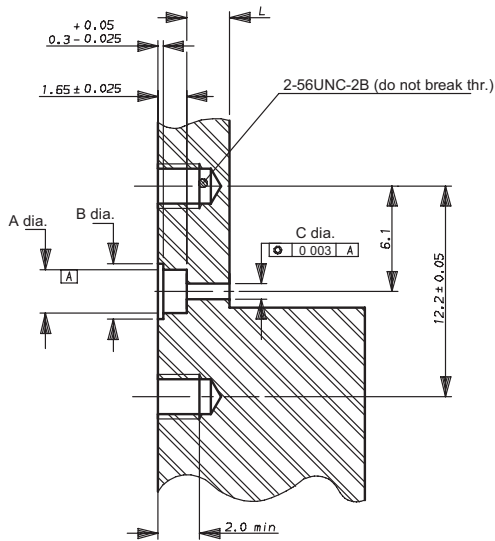

	P13	P14
A dia.	2.6±0.025	2.92±0.025
B dia.	3.23±0.025	3.55±0.025
C dia.	2±0.02	
	0.7±0.02	1.08±0.02
L dia.	2.5±0.1	
	from 1 mm to 4 mm	

- (1) Using of the removable contact.
- (2) The pin is directly welded on the trace.

P15/16

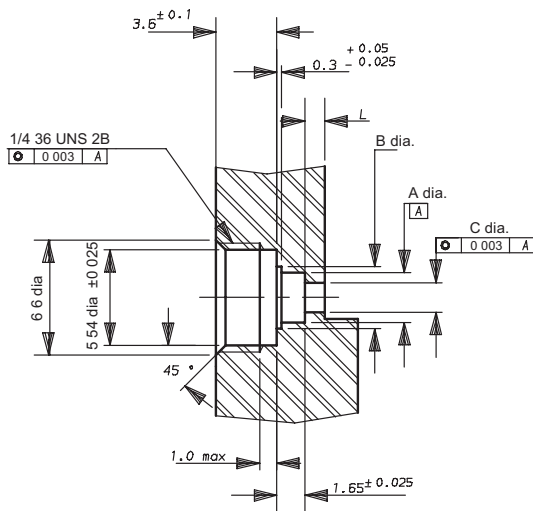

	P15	P16
A dia.	2.6±0.025	2.92±0.025
B dia.	3.23±0.025	3.55±0.025
C dia.	2±0.02	
	0.7±0.02	1.08±0.02
L dia.	2.5±0.1	
	from 1 mm to 4 mm	

- (1) Using of the removable contact.
- (2) The pin is directly welded on the trace.

P17

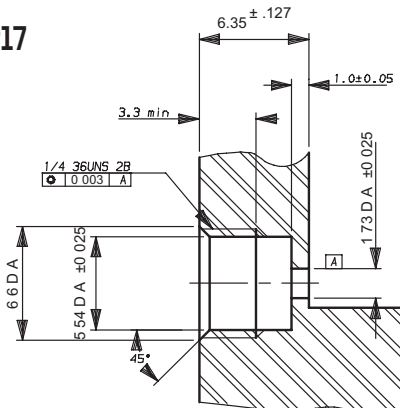

P18

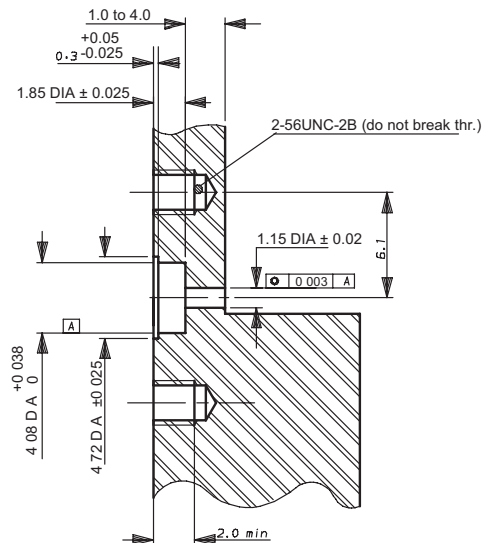

HERMETIC SEPARATE GLASS BEAD RECEPTACLES

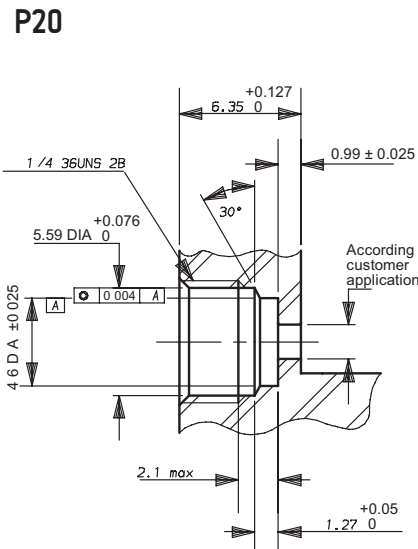
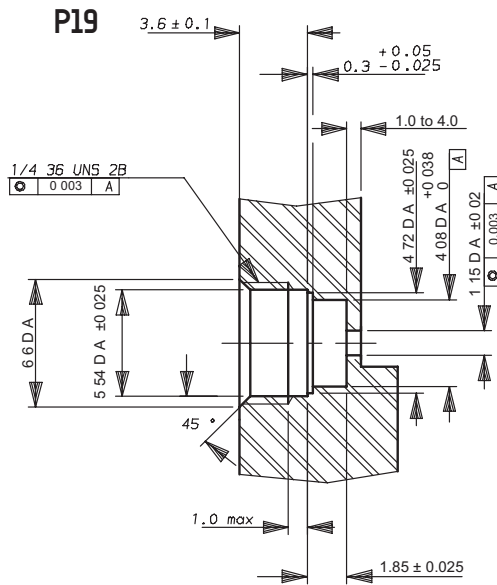

TOOLING FOR HERMETIC RECEPTACLES

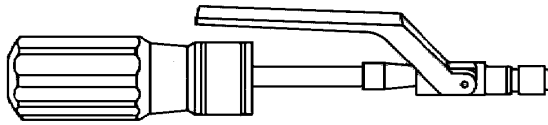

Coupling torque: **190 cm N**

Part number	Description
R282 341 010	Installation tool for jack receptacles
	R125 556 000
	R125 556 001
	R125 556 010
	R125 556 011

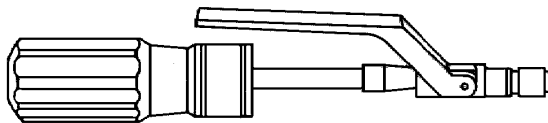

Coupling torque: **280 cm N**

Part number	Description
R282 341 012	Installation tool for jack receptacles
	R125 605 361
	R125 605 371
	R125 605 401
	R125 609 000
	R125 609 001
	R125 609 010
	R125 609 011
	R125 609 070
	R125 609 071

To download data sheets and assembly instructions, visit www.radiall.com & enter the part number in the Search box.
Bold part numbers represent products typically in stock & available for immediate shipment.
 See page 8 and 9 for packaging information.

FIELD REPLACEABLE HERMETIC MICROSTRIP RECEPTACLE INFORMATION

ELECTRICAL PERFORMANCES:

V.S.W.R. to 18 GHz

connector only	seal only	connector & seal
1.04 + 0.006F (GHz)	1.02 + 0.003F (GHz)	1.06 + 0.01F (GHz)

V.S.W.R. MEASUREMENT

Setting for V.S.W.R. measurement on field replaceable hermetic receptacle

a) Measurement with auxiliary contact-assembly drawing

R280 469 000 (for pin DIA 0.30 mm)
R280 469 010 (for pin DIA 0.46 mm)

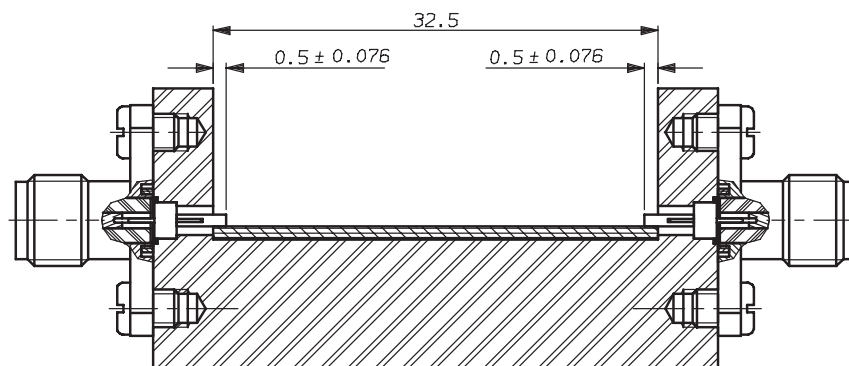

b) Measurement without auxiliary contact-assembly drawing

Recommended value : L1 = 1.0 mm

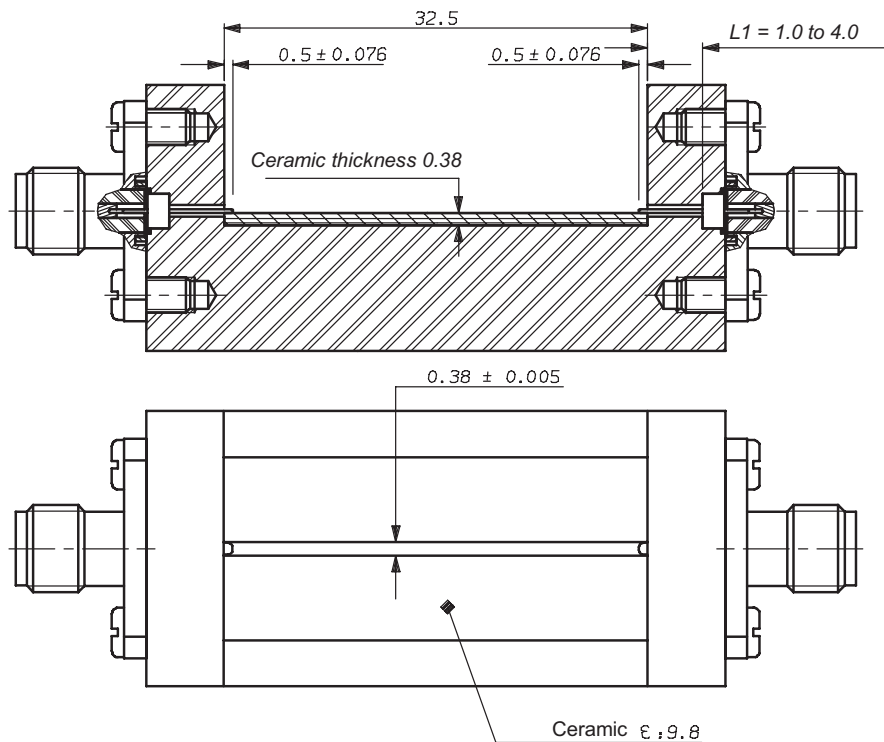

The track width on ceramic defines the circuit impedance.

www.radiall.com

FIELD REPLACEABLE HERMETIC MICROSTRIP RECEPTACLE INFORMATION

SMA

GLASS BEAD AND CONNECTOR ASSEMBLY INTO THE MICRO ELECTRONIC PACKAGE

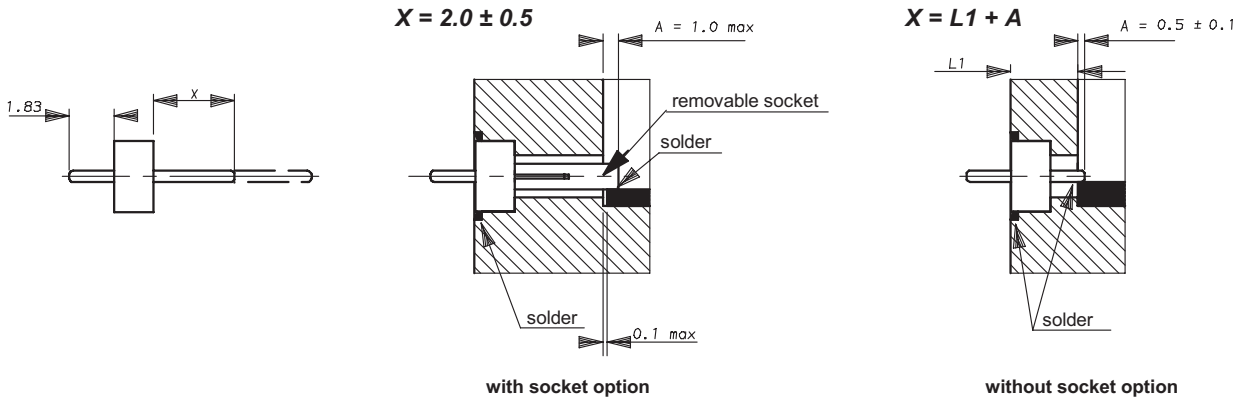

GLASS BEAD

- 1 Adjust X by cutting the pin if necessary.
- 2 Introduce the glass bead into its cavity.
- 3 Place a ring of solder in the groove around the glass bead (a 0.3 mm wire dia. of solder is recommended).
- 4 Solder the pin (or optional socket) on the PCB trace inside the package.

Beware there is not too much welding.

IMPORTANT: For maximum RF performances, the link track/pin must be as thin as possible.

We advise therefore to follow the A dimension rigorously, by soldering accurately the pin or the socket directly on the trace.

CONNECTOR RECEPTACLE

Place the "EMI" screening gasket in the groove of the receptacle (if applicable).

Introduce gently the receptacle on the glass bead pin, then screw the flange (use the appropriated tool for screw-in receptacle).

GLASS BEAD MOUNTING

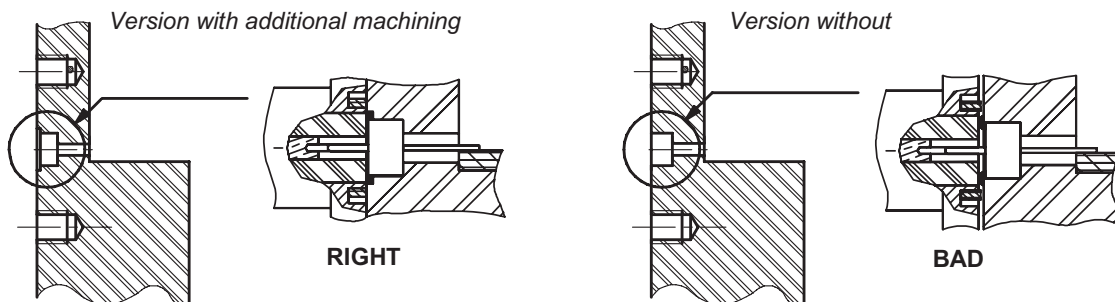

The RADIAL panel drilling on page 8-27 recommends an additional bore or chamfer machining on the outer edge of the glass bead housing. This additional machining allows to place a pre-form (solder stick Dia. 0.3 mm) before soldering. After mounting, solder is flushing and allows the right positioning of the receptacle.

The EMI gasket efficiency is guaranteed.

INTRODUCTION

Radiall Commercial SMA connectors are specially designed for applications where low installed costs are of the utmost importance. They are easy, fast to assemble and reliable, and offer the perfect solution for high volume applications requiring high level performance such as in civil telecommunications, datacommunications or test and measurement.

- **Full compatibility:**

These Commercial SMA connectors are fully compatible (interchangeable and intermateable) with all existing MIL standardized SMA connectors. They feature the same performance level except for mechanical characteristics (life: 100 matings and coupling nut torque: 60 Ncm). The coupling nut of the Commercial SMA connectors features a special design which is different from the standard SMA coupling nut as the tightening torque is reduced.

- **Wide range:**

The Commercial SMA series offers a wide range of solutions which are for every standard coaxial flexible or semi-rigid cable as well as PCB models with traditional through-hole pins or solder pads for SMT applications.

- **Simple snap-in axial captivation (for full crimp models):**

The relative position of the center contact into the interface is mechanically guaranteed by the snapping of the insulator inner shoulder into the groove of the center contact. This design facilitates the captivation operation in contrast to other designs, requiring two insulators to provide contact retention.

It assures constant and perfect axial positioning of the center contact into the interface.

- **Space-saving size:**

Due to the captivation technique, these commercial SMA connectors are shorter than multi-piece body connectors.

- **Convenient 3-piece design:**

- For straight models: body + center contact + outer ferrule
- For right angle models: single piece body + back cap + outer ferrule

- **Fast and reliable cable attachment:**

The cable connectors can be either fully crimped or soldered/crimped, offering full flexibility for high volume industrial production with standard manual or pneumatic tooling: fast and reliable

- The center contact can be either crimped or soldered
- The outer contact is attached to the cable by crimping a ferrule

- **Competitive pricing:**

The design and materials used in the manufacturing of the Commercial SMA series allow us to offer connectors at competitive prices to suit a wide range of applications. The connector body is manufactured in brass and the surface plating is available in either gold or in BBR finish (Radiall non-magnetic bright bronze surface finish).

- **Center contact captivation:**

Our connectors have a captive center contact.

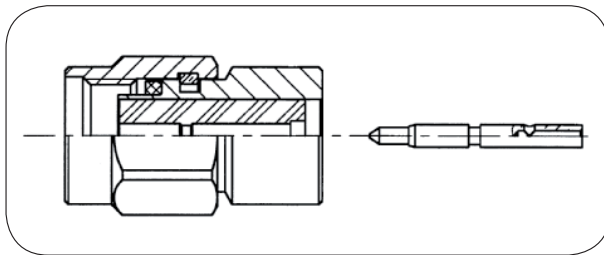

INTRODUCTION

SMA-COM



50Ω

DC - 18 GHz

GENERAL

- Subminiature coaxial connectors
- Screw-on coupling
- High RF performance
- 2 plating options:
 - BBR
 - Gold

APPLICABLE STANDARDS

- MIL-C-39012
- IEC 169-1
- CECC 22110
- CECC 22111 - 801 to 808
- BS 9210 N006



APPLICATIONS

- Telecommunications
- Aeronautics
- Measurement and test systems
- General electronics

8-33

www.radiall.com

RADIAL
The next conneXion



INTERFACE

PLUG

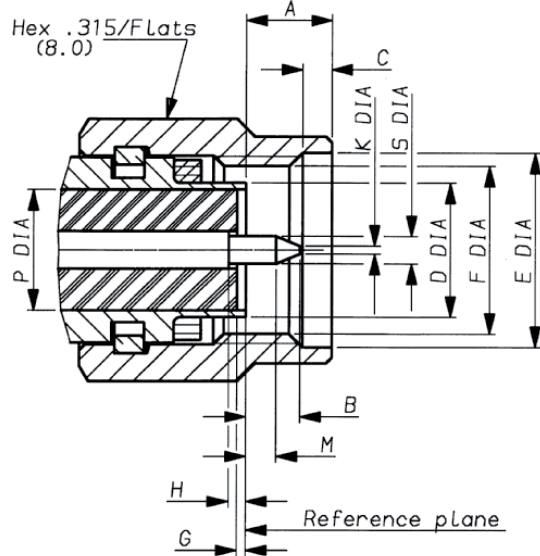

JACK

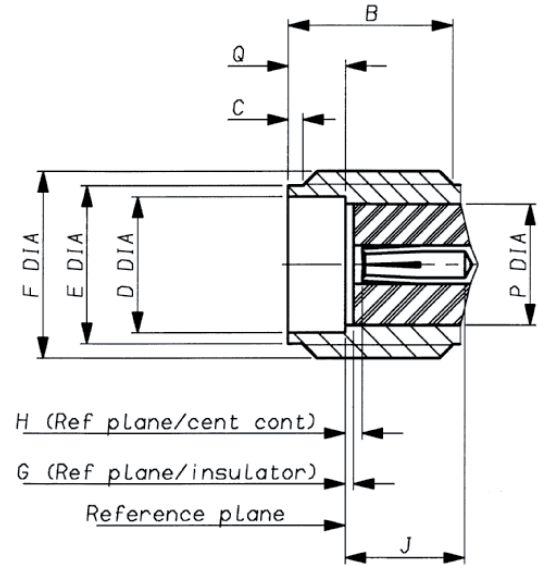

Letter	mm		inch	
	min.	max.	min.	max.
A		3.43		.135
B		2.54		.100
C	0.38	1.14	.015	.045
D DIA		4.59		
E DIA	6.35		.250	
F DIA	1/4 36 UNS 2B			
G*	0.0	-0.20	0.0	-.008
H*	0.0	-0.25	0.0	-.010
J				
K DIA		0.38		.015
M	1.27		.050	
P DIA	4.10 nom.		.161 nom.	
Q DIA				
S DIA	0.90	0.94	.035	.037

Letter	mm		inch	
	min.	max.	min.	max.
A				
B	4.31		.170	
C	0.38	1.14	.015	.045
D DIA	4.596		.181	
E DIA	5.28	5.49	.208	.216
F DIA	1/4 36 UNS 2A			
G*	0.0	-0.20	0.0	-.008
H*	0.0	-0.25	0.0	-.010
J	2.92		.115	
K				
M				
P DIA	4.10 nom.		.161 nom.	
Q	1.88	1.98	.074	.078
S DIA				

*Note: means behind ref plane

Test/characteristics	MIL-C-39012 paragraph	Values/remarks
----------------------	-----------------------	----------------

GENERAL

Impedance		50Ω	
Frequency range		Semi-rigid cables	Standard models
		DC - 18 GHz	DC - 12.4 GHz
Temperature range		- 65°C + 105°C	- 65°C + 165°C

ELECTRICAL CHARACTERISTICS

Insulation resistance	3-11	5 000 MΩ mini.			
Contact resistance	3-16	Initial	After test		
• Outer conductor		3 mΩ	4 mΩ		
• Inner conductor		2 mΩ	3 mΩ		
V.S.W.R. max up to: 18 GHz for semi-rigid cable 12.4 GHz for right angle connector (SR) 12.4 GHz for flexible cable	3-14	.085"	.141"	2.6/50/S	5/50/D
• Straight Connector		1.07 + .01F	1.05 + .01F	1.15 + .02F	1.15 + .01F
• Right angle connector		1.10 + .01F	1.10 + .01F	1.15 + .03F	1.15 + .02F
Dielectric withstanding voltage in VRMS	3-17	750	1000	750	1000
Working voltage in VRMS (sea level)		335	500	250	335
Working voltage in VRMS (70 000 ft)		85	125	65	85
RF testing voltage at 5 MHz in VRMS	3-23	500	670	500	670

MECHANICAL CHARACTERISTICS

Cable retention force	3-24	.085"	.141"	2.6/50/S	5/50/D
		130 N	270 N	90 N	204 N
Life	3-15	100 matings			
Force to engage and disengage	3-5-1	23 Ncm - 2 inch pounds			
Coupling nut torque recommended		60 Ncm - 5.2 inch pounds			
Coupling nut retention force	3-25	272 N min			

ENVIRONMENTAL CHARACTERISTICS

Vibration	3-18	MIL STD 202, method 204, condition D, 20g
Shock	3-19	MIL STD 202, method 213, condition I, 100g
Thermal shock	3-20	MIL STD 202, method 107, condition B.
Corrosion (salt spray)	3-13	MIL STD 202, method 101, condition B.
Moisture resistance	3-21	MIL STD 202, method 106
Barometric pressure	3-22	MIL STD 202, method 105, condition C
Hermetic test		Down to 10 ⁻⁶ mmHg (Torr) leakage rate < 10 ⁻⁸ atm/cm ³ /sec
Life (at high temperature)		MIL STD 202, method 108

MATERIALS AND PLATING

	Material	Plating
Bodies	Brass	BBR* or Gold plated
Center contacts	Beryllium copper (female) Brass (male)	Gold plated
Insulators	PTFE teflon	
Gaskets	Silicone rubber	

*BBR: Bright Bronze Radiall

All dimensions are given in mm

Standard packaging: 100 pieces.

PLUGS

STRAIGHT PLUGS, FULL CRIMP TYPE FOR FLEXIBLE CABLE

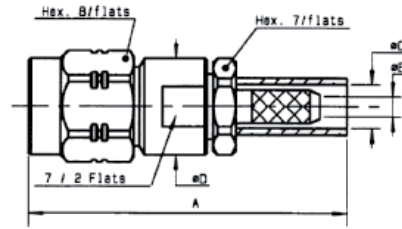

Fig. 1

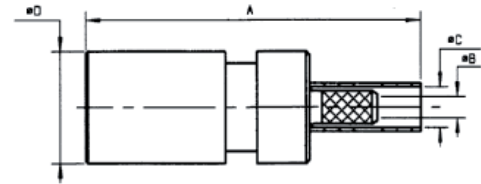

Fig. 2

Cable group	Cable group dia.	Part number	Fig	Dimensions (mm)				Finish	Note
				A	B	C	D		
RG178/RG196	2/50/S	R124 069 120	1	25	1	2.55	7.7	BBR	Back nut / solder contact
		R124 069 123						Gold	
RG174/RG316	2.6/50/S	R124 071 120	2	23.4	1.61	3.25	7.7	BBR	
		R124 071 123						Gold	
RD316	2.6/50/D	R124 072 220				3.5		BBR	
RG58/RG141	5/50/S	R124 075 320				5.41		Gold	
		R124 075 323						BBR	
RG142/RG223/RG400	5/50/D	R124 076 320		26.4	3.11			Gold	
		R124 076 323				5.8		Gold	

STRAIGHT PLUGS, SOLDER TYPE FOR SEMI-RIGID CABLE

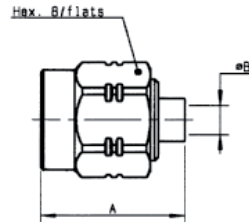

Fig. 1

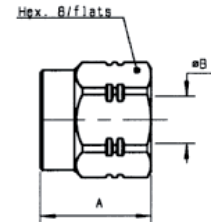

Fig. 2

Cable group	Cable group dia.	Part number	Fig	Dimensions (mm)		Finish	Note
				A	B		
RG405	.085"	R124 052 003	1	11.1	2.25	Gold	Non captivated center contact
RG402	.141"	R124 054 003	2	8.5	3.65		Without center contact
		R124 055 003	1	11.2			With center contact

RIGHT ANGLE PLUGS

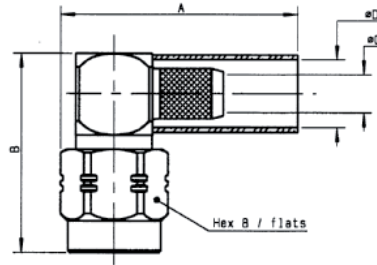

Fig. 1

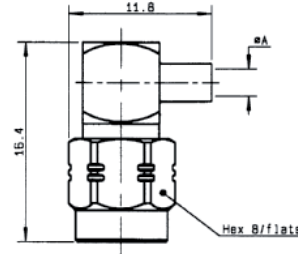

Fig. 2

Cable group	Cable group dia.	Part number	Fig	Dimensions (mm)				Finish	Note
				A	B	C	D		
RG174/RG316	2.6/50/S	R124 172 120	1	18	16.35	1.61	3.25	BBR	Crimp type for flexible cable
		R124 172 123					Gold		
RD316	2.6/50/D	R124 174 120					3.5	BBR	
		R124 174 123					Gold		
RG58/RG141	5/50/S	R124 175 120	21	3.1	5.41	BBR			
		R124 175 123			Gold				
RG142/RG223/RG400	5/50/D	R124 176 120	2	2.25	3.65	5.8	BBR	Solder type for semi-rigid cable	
		R124 176 123				Gold			
RG405	.085"	R124 153 003					Gold		
RG402	.141"	R124 154 003							

STRAIGHT JACKS

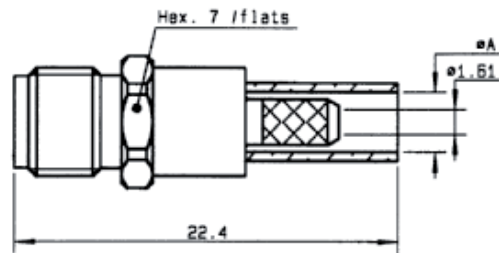

Fig. 1

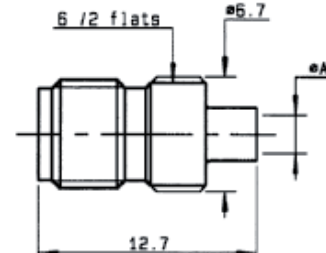

Fig. 2

Cable group	Cable group dia.	Part number	Fig	Dimensions (mm) A	Finish	Note
RG174/RG316	2.6/50/S	R124 236 123	1	3.25	Gold	Full crimp type for flexible cable
RD316	2.6/50/D	R124 233 123		3.5		
RG405	.085"	R124 222 003	2	2.25		Non captivated center contact solder type for semi-rigid cable
RG402	.141"	R124 225 003		3.65		

To download data sheets and assembly instructions, visit www.radiall.com & enter the part number in the Search box. **Bold** part numbers represent products typically in stock & available for immediate shipment. See page 8 and 9 for packaging information.

JACKS

BULKHEAD FEEDTHROUGH STRAIGHT JACKS, FULL CRIMP TYPE, FOR FLEXIBLE CABLE

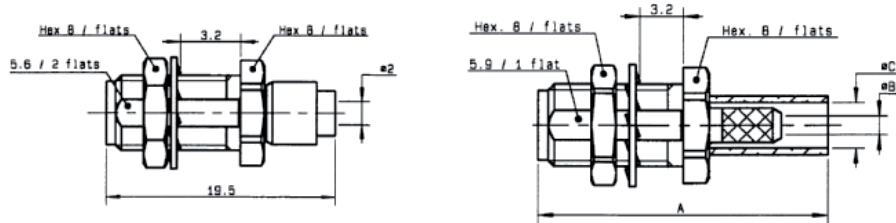
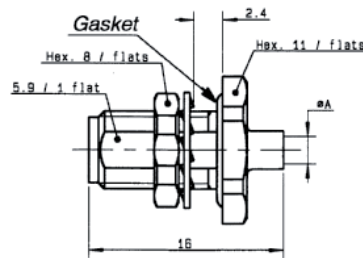

Fig. 1

Fig. 2

Cable group	Cable group dia.	Part number	Fig	Dimensions (mm)			Panel drilling	Finish	Note
				A	B	C			
RG178/RG196	2/50/S	R124 310 023	1				P07	Gold	Reverse crimping / solder contact
RG174/RG316	2.6/50/S	R124 312 120	2	22.4	1.61	3.25	P05	BBR	
		R124 312 123						Gold	
RG142/RG223/RG400	5/50/D	R124 315 123		25.4	3.11	5.8			

BULKHEAD FEEDTHROUGH STRAIGHT JACKS, SOLDER TYPE, FOR SEMI-RIGID CABLE - PANEL SEAL



Cable group	Cable group dia.	Part number	Dimensions A (mm)	Panel drilling	Finish	Note
RG405	.085"	R124 326 003	2.25	P05	Gold	Non captivated center contact
RG402	.141"	R124 325 003	3.65			

FLANGE JACKS, SOLDER TYPE FOR SEMI-RIGID CABLE

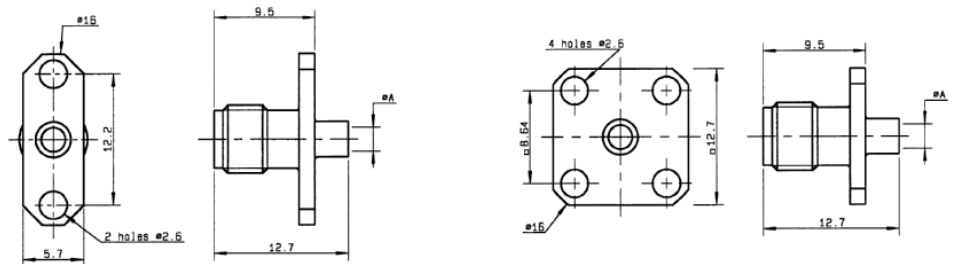

Fig. 1

Fig. 2

Cable group	Cable group dia.	Part number	Fig	Dimensions A (mm)	Panel drilling	Finish	Note
RG405	.085"	R124 252 003	1	2.25	P04	Gold	Non captivated center contact
		R124 256 003	2		P02		
RG402	.141"	R124 251 003	1	3.65	P04		
		R124 255 003	2		P02		

SQUARE FLANGE FEMALE RECEPTACLES

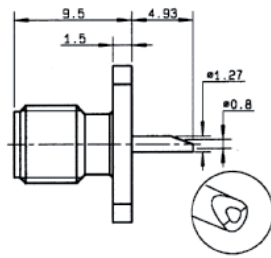
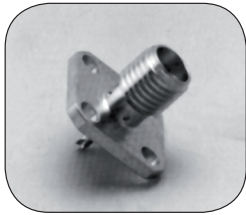

Fig. 1

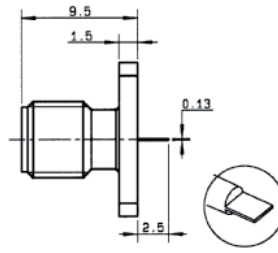

Fig. 2

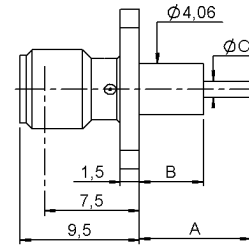

Fig. 3

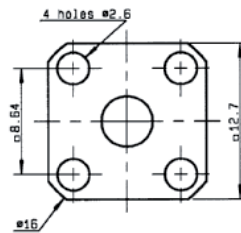

Fig. 1 to 3

Part number	Fig	Dimensions (mm)			Panel drilling	Finish	Note
		A	B	C			
R124 403 123	1				P01	Gold	4 Indents
R124 413 025	3	8.9	5.1	1.28			
R124 414 003		15.9	12.7	1.27			
R124 415 273		17.9	15				
R124 510 000	2						

NARROW FLANGE FEMALE RECEPTACLES

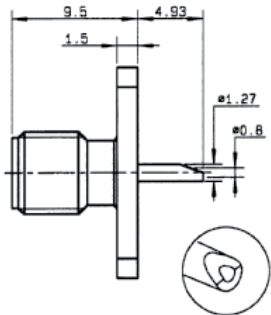

Fig. 1

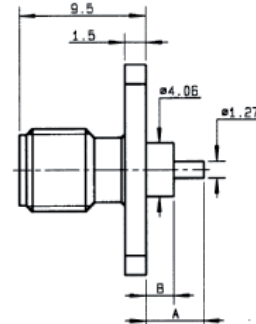
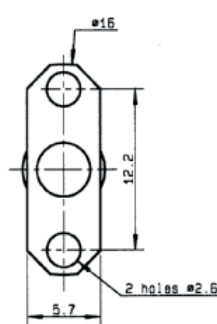

Fig. 2

Part number	Fig	Dimensions (mm)		Panel drilling	Finish	Note
		A	B			
R124 454 123	1			P04	Gold	4 Indents
R124 464 000	2	15.9	12.7		BBR	

To download data sheets and assembly instructions, visit www.radiall.com & enter the part number in the Search box. **Bold** part numbers represent products typically in stock & available for immediate shipment. See page 8 and 9 for packaging information.

RECEPTACLES AND SWITCHES

RIGHT ANGLE SQUARE FLANGE FEMALE RECEPTACLES

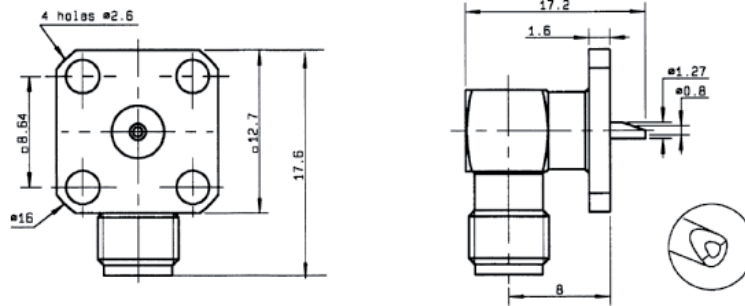

Part number	Panel drilling	Finish
R124 654 003	P02	Gold

STRAIGHT FEMALE PCB RECEPTACLES AND SWITCHES

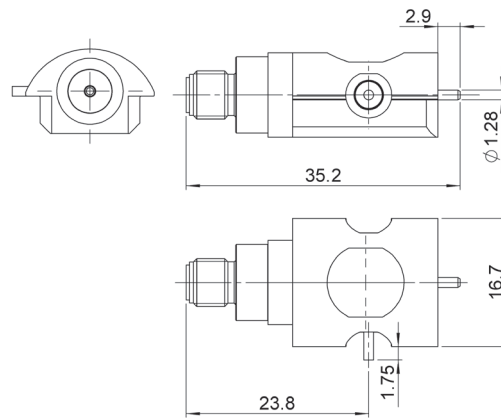
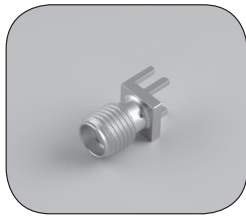

Fig. 1

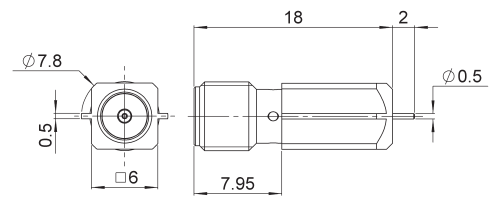

Fig. 2

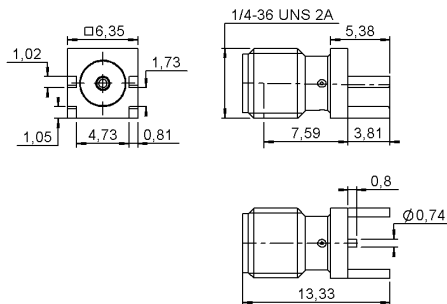

Fig. 3

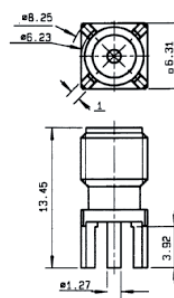

Fig. 4

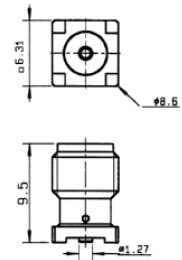

Fig. 5

Part number	Fig	Panel drilling	Assembly instructions	Finish	Note
R124 422 001	1		M03	Gold	Switch edge card SMT - Right type - packaging in reel 110 pieces
R124 423 033	2		M02		SMT edge card type - packaging: unit
R124 423 223	3				
R124 426 120	4	P03		BBR	
R124 426 123	4				
R124 427 000	5		M01	Gold	Surface mount / bulkhead 100 pieces
R124 427 800					Surface mount / Tape and reel of 100 pieces

RIGHT ANGLE FEMALE PCB RECEPTACLES

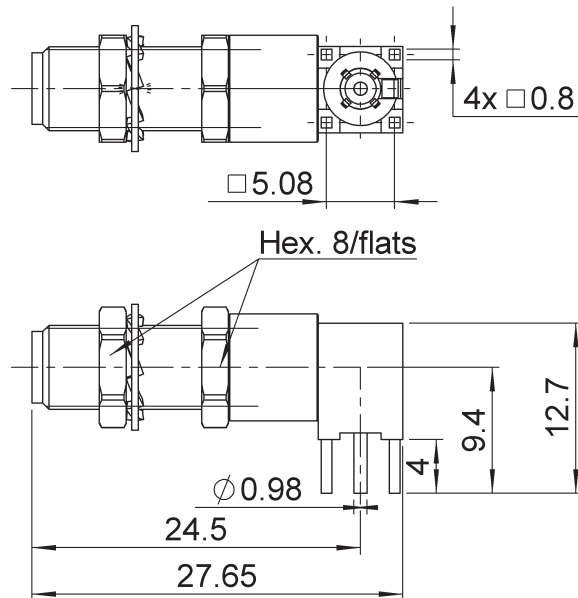
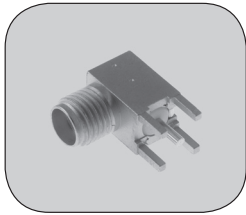

Fig. 1

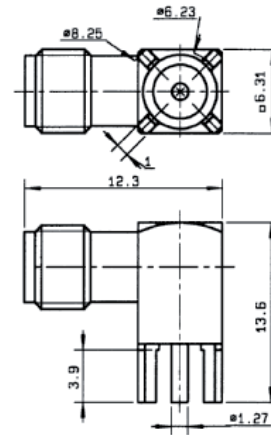

Fig. 2

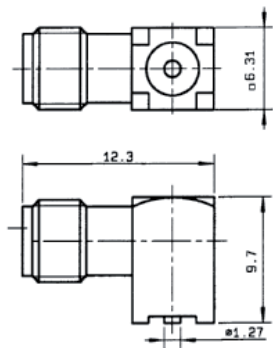

Fig. 3

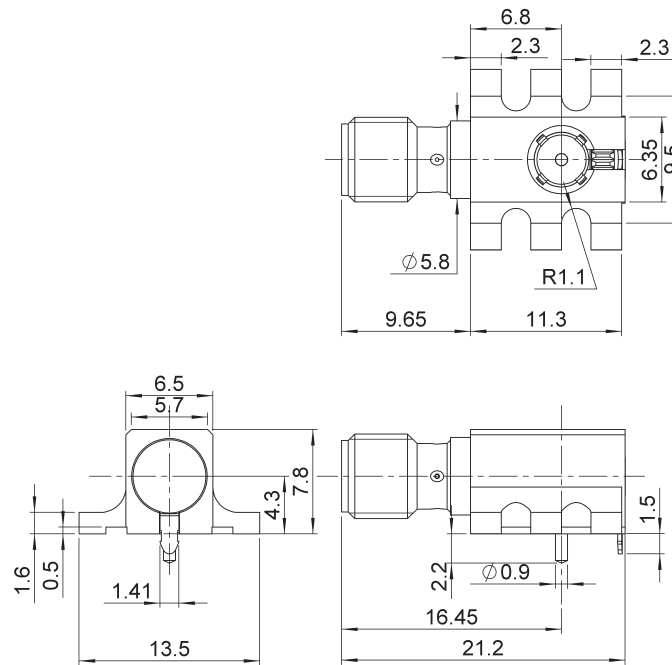

Fig. 4

Part number	Fig	Panel drilling	Assembly instructions	Finish	Note
R124 667 143	1	P08		Gold	Packaging: tray of 60 pieces
R124 680 120	2	P03		BBR	Surface mount / bulkhead 100 pieces
R124 680 123				Gold	
R124 681 000	3		M01	GBR	Packaging: 250 pieces
R124 682 820	4		M04		

To download data sheets and assembly instructions, visit www.radiall.com & enter the part number in the Search box.
Bold part numbers represent products typically in stock & available for immediate shipment.
 See page 8 and 9 for packaging information.

ADAPTERS

IN SERIES ADAPTERS

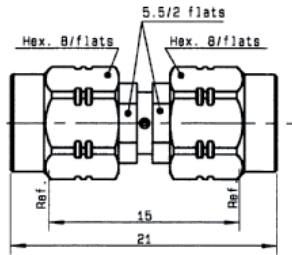

Fig. 1

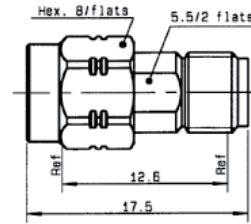

Fig. 2

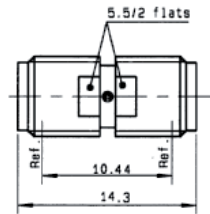

Fig. 3

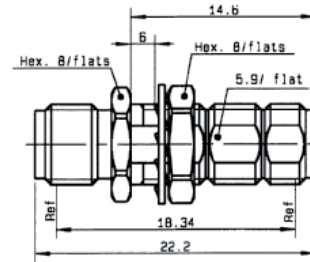
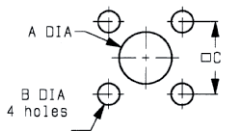

Fig. 4

Part number	Fig	Panel drilling	Finish	Note
R124 703 003	1		Gold	Plug to plug
R124 704 003	2			Plug to jack
R124 705 003	3			Jack to jack
R124 720 003	4	P05		

PANEL DRILLING

P01



	MM		INCH	
	maxi	mini	maxi	mini
A	4.2	4.1	0.165	0.161
B	2.7	2.6	0.106	0.102
C	8.69	8.59	0.342	0.338

P02

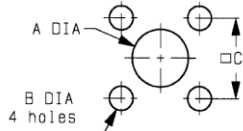

	MM		INCH	
	maxi	mini	maxi	mini
A	6.6	6.5	0.26	0.256
B	2.7	2.6	0.106	0.102
C	8.69	8.59	0.342	0.338

P03

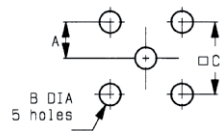

	MM		INCH	
	maxi	mini	maxi	mini
A	2.59	2.49	0.102	0.098
B	1.7	1.6	0.067	0.063
C	5.13	5.03	0.202	0.198

P04

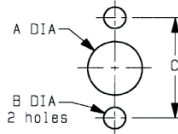

	MM		INCH	
	maxi	mini	maxi	mini
A	4.2	4.1	0.165	0.161
B	2.7	2.6	0.106	0.102
C	12.25	12.15	0.482	0.478

P05

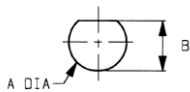

	MM		INCH	
	maxi	mini	maxi	mini
A	6.5	6.4	0.256	0.252
B	6.15	6	0.242	0.236

P06

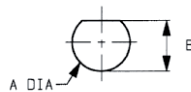

	MM		INCH	
	maxi	mini	maxi	mini
A	5	4.9	0.197	0.193
B	4.7	4.55	0.185	0.179

P07

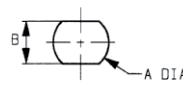

	MM		INCH	
	maxi	mini	maxi	mini
A	6.5	6.4	0.256	0.252
B	5.6	5.7	0.224	0.224

P08



	mm	
	Maxi	mini
A	6.40	6.35

PACKAGING

SMA-COM

Part number	Fig
R124 422 001	1
R124 423 833	2
R124 427 800	3

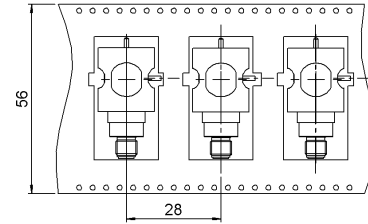
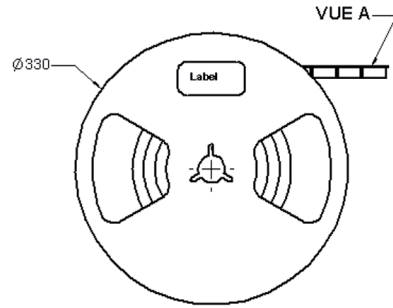

Fig. 1

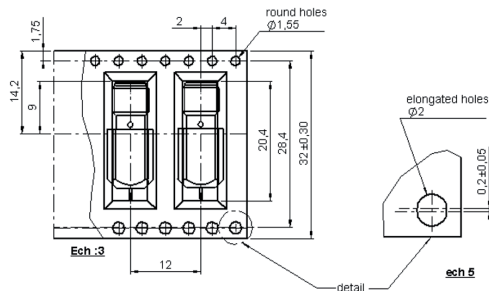

Fig. 2

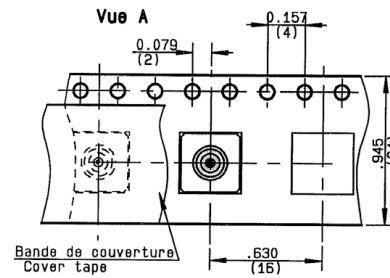

Fig. 3

ASSEMBLY INSTRUCTIONS

M01

Part number	
R124 427 000 R124 427 800	R124 681 000

SOLDERING PATTERN

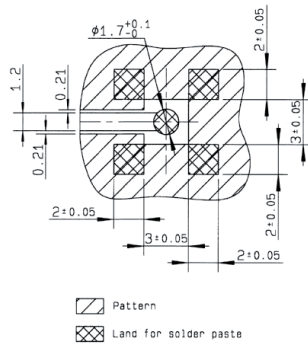

COPLANAR LINE

Pattern and signal are on the same side.
Thickness of PCB: 1.6 mm.
The PCB material is made of epoxy resin of glass fabrics bacs (Er = 4.8).
The solder resist should be printed except for the land pattern on the PCB.

ASPIRATION PORT

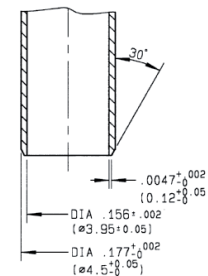

VIDEO SHADOWS

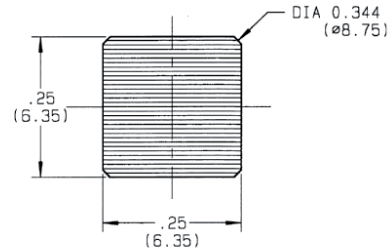
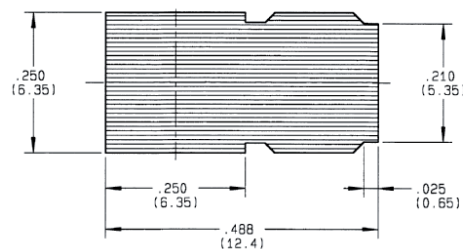

SMA 2.9 series is compatible with K[®] series, 2.92 mm, SMA and SMA 3.5 series and has a shortened male center contact, ensuring a non destructive mating.

Radiall offers four product variations for SMA 2.9 to meet all your needs with two different designs. The standard design is using our “ULTEM” insulator technology and is qualified up to 40 GHz. The high frequency design is using our “KAPTON” insulator technology and is qualified up to 46 GHz. All versions feature the same electrical high performance and are available in a variety of configurations.

• SMA 2.9 FOR GENERAL USE, “ULTEM” TECHNOLOGY, DC-40 GHz

This robust design is suitable for most applications. The ULTEM insulator provides a high ingress protection level against chemicals, fluids or dust and is well suited for high frequency aerospace and military equipment.

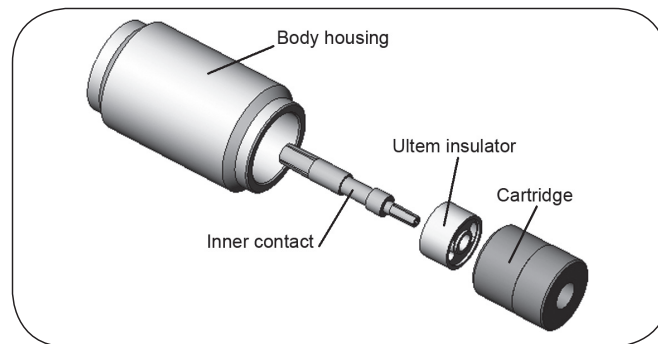

3D view of SMA 2.9 “ULTEM” design

• SMA 2.9 FOR TEST LABORATORY USE, “KAPTON” TECHNOLOGY, DC-46 GHz

The KAPTON insulator design is excellent for high frequency measurements in test laboratories. KAPTON is also very stable with temperature. Radiall SMA 2.9 adapters using KAPTON are specified DC-46 GHz and operate within a large temperature range - 65°C/+200°C.

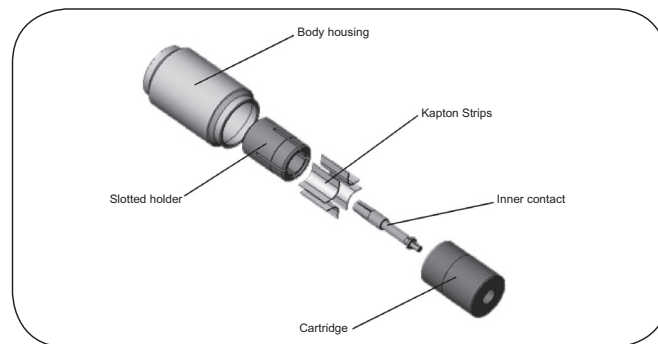

3D view of SMA 2.9 “KAPTON” design

• SMA 2.9 FOR SPACE APPLICATIONS

Radiall is a certified manufacturer of connectors for space applications according to ESA specifications. A range of space qualified SMA 2.9 connectors using the ULTEM insulator technology is available. Please consult us.

• SMA 2.9 FOR HARSH ENVIRONMENT

Radiall offers as well a range of cable assemblies equipped with specific connectors for applications in harsh environment. The connectors are made of high grade stainless steel 316L ultra resistant to corrosion and wear. Please consult us.

INTERFACE

JACK

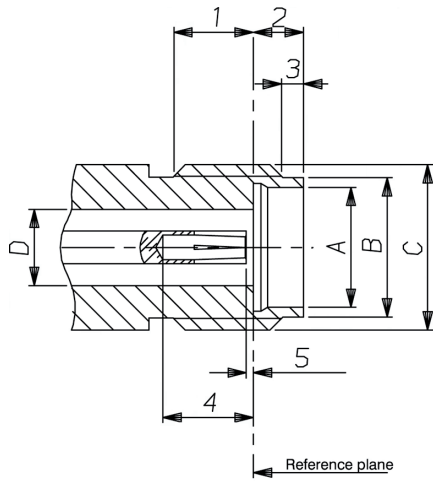

PLUG

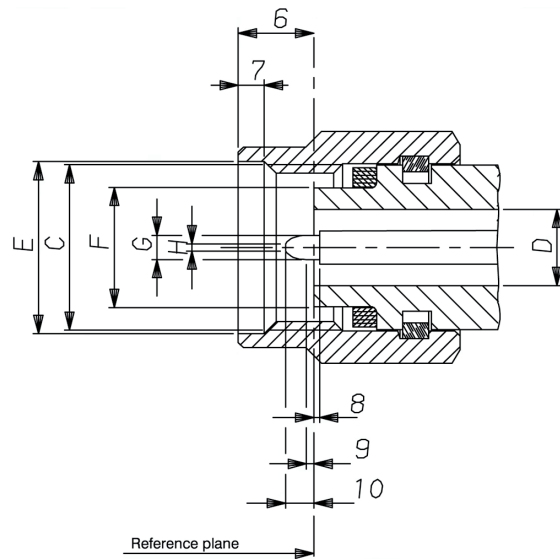

Letter or Figure	mm		inch	
	min.	max.	min.	max.
1	2.87	3.27	.113	.129
2	1.88	1.98	.074	.078
3	0.65	0.95	.026	.037
4	2.40	2.68	.094	.105
5		0.08		.003
A	4.60	4.63	.181	.182
B	5.30	5.35	.209	.211
C	1/4 - 36 UNS 2A			
D	2.90	2.94	.114	.116

Letter or Figure	mm		inch	
	min.	max.	min.	max.
6	2.63	3.25	.103	.128
7	0.90	1.10	.035	.043
8		0.08		.003
9	0.49	0.78	.019	.031
10	1.22	1.40	.048	.055
C	1/4 - 36 UNS 2B			
D	2.90	2.94	.114	.116
E	6.60	6.70	.260	.264
F	4.55	4.58	.179	.180
G	0.92	0.94	.036	.037
H	0.20	0.34	.008	.013

CHARACTERISTICS

SMA 2.9

Test/characteristics	Values/remarks	
	ULTEM technology	KAPTON technology

ELECTRICAL CHARACTERISTICS

Impedance	50Ω	
Frequency range	DC - 40 GHz	DC - 46 GHz
V.S.W.R.	< 1.05 + 0.005 F (GHz)	
Insertion loss	0.03 √ F (GHz)	
RF leakage	- 90 dB max	
Insulation resistance	≥ 5000 mΩ	
Contact resistance	≤ 2 mΩ	
• outer conductor	straight ≤ 3 mΩ	
• inner conductor	hermetic ≤ 7 mΩ	
Voltage rating	350 V(RMS)	
Dielectric withstanding voltage	750 V(RMS)	

MECHANICAL CHARACTERISTICS

Mechanical endurance	500 matings
Force to engage and disengage	≤ 23 N cm (2 in/lbs)
Mating torque	80 to 115 N cm (7 to 10 in/lbs)
Coupling nut retention force	≤ 272 N (61 lbf)
Cable retention force • .085"	135 N (30 lbf)
• .141"	270 N (60 lbf)
Contact captivation	28N (6.3 lbf)

ENVIRONMENTAL CHARACTERISTICS

Temperature range	-65°C / + 165°C	-65°C / +200°C
Thermal shock	MIL STD 202, method 107, condition B	
High temperature test	MIL STD 202, method 108	
Corrosion (salt spray)	MIL STD 202, method 101, condition B, 5 %	
Vibration	MIL STD 202, method 204, condition D, 20g	
Shock	MIL STD 202, method 213, condition I, 100g	
Moisture resistance	MIL STD 202, method 106	

MATERIALS AND PLATING

	Material	Plating
Bodies	Stainless steel	Passivated
Center contacts	Beryllium copper	Gold plated
Gaskets	Silicone rubber	
Insulators	Ultem (Ultem technology) Kapton (Kapton technology)	

Packaging: unit

All dimensions are given in mm (inch)

PLUGS

STRAIGHT PLUGS, SOLDER TYPE FOR MICROPOROUS SEMI-RIGID CABLES

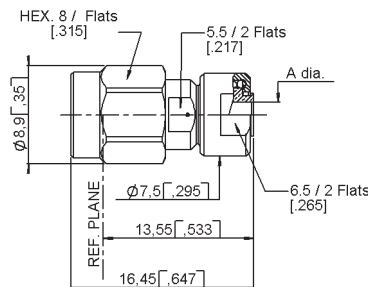

Cable group	Cable group dia.	Part number	Insulator	Dimension A (mm)	Captive center contact	Frequency range
RG405	.085" microporous	R127 800 001	ULTEM	2.25	yes	DC - 40 GHz
RG402	.141" microporous	R127 800 101		3.66		
RG405	.085" microporous	R127 052 001	KAPTON	2.2		DC - 46 GHz
	.116" microporous	R127 055 001		3.0		

To download data sheets and assembly instructions, visit www.radiall.com & enter the part number in the Search box.
Bold part numbers represent products typically in stock & available for immediate shipment.
 See page 8 and 9 for packaging information.

8-47

JACKS AND RECEPTACLES

STRAIGHT JACKS, SOLDER TYPE FOR MICROPOROUS SEMI-RIGID CABLES

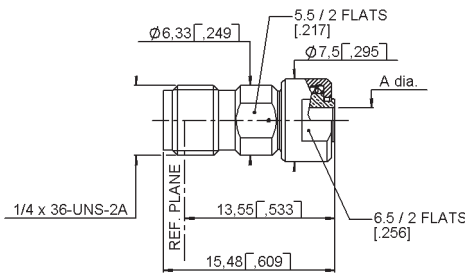

Cable group	Cable group dia.	Part number	Insulator	Dimension A (mm)	Captive center contact	Frequency range
RG405	.085" microporous	R127 820 001	ULTEM	2.25	yes	DC - 40 GHz

UNIVERSAL SCREW-ON FEMALE RECEPTACLES

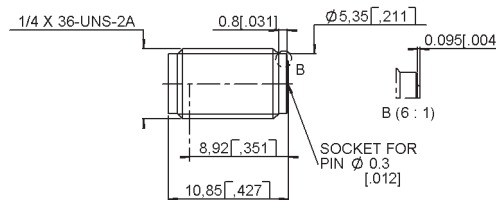
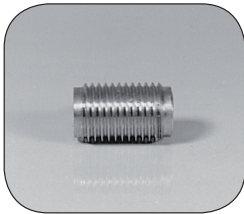

Part number	Insulator	Frequency range	Used with glass bead	For pin diameters
R127 841 001	ULTEM	DC - 40 GHz	R280 760 040	0.3 (.012)
R127 601 001	KAPTON	DC - 46 GHz		

FLANGE FEMALE RECEPTACLES

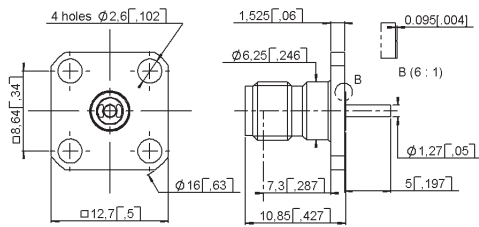
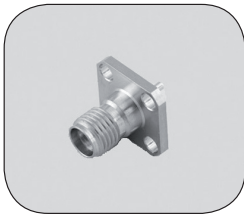

Fig. 1

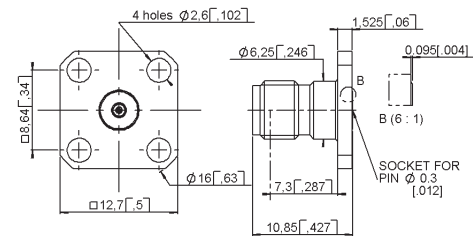

Fig. 2

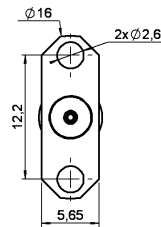
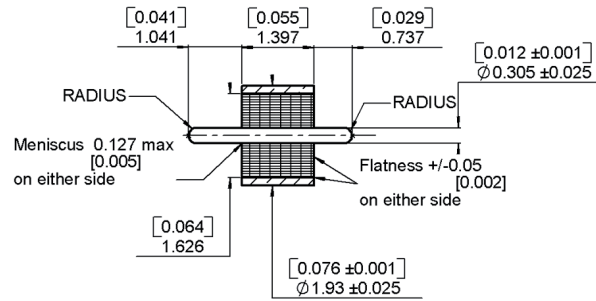
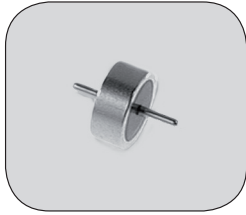

Fig. 3

Part number	Fig	Insulator	Captive center contact	Panel drilling	Used with glass bead	Note
R127 840 021	1	ULTEM	yes	P02	N/A	with cylindrical center contact
R127 842 001	2			P01	R280 760 040	For pin dia 0.3 (.012)
R127 631 001	3	KAPTON				
R127 632 001						

GLASS BEAD



Part number	Packaging
R280 760 040	100

IN SERIES ADAPTERS

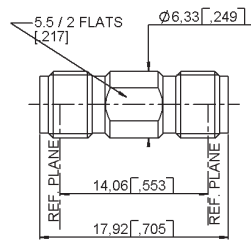

Fig 1

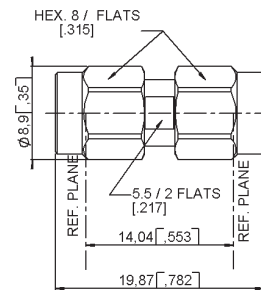

Fig 2

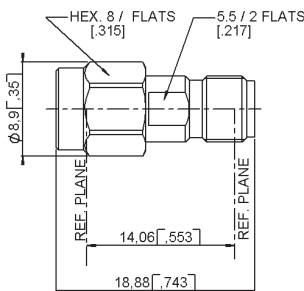

Fig 3

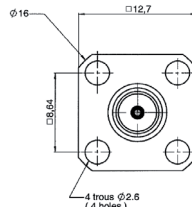

Fig 4

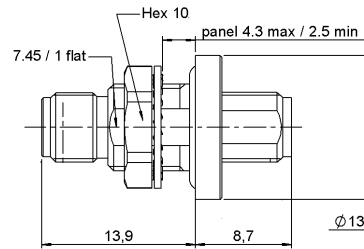

Fig 5

Part number	Fig	Insulator	Note	Frequency range
R127 703 001	2	KAPTON	Male-male	DC - 46 GHz
R127 704 001	3		Female-male	
R127 705 001	1		Female-female	
R127 712 001	4		Female-female - 4 hole flange	
R127 753 000	5		Female-female - bulkhead hermetic	
R127 870 001	1	ULTEM	Female-female	DC - 40 GHz
R127 872 001	3		Female-male	

To download data sheets and assembly instructions, visit www.radiall.com & enter the part number in the Search box. **Bold** part numbers represent products typically in stock & available for immediate shipment. See page 8 and 9 for packaging information.

BETWEEN SERIES ADAPTERS

BETWEEN SERIES ADAPTERS

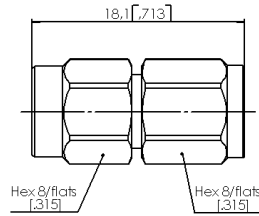
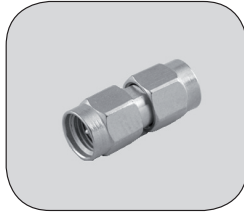

Fig. 1

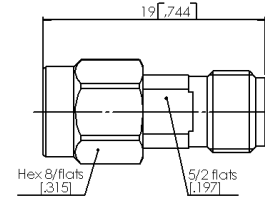

Fig. 2

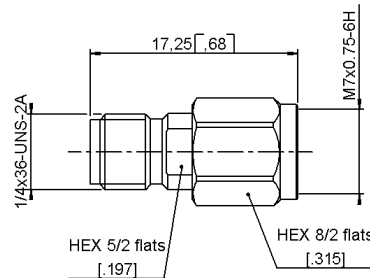

Fig. 3

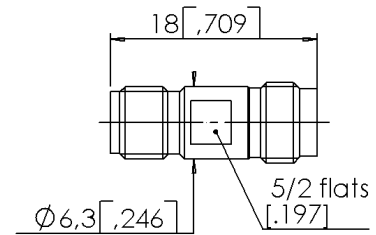

Fig. 4

Part number	Fig	Insulator	Note	Frequency range
R191 970 061	1	KAPTON	SMA 2.9 Male - SMA 2.4 Male	DC - 46 GHz
R191 970 071	2		SMA 2.9 Male - SMA 2.4 Female	
R191 970 081	3		SMA 2.9 Female - SMA 2.4 Male	
R191 970 091	4		SMA 2.9 Female - SMA 2.4 Female	

Remark: these adapters are still using the previous technology (4 kapton strips) allowing to reach 46 GHz within a temperature range of - 65 °C/+ 200 °C.

PANEL DRILLING

P01

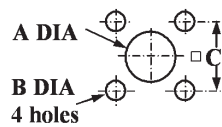

	mm		inch	
	maxi	mini	maxi	mini
A	1.63	1.60	.064	.063
B	2.70	2.60	.106	.102
C	8.69	8.59	.342	.338

P02

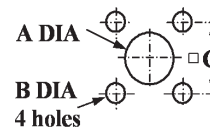

	mm		inch	
	maxi	mini	maxi	mini
A	2.95	2.91	.116	.115
B	2.7	2.6	.106	.102
C	8.69	8.59	.342	.338

Cable designation	Cable Group Ø / Ω	Imp. Ω	Cable dimensions mm (inch)					Radiall cable if applicable		
			Core type	Core Ø	Insulator Ø	Screen	Outer Ø	P/N	Remark	
RG 174 A/U	2.6 / 50 S	50	7 x 0.16	0.48 (.019)	1.52 (.060)	S	2.79 (.110)	C291 150 000	PVC jacket	
RG 178 B/U	2 / 50 S	50	7 x 0.1	0.30 (.012)	0.84 (.033)	S	1.78 (.070)	C291 145 007	FEP jacket	
RG 178 B/U	2 / 50 S	50	7 x 0.1	0.30 (.012)	0.84 (.033)	S	1.83 (.072)	C291 145 060	PVC jacket	
RG178nonm.	2 / 50 S	50	7 x 0.1	0.29 (.011)	0.84 (.033)	S	1.80 (.071)	C291 140 087	non magnetic / FEP jacket	
RG 179 B/U	2.6 / 75 S	75	7 x 0.1	0.30 (.012)	1.60 (.063)	S	2.54 (.010)	C291 210 007	FEP jacket	
RG 187 A/U	2.6 / 75 S	75	7 x 0.1	0.30 (.012)	1.60 (.063)	S	2.79 (.110)	C291 211 006	PTFE jacket	
RG 188 A/U	2.6 / 50 S	50	7 x 0.17	0.51 (.020)	1.52 (.060)	S	2.79 (.110)	C291 160 006	PTFE jacket	
RG 196 A/U	2 / 50 S	50	7 x 0.1	0.30 (.012)	0.86 (.034)	S	2.03 (.080)	C291 110 006	PTFE jacket	
RG 212 /U	8 / 50 D	50	solid	1.41 (.056)	4.70 (.185)	D	8.43 (.331)	na		
RG 213 /U	10 / 50 S	50	7 x 0.75	2.26 (.089)	7.24 (.285)	S	10.30 (.406)	C291 510 000	PVC jacket	
RG 214 /U	11 / 50 D	50	7 x 0.75	2.25 (.089)	7.24 (.285)	D	10.80 (.425)	C291 600 000	PVC jacket	
RG 215	10 / 50 S	50	7 x 0.75	2.25 (.089)	7.25 (.285)	S	10.29 (.405)	na		
RG 216 /U	11 / 75 D	75	7 x 0.4	1.21 (.048)	7.24 (.285)	D	10.80 (.425)	C291 610 000	PVC jacket	
RG 217 /U	14 / 50 D	50	solid	2.69 (.106)	9.40 (.370)	D	13.84 (.545)	C291 620 000	PVC jacket	
RG 218 /U	22 / 50 S	50	solid	4.95 (.195)	17.27 (.680)	S	22.10 (.870)	C291 630 000	PVC jacket	
RG 223 /U	5 / 50 D	50	solid	0.89 (.035)	2.95 (.116)	D	5.38 (.212)	C291 330 000	PVC jacket	
RG 225 /U	11 / 50 D	50	7 x 0.8	2.38 (.094)	7.24 (.285)	D	10.90 (.429)	C291 605 007	glass fiber jacket	
RG 303 /U	5 / 50 S	50	solid	0.94 (.037)	2.95 (.116)	S	4.32 (.170)	na		
RG 316 /U	2.6 / 50 S	50	7 x 0.17	0.53 (.021)	1.52 (.060)	S	2.49 (.098)	C291 170 007	FEP jacket	
RD 316	2.6 / 50 D	50	7 x 0.17	0.53 (.021)	1.52 (.060)	D	2.80 (.110)	C291 185 067	FEP jacket	
RG 393	10 / 50 D	50	7 x 0.81	2.39 (.094)	7.24 (.285)	D	9.91 (.390)	C291 511 007	FEP jacket	
RG 400	5 / 50 / D	50	19 x 0.19	0.98 (.039)	2.95 (.116)	D	4.95 (.195)	C291 324 007	FEP jacket	
Flexible cable BT approved										
RD 179	2.6 / 75 D	75	7 x 0.10	0.30 (.012)	1.6 (.063)	D	3.07 (.121)	C291 230 080	LSOH jacket	
BT 3002	3.6 / 75 D	75	solid	0.31 (.012)	1.95 (.077)	D	3.55 (.140)	C291 246 046	FEP jacket	
BT 2002	5 / 75 D	75	7 x 0.20	0.60 (.024)	2.5 (.098)	D	5.1 (.200)	C291 333 080	FEP jacket	
Semi rigid cables MIL-C-17 standard										
RG 401 /U	.250"	50	solid	1.63 (.064)	5.31 (.209)	--	6.35 (.250)	C291 870 001	copper tubing	
RG 401 alu	.250"	50	solid	1.63 (.064)	5.31 (.209)	--	6.35 (.250)	C291 874 187	tinned alu tubing	
RG 402 /U	.141"	50	solid	0.92 (.036)	2.98 (.117)	--	3.58 (.141)	C291 860 001	copper tubing	
RG 402 tin	.141"	50	solid	0.92 (.036)	2.98 (.117)	--	3.58 (.141)	C291 862 005	tinned copper tubing	
RG402silver	.141"	50	solid	0.92 (.036)	2.98 (.117)	--	3.58 (.141)	C291 861 066	silvered copper tubing	
RG 402 alu	.141"	50	solid	0.92 (.036)	2.98 (.117)	--	3.58 (.141)	C291 864 187	tinned alu tubing	
RG402nonm.	.141"	50	solid	0.92 (.036)	2.98 (.117)	--	3.58 (.141)	C291 861 061	non magnetic / copper tubing	
RG 405 /U	.085"	50	solid	0.51 (.020)	1.68 (.066)	--	2.20 (.087)	C291 850 001	copper tubing	
RG 405 tin	.085"	50	solid	0.51 (.020)	1.68 (.066)	--	2.20 (.087)	C291 850 005	tinned copper tubing	
RG 405 alu	.085"	50	solid	0.51 (.020)	1.68 (.066)	--	2.20 (.087)	C291 844 187	tinned alu tubing	
RG405nonm.	.085"	50	solid	0.51 (.020)	1.68 (.066)	--	2.20 (.087)	C291 851 001	non magnetic / copper tubing	
.047"	.047"	50	solid	0.29 (.011)	0.94 (.037)	--	1.19 (.047)	C291 855 001	copper tubing	
.047" tin	.047"	50	solid	0.29 (.011)	0.94 (.037)	--	1.19 (.047)	C291 855 065	tinned copper tubing	
Hand-formable cable										
Hand-formable	.085"	50	solid	0.51 (.020)	1.63 (.064)	--	2.21 (.087)	C291 844 065	tin soaked braid	
Hand-formable	.141"	50	solid	0.92 (.036)	2.95 (.116)	--	3.50 (.138)	C291 864 065	tin soaked braid	
Hand-formable	.141"	50	solid	0.92 (.036)	2.98 (.117)	--	4.05 (.159)	C291 866 378	FEP jacket	
Hand-formable	.141"	50	solid	0.92 (.036)	2.98 (.117)	--	4.50 (.177)	C291 866 270	LSZH jacket	
Corrugated cables (with helical or ringed/annular copper tube)										
Flexible	1/4"	50	solid	2.38 (.094)	6.40 (.252)	--	8.70 (.343)	na	ringed/annular tube	
Flexible	1/2"	50	solid	4.80 (.189)	11.6 (.457)	--	16.35 (.644)	C291 972 085	ringed/annular tube	
Flexible	7/8"	50	solid	9.13 (.359)	22.5 (.866)	--	27.7 (1.091)	na	ringed/annular tube	
Flexible	1 1/4"	50	solid	12.7 (.500)	32.5 (1.28)	--	39.5 (1.55)	na	ringed/annular tube	
Flexible	1 5/8"	50	solid	17.3 (.681)	43.5 (1.71)	--	50.5 (1.99)	na	ringed/annular tube	
Super flexible	1/4"	50	solid	1.90 (.075)	4.70 (.185)	--	7.40 (.291)	C291 993 080	helical tube	
Super flexible	3/8"	50	solid	2.60 (.102)	6.30 (.248)	--	10.8 (.425)	C291 996 070	helical tube	
Super flexible	1/2"	50	solid	3.60 (.142)	8.70 (.343)	--	13.2 (.520)	C291 994 080	helical tube	
Super flexible	7/8"	50	tube	9.04 (.356)	23.62 (.930)	--	27.48 (1.082)	C291 996 580	helical tube	

Note: S = single braid. D = dual braid.

For more information about cables manufactured by Radiall, please consult our online catalog.

www.radiall.com

X-ON Electronics

Largest Supplier of Electrical and Electronic Components

Click to view similar products for [RF Adapters - In Series](#) category:

Click to view products by [Radiall](#) manufacturer:

Other Similar products are found below :

[5916-1103-603](#) [5919-1503-000](#) [651A505](#) [82-5552](#) [9030-9523-502](#) [PN2C](#) [A0407000](#) [R114703000W](#) [R125771001](#) [R141710000W](#)
[R141723161](#) [R141730000](#) [R143730700](#) [R143770000](#) [R161703000W](#) [R161753000W](#) [R161791530W](#) [R201705000](#) [R222705200](#)
[R222M40010W](#) [R223703180](#) [R316754000](#) [R405006000](#) [R443162000](#) [AD78TL](#) [HRM-513S](#) [1996352-2](#) [2157155-1](#) [252169-75](#) [AD158](#)
[2101130-1](#) [252186](#) [R114704000W](#) [R114720000W](#) [R125705001](#) [R125705701](#) [R125771000](#) [R125771001W](#) [R127704001](#) [R127.870.001](#)
[R127872001](#) [R141717000](#) [R142710000](#) [R142723000](#) [R143703000](#) [R143704000](#) [R143705700](#) [R161715000W](#) [R161771000W](#) [R176754000](#)