



BNC / BNC 75 HDTV / BNC-TRX series

R141 / R142 / R266

RADIALL 
The next connexion

	Pages
Introduction	10-4 to 10-5
Interfaces	10-6 to 10-7
Characteristics	10-8 to 10-11
Finder guide	10-12 to 10-13
 BNC 75 HDTV	
Plugs	10-14
Jacks	10-14
Receptacles	10-15
Adapters	10-15
 BNC 50Ω	
Plugs	10-16 to 10-17
Jacks	10-17 to 10-19
Receptacles	10-20 to 10-22
Adapters	10-23 to 10-24
Accessories	10-24
Additional connectors	10-31
 BNC 75Ω	
Plugs	10-25 to 10-26
Jacks	10-26 to 10-28
Receptacles	10-28 to 10-29
Adapters	10-30
Additional connectors	10-31
 BNC-TRX	
Characteristics	10-32
Plug	10-32
Jack	10-32
Receptacle	10-32
 Panel drilling	 10-33 to 10-34

INTRODUCTION



50Ω	DC - 4 GHz DC - 1.5 GHz (commercial) DC - 1.0 GHz (Eco) DC - 10 GHz (TRIAxIAL)
75Ω	DC - 1.5 GHz DC - 6 GHz (HDTV) DC - 1.0 GHz (Eco)

GENERAL

- Worldwide standardised coaxial connectors
- Bayonet coupling
- Proven strength and reliability
- Good RF performance

APPLICABLE STANDARDS

- MIL-C-39012 / MIL STD 348-A/301
- IEC 169-8
- CECC 22120
- NF-C-93564 KBN series
- UTE-C-93564

APPLICATIONS

- Civil and military radio-telecommunication equipment
- Test and measurement
- Videocommunication
- Broadcast
- Industrial network
- General electronics

The BNC connector is the most popular coaxial connector series in the world, featuring a two-pin bayonet coupling system for quick and reliable engagement and disengagement.

• Wide range:

RADIALL's BNC connectors are available with two characteristic impedances: 50Ω and 75Ω. They are completely intermateable. RADIALL also offers low-cost- BNC range, and a triaxial BNC TRX series.

• Convenient three piece design:

Straight and right angle crimp type cable connectors feature a three piece design: single piece body + center contact + outer ferrule.



- **Fast and reliable cable attachment**

Cable connectors can be either fully crimped or soldered/crimped, offering full flexibility for fast, reliable, high-volume production with standard manual or pneumatic tooling.

- The center contact can be either crimped or soldered,
- The outer contact is attached to the cable by crimping a ferrule.

NEW: BNC 75 HDTV CONNECTOR SERIES WITH PERFORMANCE UP TO 6 GHz

Radiall's affordable "True" BNC 75 ohm HDTV Coaxial Connector Series can handle data rates up to 3 Gbps or higher, while supporting the broadcast industry's SMPTE 292M and 424M standards. Radiall is the only company that outperforms the rest with connectors that feature gold plated center and outer contacts. These provide outstanding electrical performance with a frequency range of up to 6 GHz, optimized at 3 GHz!

Features and Benefits

- Intermateable with standard 50 or 75 ohm BNC products
- Best material selection (brass, PTFE, BeCu, Gold) for outstanding performance and durability
- Better mechanical performance and durability with 1000 mating cycles guaranteed
- Field installable on most coaxial cables using hand-crimping tools
- Colored cable boots available for easy coding of video signals
- Custom made cable assemblies available

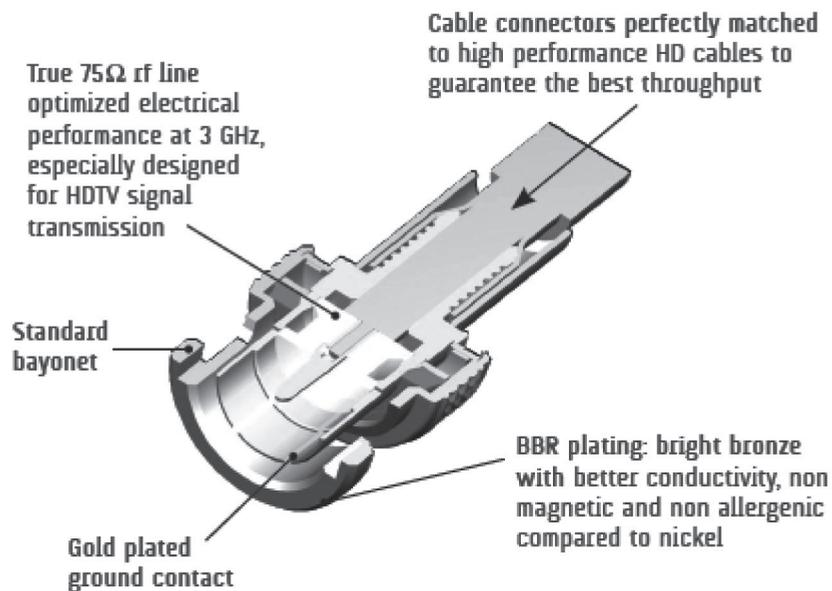

INTERFACE BNC 75 HDTV

JACK

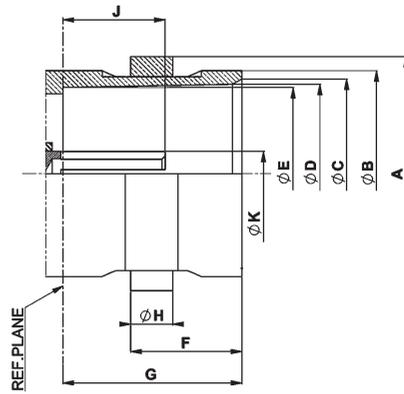

PLUG

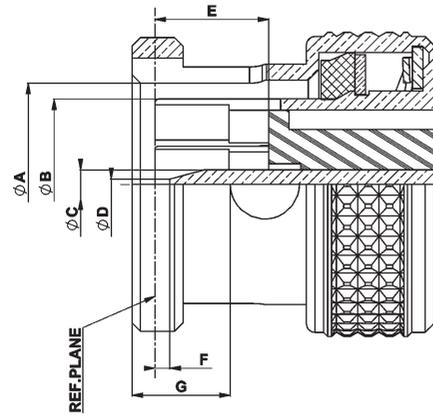

Letter	mm		inch	
	min.	max.	min.	max.
A	10.97	11.07	.432	.436
B	9.60	9.67	.378	.381
C	8.80	9.00	.346	.354
D	8.32	8.46	.328	.333
E	8.10	8.15	.319	.321
F	5.18	5.28	.204	.208
G	8.30	8.50	.327	.335
H	1.90	2.06	.075	.081
J	4.72	5.22	.186	.206
K	2.10	2.14	.083	.084

Letter	mm		inch	
	min.	max.	min.	max.
A	9.80	9.90	.386	.390
B	8.30	8.40	.327	.331
C	1.32	1.37	.052	.054
D	0.35	0.65	.014	.026
E	5.30	5.50	.209	.217
F	0.10	0.90	.004	.035
G	4.57	4.67	.180	.184

INTERFACE BNC 50Ω

JACK

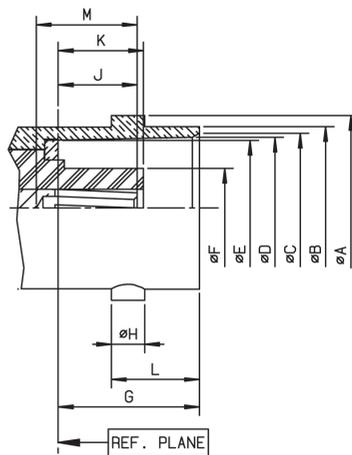

PLUG

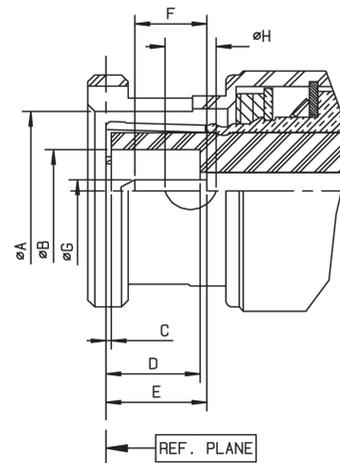

INTERFACE BNC 50Ω

Letter	mm		inch	
	min.	max.	min.	max.
A DIA	10.97	11.07	.432	.436
B DIA	9.60	9.70	.378	.382
C DIA	8.79	9.04	.346	.356
D DIA	8.31	8.46	.327	.333
E DIA	8.10	8.15	.319	.321
F DIA	-	4.72	-	.186
G	8.31	8.51	.327	.335
H	1.91	2.06	.075	.081
J	4.72	5.23	.186	.206
K	4.78	5.28	.188	.208
L	5.18	5.28	.204	.208
M	4.95	-	.195	-

Letter	mm		inch	
	min.	max.	min.	max.
A DIA	9.78	9.91	.385	.390
B DIA	4.83	-	.190	-
C	0.15	-	.006	-
D	5.28	5.79	.208	.228
E	5.33	5.84	.210	.230
F	1.98	-	.078	-
G DIA	1.32	1.37	.052	.054
H DIA	2.31	2.46	.091	.097

BNC 50Ω/BNC 75Ω

INTERFACE BNC 75Ω

JACK

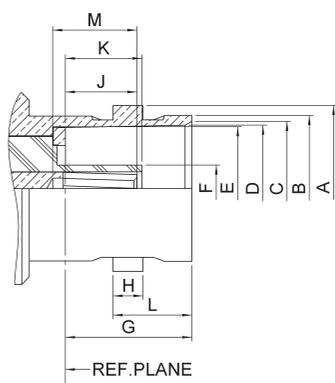

PLUG

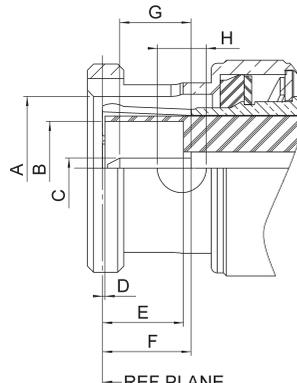

Letter	mm		inch	
	min.	max.	min.	max.
A DIA	10.97	11.07	.432	.436
B DIA	9.60	9.67	.378	.381
C DIA	8.80	9.00	.347	.354
D DIA	8.32	8.46	.328	.333
E DIA	8.10	8.15	.319	.321
F DIA	4.62	4.72	.182	.186
G	8.30	8.50	.326	.334
H	1.90	2.06	.074	.081
J	4.72	5.22	.186	.205
K	4.98	5.23	.196	.206
L	5.18	5.28	.204	.208
M	5.30	5.90	.209	.232

Letter	mm		inch	
	min.	max.	min.	max.
A DIA	9.80	9.90	.386	.389
B DIA	6.10	6.30	.240	.248
C DIA	1.32	1.37	.052	.054
D	0.05	-	.002	-
E	5.42	5.78	.213	.227
F	5.35	5.87	.211	.231
G	3.00	3.40	.118	.134
H DIA	3.15	3.35	.124	.132

CHARACTERISTICS

ELECTRICAL CHARACTERISTICS

Frequency range	DC - 6 GHz (optimized at 3 GHz)		
Impedance	75Ω		
V.S.W.R. (max)	DC - 1.5 GHz	1.5 - 3 GHz	3 - 6 GHz
Interface (plug + jack)	1.02	1.05	1.08
Mated pair	1.05	1.12	1.25
In series adapters	1.04	1.07	1.12
Working voltage	500 Vrms		
Dielectric withstanding voltage	1500 Vrms		
RF Leakage @ 1 GHz	75 dB		
RF Leakage @ 3 GHz	60 dB		
RF Leakage @ 6 GHz	50 dB		

MECHANICAL CHARACTERISTICS

Mating	Intermateable with 50Ω and 75Ω standard BNC connectors
Long life duration (mating endurance)	1000 cycles
Engagement force	13.6 N
Mating torque (bayonet)	28.5 N.cm
Coupling nut retention force	Axial force: 450 N Bending stress: 1000 N.cm
Center contact insertion force	10 N max
Vibration	MIL STD 202 Meth.204 cond B

ENVIRONMENTAL CHARACTERISTICS

Temperature range	-65°C + 165°C
Moisture resistance	MIL STD 202, Meth. 106 CECC 22000 paragraph 4.6.6
Corrosion resistance	MIL STD 202, Meth. 101 cond B (48 hours salt spray)

MATERIALS and PLATING

Components	Materials	Platings
Body	Brass	NPGR/BBR/Nickel
Center contact	Brass or Beryllium copper	NPGR
Outer contact	Brass	NPGR
Insulator	PTFE	
Gasket	Silicone Rubber	

CHARACTERISTICS

BNC 50Ω

Test/characteristics	Standard reference	Values/remarks		
ELECTRICAL CHARACTERISTICS				
Impedance		50Ω		
Frequency range		DC - 4 GHz		
Typical V.S.W.R. straight models cable groups: 2/50, 2.6/50, 5/50, 10 + 11/50, .141" right angle models: 2/50, 2.6/50, 5/50		1 GHz	2.5 GHz	4 GHz
		1.12	1.18 1.30 max	1.22
Insertion loss	straight connector right-angle connector	0.05	0.07	0.13
		0.08	0.16	0.20
RF leakage		-55 dB min from 2 to 3 GHz		
Insulation resistance		5000 MΩ min		
Contact resistance	center contact outer contact	MIL		
		1.5 mΩ 0.2 mΩ		
Working voltage in VRMS	at sea level (at 21 000m)	500 125		
		1500 375		
Dielectric withstanding voltage in VRMS	at sea level (at 21 000m)	1500 375		
RF testing voltage in VRMS	sea level (5 MHz)	1000		

MECHANICAL CHARACTERISTICS

Durability		500 matings
Force to engage and disengage	axial torque	13.6 N max 28.6 Ncm
		445 N
Coupling nut retention force		227 N
Cable retention force	cable 2/50, 2.6/50 cable 5/50, 10 + 11/50 cable .141"	27.2 N
Center contact retention force		27.2 N

ENVIRONMENTAL CHARACTERISTICS

Temperature range	flexible cables semi-rigid cables	-65°C + 165°C -65°C + 105°C
Thermo cycling test		MIL STD 202, method 107, condition B
Thermal shock		MIL STD 202, method 107, condition B
High temperature endurance		MIL STD 202, method 108
Corrosion salt spray		MIL STD 202, method 101, condition B
Vibration		MIL STD 202, method 204, condition B
Shock		MIL STD 202, method 213, condition G
Moisture resistance		MIL STD 202, method 106
Hermetic test		MIL STD 202, method 112, condition C vacuum 10 ⁻⁶ Hgmm (Torr) leakage rate < 10 ⁻⁶ atm/cm ² /s
Barometric pressure		Pressure test: 3.5 bars; duration: 2 mn; temperature: 15°C to 25°C

MATERIALS AND PLATING

	Materials	Platings
Bodies	Brass	Nickel / BBR
Center contact	male	Brass
	female	Bronze or heat treated beryllium following QQ-C-530
Nut	Brass	Gold
Insulator	PTFE	
Gasket	Silicon Rubber	

All dimensions are given in mm.

www.radiall.com

10-9

RADIALL
The next connection

CHARACTERISTICS

Test/characteristics	Standard reference	Values/remarks
----------------------	--------------------	----------------

ELECTRICAL CHARACTERISTICS

Impedance		75Ω
Frequency range		DC - 1.5 GHz
V.S.W.R. max straight models cable group: 2.6/75, 5/75, 6/75, 8/75, 10 + 11/75 right angle models: 2.6/75, 6/75		1.30 1.35
Insertion loss straight connector right-angle connector		0.2 dB max at 1 GHz 0.3 dB max at 1 GHz
RF leakage		-55 dB min from 2 to 3 GHz
Insulation resistance		5000 MΩ min
Contact resistance center contact outer contact	MIL	1.5 mΩ 0.2 mΩ
Working voltage in VRMS at sea level (at 21 000m)		500 125
Dielectric withstanding voltage in VRMS at sea level (at 21 000m)		1500 375
RF testing voltage in VRMS sea level (5 MHz)		1000

MECHANICAL CHARACTERISTICS

Durability		500 matings
Force to engage and disengage axial torque		13.6 N max 28.6 Ncm
Coupling nut retention force	MIL	445 N
Cable retention force cable 2.6/75, 5/75 6/75, 8/75, 10 + 11/75		340 N
Center contact retention force		27 N

ENVIRONMENTAL CHARACTERISTICS

Temperature range flexible cables		-65°C + 165°C
Thermo cycling test		MIL STD 202, method 107, condition B
High temperature endurance		MIL STD 202, method 108
Corrosion salt spray		MIL STD 202, method 101, condition B
Vibration		MIL STD 202, method 204, condition B
Shock		MIL STD 202, method 213, condition G
Moisture resistance		MIL STD 202, method 106
Hermetic test		MIL STD 202, method 112, condition C vacuum 10 ⁻⁶ Hgmm (Torr) leakage rate < 10 ⁻⁶ atm/cm ³ /s
Barometric pressure		Pressure test: 3.5 bars; duration: 2 mn; temperature: 15°C to 25°C

MATERIALS AND PLATING

	Materials	Platings
Bodies	Brass	Nickel
Center contact male female	Brass Bronze or heat treated beryllium following QQ-C-530	Gold
Nut	Brass	
Insulator	PTFE	
Gasket	Silicone Rubber	

Standard packaging = 100 pieces.

COMMERCIAL VERSION R141 XXX 161 and R142 XXX 161

ELECTRICAL CHARACTERISTICS

	R141 XXX 161	R142 XXX 161
Impedance	50Ω	75Ω
Operating frequency	DC to 1.5 GHz	
Typical V.S.W.R. (1.5 GHz)		
straight models	∅ 2.6	1.21
	∅ 5	1.14
	∅ 6	1.05
right angle models	∅ 5 & ∅ 6	1.17
Testing voltage (VRMS)	1500	
Operating voltage (VRMS)	500	
Insulation resistance (MΩ)	5000	
Contact resistance (mΩ)	10	

MECHANICAL CHARACTERISTICS

Durability	100 matings
------------	-------------

ENVIRONMENTAL CHARACTERISTICS

Temperature range	-40°C + 85°C
-------------------	--------------

MATERIALS AND PLATING

	Materials	Platings
Male and female bodies	Brass	Nickel
Coupling nut	Die cast zinc	
Outer contact	Brass	
Insulators	Polypropylene	
Male and female center contacts	Brass	Gold

ECO VERSION R141A XXX XXX and R142A XXX XXX

ELECTRICAL CHARACTERISTICS

	R141A XXX XXX	R142A XXX XXX
Impedance	50Ω	75Ω
Frequency range	DC - 1 GHz	
Typical V.S.W.R. (straight models)	1.3 at 1 GHz	
Temperature range	-40°C / +85°C	
Durability	100 mating cycles	

MATERIALS AND PLATING

	Materials	Platings
Connector body	Brass/Die cast zinc	Nickel
Insulators	PTFE/Polypropylene	
Female center contacts	Phosphor bronze	Gold 0.1µm typical (Center contact)

PACKAGING/MOQ

Packaging/MOQ	100 pieces bulk/MOQ 1000 pieces Unit packaging/MOQ 100 pieces
---------------	--

Standard packaging = 100 pieces.

All dimensions are given in mm.

FINDER GUIDE

CABLE CONNECTORS



Model	Straight plug		Right-angle plug		Straight jack		Square flange straight jack		Bulkhead straight jack	
	Crimp and full crimp	Clamp	Crimp and full crimp	Clamp	Crimp and full crimp	Clamp	Crimp and full crimp	Clamp	Crimp and full crimp	Clamp
2/50/S (RG178)	R141 070 520	R141 003 000						R141 253 000	R141 301 000	R141 323 000
2.6/50/S (RG316)	R141 075 000 R141 075 161 R141A 075 161	R141 004 000	R141 181 161	R141 154 000	R141 217 000			R141 254 000 R141 277 000 R141 278 000	R141 306 000 R141 306 503 R141 331 500 R141A 306 000 R141 331 500	R141 304 000 R141 324 000 R141 324 200
2.6/50/D (RD316)		R141 004 000		R141 154 000				R141 254 000 R141 277 000 R141 278 000		
2.6/75/S (RG179)	R142 076 000 R142 076 161 R142A 076 161	R142 004 000		R142 154 000	R142 217 000			R142 202 000	R142 306 500 R142 306 503 R142 331 011 R142A 306 500	
3.6/75/D (BT3002)	R142A 081 130								R142A 325 106	
5/50/S (RG58)	R141 072 000 R141 082 000 R141 082 161 R141A 082 161	R141 007 161 R141 008 000 R141 009 000 R141 010 000	R141 182 000 R141 182 161 R141 182 177	R141 156 000	R141 237 000 R141 237 161	R141 207 000	R141 292 000	R141 256 000 R141 258 000	R141 308 000 R141 332 161 R141 332 500 R141A 332 161	R141 327 000
5/50/D (RG142)	R141 083 000 R141 097 000 R141A 083 000	R141 008 000 R141 009 000 R141 010 000	R141 183 000	R141 156 000	R141 220 000	R141 207 000	R141 297 000	R141 258 000		R141 327 000
5/75/D	R142 083 000									
6/75/S (RG59)	R142 085 000 R142 085 161 R142 085 165 R142A 085 161	R142 016 000 R142 016 161	R142 184 000 R142 184 161	R142 157 000	R142 242 000 R142 242 161			R142 268 000	R142 334 161 R142A 334 161	R142 329 000
8.07/50	R141 097 190						R141 296 190			
8/75/S		R142 017 000								
10 + 11/50		R142 018 000								
10 + 11/75	R141 095 000	R142 018 000								
141" (RG402)		R141 052 000								R141 338 007

CAPS

Model	Free	Cord	Chain	Short-circuit chain
Male	R141 802 000	R141 805 000	R141 812 000	R141 862 000
Female			R141 842 000	

RECEPTACLES

Model	Straight female flange		Right-angle female flange	Straight female bulkhead		Straight male flange	Straight male bulkhead	Press mount receptacles	PCB receptacles		
	Square	2 hole	Square	Front mount	Right angle	Square	Front mount	Straight	Straight	Right angle	Bulkhead right angle
Solder contact with Solder pot	R141 403 000 R141 404 000 R141 406 000 R141 407 000 R141 410 000 R142 412 000	R141 453 000	R141 653 000 R141 654 000	R141 554 000 R141 554 161 R141 557 000 R141 559 000 R141 563 161 R141 572 000 R141 574 000 R141 574 161 R141 603 000 R141 605 000 R141 625 000 R142 562 000 R141A 605 000	R141 680 000	R141 440 000	R141 580 000 R142 580 000				
Solder cylindrical contact								R141 500 200			
Solder pins (standard space)									R141 426 000 R141 426 161 R142 426 020 R142 426 261	R141 665 000 R141 665 200	R141A 676 121
Solder pins (reduced space)									R141 508 200 R142 500 230		
Press fit pins											R141 684 130 R142 676 430 R142 684 130

IN-SERIES ADAPTERS

Model	Straight	Straight bulkhead	Straight flange	Right-angle	Tree	Cross
M-M	R141 703 000 R142 703 000					
F-F	R141 704 000 R142 704 000	R141 720 000 R141 723 000 R141 723 161 R142 730 000 R141 753 000 R142 720 000 R142 723 000 R141A 720 000 R142A 720 000	R141 710 000 R141 717 000 R142 710 000			
M-F				R141 770 000 R142 770 000		
F-F / M					R141 780 000 R141 789 000 R142 780 000 R142 789 000	
F-F / F					R141 782 000 R142 782 000	
M-F-F / F						R141 799 000

PLUGS AND JACKS

STRAIGHT PLUGS CRIMP TYPE FOR FLEXIBLE CABLES

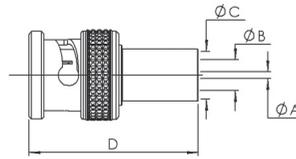

Cable group	Cable group dia.	Part number	Dimensions mm (inch)				Packaging	Note
			A	B	C	D		
Belden 1855A, Draka 0.6/2.8 AF, CAE HD 0628	0.6/2.8	R142 077 702	0.85 (.03)	2.85 (.11)	5.42 (.21)	27.68 (1.09)	100	
Argosy Image 360	0.6/2.95	R142 077 712		3.00 (.12)				
Belden 1505A, Draka 0.8/3.7 AF, CAE HD 08370, Argosy Image 720	0.8/3.7	R142 077 722	3.75 (.15)	6.60 (.26)	26.68 (1.05)	Hexagonal crimp tool 1.73/6.48		
		R142 085 702	0.90	3.95	6.60	28.68		
Belden 1694A, Draka 1.0/4.8 AF, CAE HD 10460, Argosy Image 1000	1.0/4.8	R142 077 732	1.05 (.04)	4.85 (.19)	7.50 (.30)	26.68 (1.05)		
Belden 7731, Draka 1.6/7.3 AF, CAE HD16720, Argosy Image 2000	1.6/7.3	R142 077 747	1.70	7.45	11.05	32		

RIGHT ANGLE PLUG CRIMP TYPE FOR FLEXIBLE CABLE

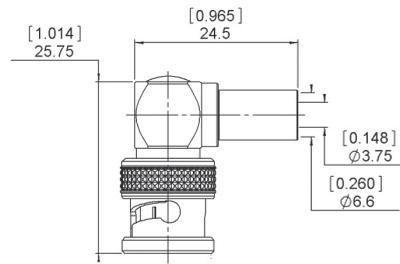

Cable group	Cable group dia.	Part number	Packaging
Belden 1505A, Draka 0.8/3.7 AF, CAE HD 08370, Argosy Image 720	0.8/3.7	R142 187 720	100

STRAIGHT BULKHEAD JACK CRIMP TYPE FOR FLEXIBLE CABLE

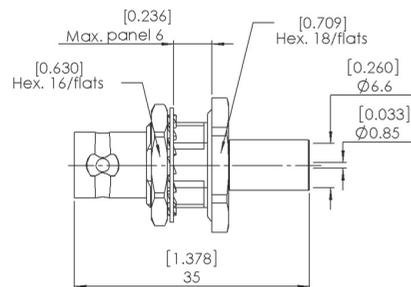

Cable group	Cable group dia.	Part number	Panel drilling	Packaging
Belden 1505A, Draka 0.8/3.7 AF, CAE HD 08370, Argosy Image 720	0.8/3.7	R142 334 700	P20	100

PCB FEMALE RECEPTACLES

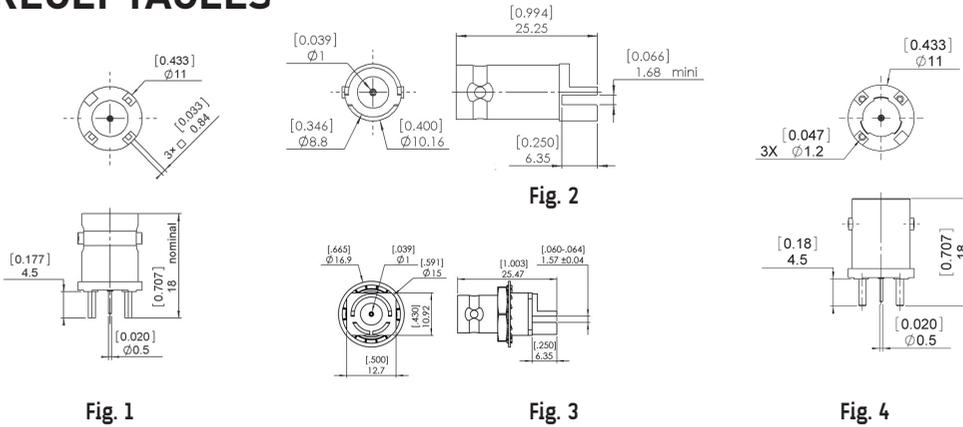

Part number	Fig.	Captive center contact	Panel drilling	Packaging	Note
R142 500 730	1	yes	P28	100	Straight PCB
R142 568 703	2			100	Edge mount PCB
R142 567 703	3				Bulkhead Edge mount PCB
R142 500 740	4		P27	60	Straight PCB, Zamak

RIGHT ANGLE PCB FEMALE RECEPTACLES

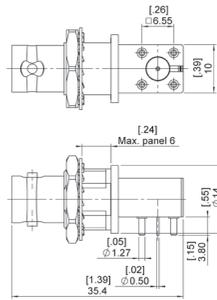

Part number	Captive center contact	Note
R142 676 700	yes	Bulkhead

IN SERIES ADAPTERS

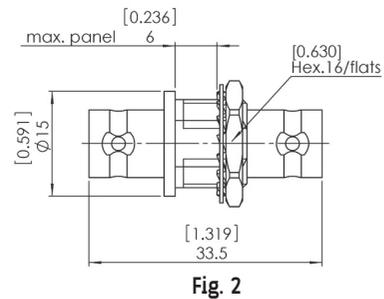
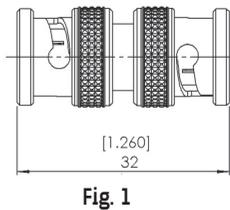

Part number	Fig.	Captive center contact	Panel drilling	Note	Packaging
R142 703 703	1	yes	P20	Male-male	100
R142 720 700	2			Female-female	

BETWEEN SERIES ADAPTERS

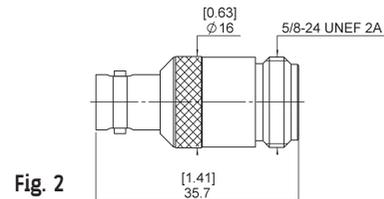
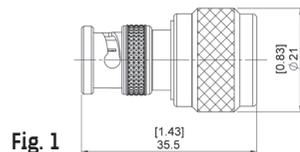

Part number	Fig.	Captive center contact	Note
R192 417 010	1	yes	BNC HD male - N male
R192 418 010	2		BNC HD female - N female

To download data sheets and assembly instructions, visit www.radiall.com & enter the part number in the Search box. **Bold** part numbers represent products typically in stock & available for immediate shipment. See page 8 and 9 for packaging information.

STRAIGHT PLUGS

STRAIGHT PLUGS CLAMP TYPE

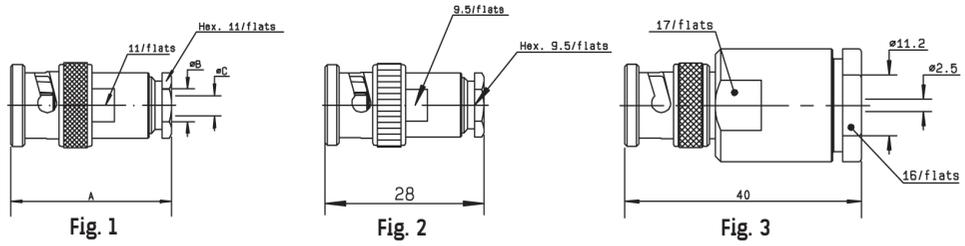

Cable group	Cable group dia.	Part number	Fig.	Dimensions (mm)			Captive center contact	Note
				A	B	C		
RG178/RG196	2/50/S + D	R141 003 000	1	27	2.2	0.6	yes	
RG174/RG316/RD316	2.6/50/S + D	R141 004 000			3.1			
RG58/RG141	5/50/S	R141 007 161	2				no	Commercial version
RG58/RG141/RG142/RG223/RG400	5/50/S + D	R141 008 000	1	28	5.6	1.2	no	
		R141 009 000	1	28	5.6	1.2	no	
		R141 010 000				1.05	yes	
RG213/RG393/RG214/RG216	10 + 11/50/S + D	R141 018 000	3					
RG402	.141"	R141 052 000	1	29	3.65	1.2	no	Semi-rigid cable

STRAIGHT PLUGS FULL CRIMP TYPE FOR FLEXIBLE CABLES

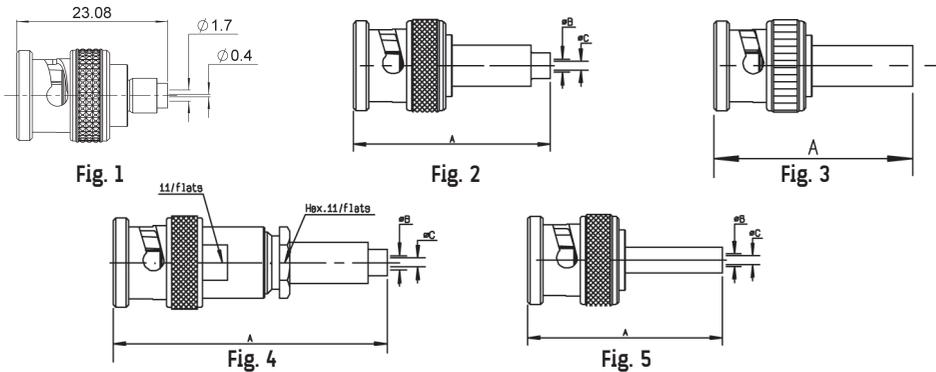

Cable group	Cable group dia.	Part number	Fig.	Dimensions (mm)			Captive center contact	Note
				A	B	C		
RG178/RG196	2/50/S	R141 070 520	1	23	1.7	0.4	yes	Reverse crimp
RG174/RG316	2.6/50/S	R141 075 000	2	31	1.8	0.6	yes	Commercial version
		R141 075 161	3	30.3				
		R141A 075 161	3	26	1.7	0.6	yes	Not full crimp/ Single piece body ECO version
RG58/RG14	5/50/S	R141 095 020	4	43	2.6	1.05	yes	
		R141 082 000	4	39	3.1	yes	Single piece body Commercial version	
		R141 082 161	5	28				
		R141A 082 161	3	30				3.1
		RG142/RG223/RG400	5/50/D	R141 083 000	5	28	3	1.05
R141A 083 000	2			30	3.1	1.2	no	ECO version
R141 097 000	4			43	3	1.05	yes	
	8.07/50	R141 097 190	4	50	6.3	2.5	yes	

For other types of cables (75Ω, 93Ω or BT cables), please see "additional connectors" on page 10-32.
 To download data sheets and assembly instructions, visit www.radiall.com & enter the part number in the Search box.
Bold part numbers represent products typically in stock & available for immediate shipment.
 See page 8 and 9 for packaging information.

RIGHT ANGLE PLUGS AND STRAIGHT JACKS

BNC 50Ω

RIGHT ANGLE PLUGS CLAMP TYPE FOR FLEXIBLE CABLES

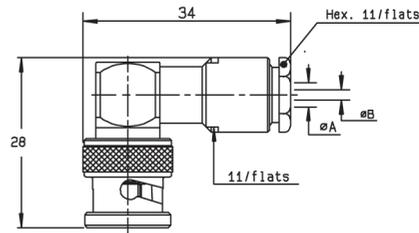

Fig. 1

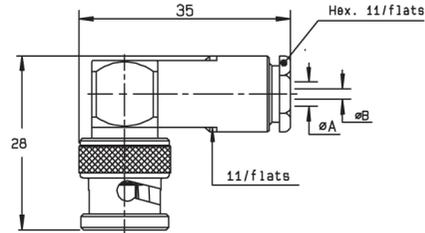

Fig. 2

Cable group	Cable group dia.	Part number	Fig.	Dimensions (mm)		Captive center contact	Note
				A	B		
RG174/RG316/RD316	2.6/50/S + D	R141 154 000	1	3.1	0.6	yes	100 pieces
RG58/RG141/RG142/RG223/RG400	5/50/S + D	R141 156 000	2	5.6	1.05		Unit packaging

RIGHT ANGLE PLUGS FULL CRIMP TYPE FOR FLEXIBLE CABLES

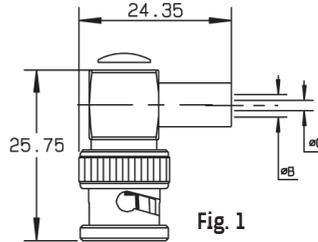

Fig. 1

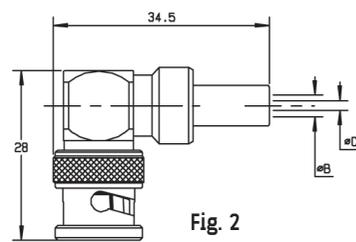

Fig. 2

Cable group	Cable group dia.	Part number	Fig.	Dimensions (mm)		Captive center contact	Note
				B	C		
RG174/RG316	2.6/50/S	R141 181 161	1	3.25	1.7	yes	Commercial version
RG58/RG141	5/50/S	R141 182 000	2	5.5	1.05		Single piece body
		R141 182 161	1	5.5	3.15		Commercial version
		R141 182 177	2	5.55	3.2		Non magnetic
RG142/RG223/RG400	5/50/D	R141 183 000	2	5.8	1.05	Single piece body	

STRAIGHT JACKS FOR FLEXIBLE CABLES

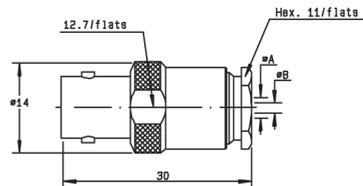

Fig. 1

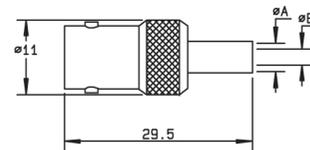

Fig. 2

Cable group	Cable group dia.	Part number	Fig.	Dimensions (mm)		Captive center contact	Note
				A	B		
RG58/RG141/RG142/RG223/RG400	5/50/S + D	R141 207 000	1	5.6	1.05	no	Clamp type
RG174/RG316	2.6/50/S	R141 217 000	2		0.57	yes	Full crimp type
RG58/RG141	5/50/S	R141 237 000	2	5.5	1.05	yes	Single piece body, full crimp type
		R141 237 161	2				Commercial version, full crimp type
RG142/RG223/RG400	5/50/D	R141 220 000	2				

For other types of cables (75Ω, 93Ω or BT cables), please see "additional connectors" on page 10-32.
 To download data sheets and assembly instructions, visit www.radiall.com & enter the part number in the Search box.
Bold part numbers represent products typically in stock & available for immediate shipment.
 See page 8 and 9 for packaging information.

SQUARE FLANGE JACKS

STRAIGHT SQUARE FLANGE JACKS CLAMP TYPE FOR FLEXIBLE CABLES

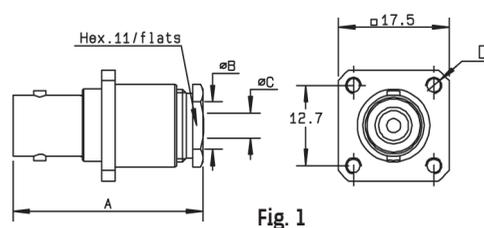
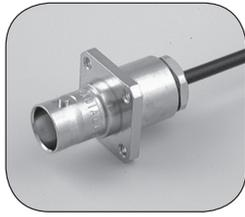

Fig. 1

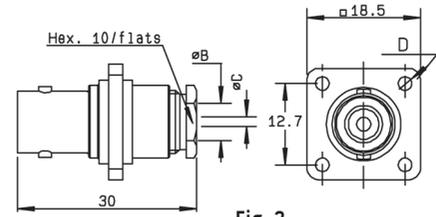

Fig. 2

Cable group	Cable group dia.	Part number	Fig.	Dimensions (mm)				Captive center contact	Panel drilling	Note
				A	B	C	D			
RG178/RG196	2/50/S + D	R141 253 000	1	29.5	2.2	0.6	3-56-UNF-2B	yes	P01	
		R141 254 000			3.1					
RG174/RG316/RD316	2.6/50/S + D	R141 278 000	2		3			no	P02	
		R141 277 000			2.6				P01	Insulated flange
RG58/RG141	5/50/S	R141 256 000	2		5.6	1.05	2.6		P02	Insulated flange
RG58/RG141/RG142/RG223/RG400	5/50/S + D	R141 258 000	1	30	5.6	1.05	3-56-UNF-2B		P02	Unit packaging

STRAIGHT SQUARE FLANGE JACKS FULL CRIMP TYPE FOR FLEXIBLE CABLES

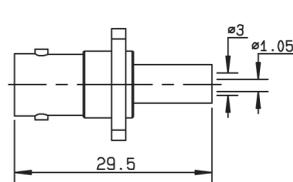

Fig. 1

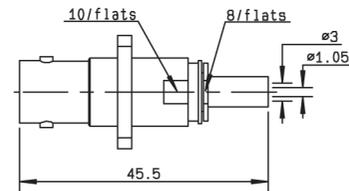

Fig. 2

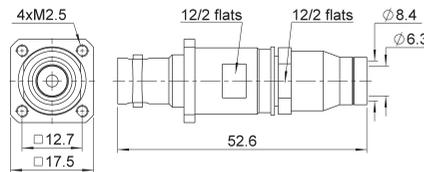

Fig. 3

Cable group	Cable group dia.	Part number	Fig.	Dimensions D (mm)	Captive center contact	Panel drilling	Note
RG58/RG141	5/50/S	R141 292 000	1	3 x 56 UNEF 2B	yes	P23	Single piece body
RG142/RG223/RG400	5/50/D	R141 297 000	2	M2.5 x 0.45			
	8.07/50	R141 296 190	3	M2.5 x 0.45		P13	

For other types of cables (75Ω, 93Ω or BT cables), please see "additional connectors" on page 10-32.

To download data sheets and assembly instructions, visit www.radiall.com & enter the part number in the Search box.

Bold part numbers represent products typically in stock & available for immediate shipment.

See page 8 and 9 for packaging information.

STRAIGHT BULKHEAD JACKS CLAMP TYPE

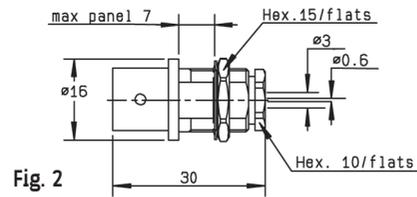
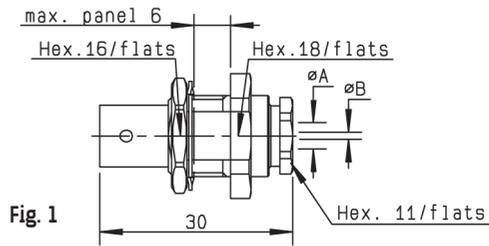

Cable group	Cable group dia.	Part number	Fig.	Dimensions (mm)		Captive center contact	Panel drilling	Note
				A	B			
RG178/RG196	2/50/S	R141 323 000	1	2.2	0.6	yes	P14	Panel sealed
RG174/RG316	2.6/50/S	R141 304 000	2					Totally sealed
		R141 324 000	1	3.1	0.6	yes		Panel sealed
RG174/RG316/RD316	2.6/50/S + D	R141 324 200	1	3.1	0.6	yes		Panel sealed
RG58/RG141/RG142/RG223/RG400	5/50/S + D	R141 327 000	1	5.6	1.05	no		Panel sealed
RG401	.141"	R141 338 007	1	3.68	1.27	yes		Panel sealed, non magnetic

STRAIGHT BULKHEAD JACKS CRIMP TYPE FOR FLEXIBLE CABLES

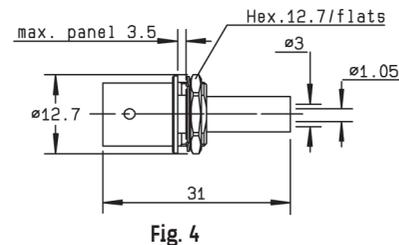
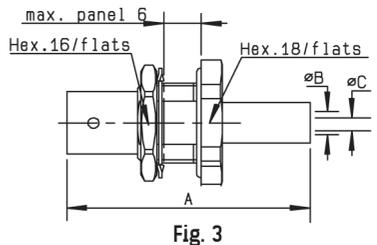
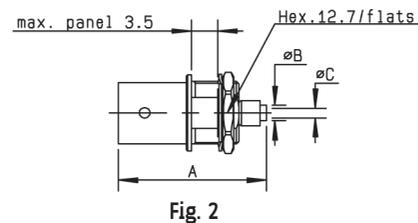
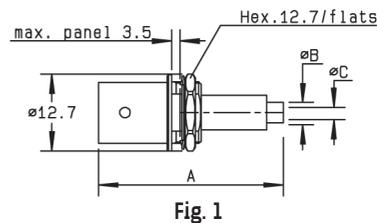

Cable group	Cable group dia.	Part number	Fig.	Dimensions (mm)			Captive center contact	Panel drilling	Note
				A	B	C			
RG174/RG316	2.6/50/S	R141 306 000	1	34	1.7	0.6	yes	P18	
		R141 306 503	2	26	2.95				Reverse crimping/commercial version
		R141 331 500	3	38.5	1.7		P14 or P20	Panel sealed	
		R141A 306 000	1	31	1.7	0.6	no	P18	ECO version
		R141A 331 500	3	34	1.6	0.7	no	P14	Panel sealed ECO version
RG58/RG141	5/50/S	R141A 332 161	3	34	3.1	1.2	no		Panel sealed ECO version
		R141 308 000	4					P18	Single piece body
		R141 332 161	3	35.5	3.1	1.05	yes	P14 or P20	Panel sealed/commercial version
		R141 332 500							Panel sealed Reverse crimping/single piece body

For other types of cables (75Ω, 93Ω or BT cables), please see "additional connectors" on page 10-32.

To download data sheets and assembly instructions, visit www.radiall.com & enter the part number in the Search box.

Bold part numbers represent products typically in stock & available for immediate shipment.

See page 8 and 9 for packaging information.

FLANGE RECEPTACLES

FLANGE RECEPTACLES

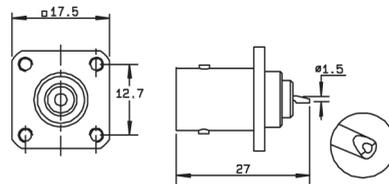

Fig. 1

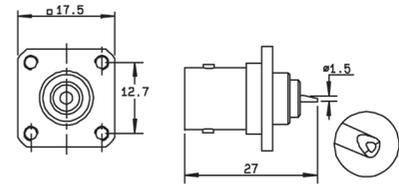

Fig. 2

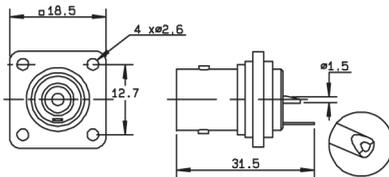

Fig. 3

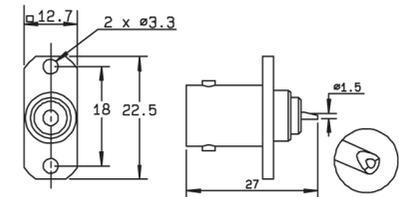

Fig. 4

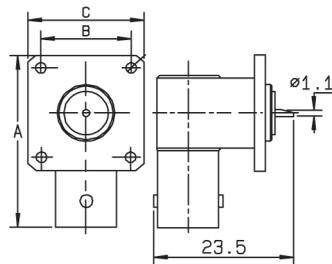
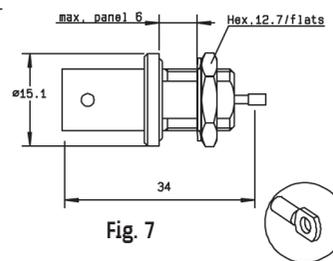
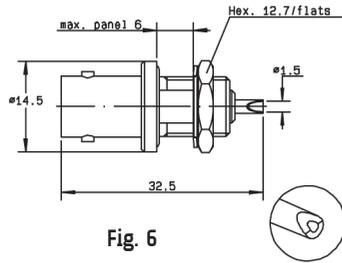
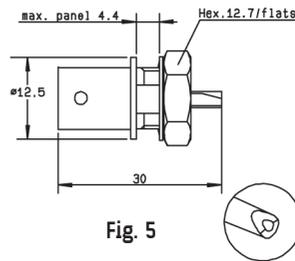
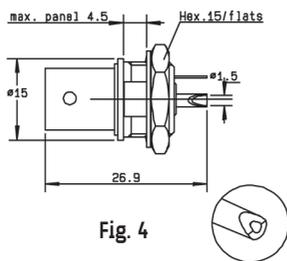
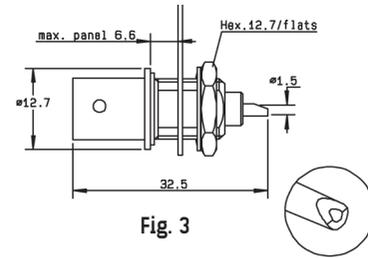
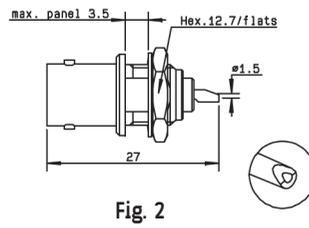
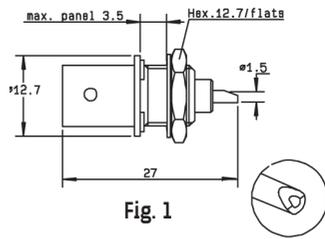

Fig. 5

Part number	Fig.	Dimensions (mm)			Captive center contact	Panel drilling	Flange holes	Note
		A	B	C				
R141 403 000	1				yes	P08	4 x M2.5	
R141 404 000	2					P07	4 x M2.5	
R141 406 000	1					P08	4 x M2.6	
R141 407 000	2					P07		
R141 410 000	3					P02		Insulated flange/solder tag
R141 453 000	4					P24		2 hole flange
R141 653 000	5	27.6	13.5	19		P05	4 x M3.3	Right angle receptacle
R141 654 000		26.9	12.7	17.5		P06	4 x M2.6	Right angle receptacle

STRAIGHT BULKHEAD RECEPTACLES WITH SOLDER POT



Part number	Fig.	A (Length)	Captive center contact	Panel drilling	Note
R141 554 000	1		yes	P16	
R141 557 000	2				
R141 559 000	3			P18	Solder tag
R141 563 161	2				Silver plated center contact/ commercial version
R141 572 000	4			P14	Insulated receptacle + solder tag
R141 574 000	5			P18	Commercial version/insulated
R141 574 161					Fully sealed/Q200-5 insulator
R141 603 000	6			P19	Fully sealed
R141 605 000					Not sealed/ECO version
R141A 605 000	3	28			P29
R141 625 000	7			P18	

RIGHT ANGLE BULKHEAD RECEPTACLE WITH SOLDER POT

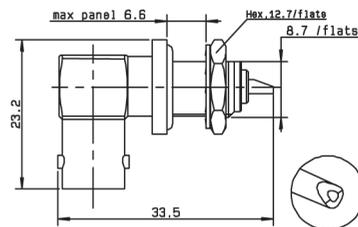

Part number	Captive center contact	Panel drilling
R141 680 000	yes	P18

To download data sheets and assembly instructions, visit www.radiall.com & enter the part number in the Search box. **Bold** part numbers represent products typically in stock & available for immediate shipment. See page 8 and 9 for packaging information.

RECEPTACLES

RECEPTACLES

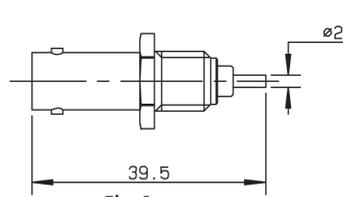

Fig. 1

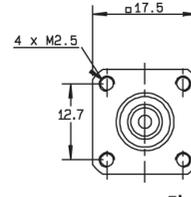

Fig. 2

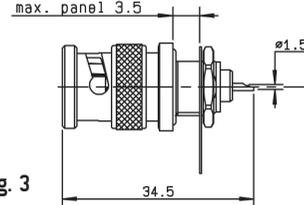
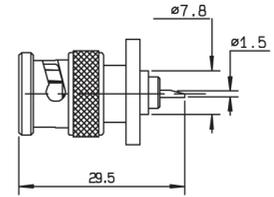

Fig. 3

Part number	Fig.	Captive center contact	Panel drilling	Note
R141 561 161	1		P22	Screw on receptacle
R141 440 000	2	yes	P03	Male square flange
R141 580 000	3		P18	Male bulkhead / Panel sealed / Solder tag

STRAIGHT PCB FEMALE RECEPTACLES

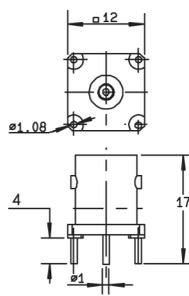

Fig. 1

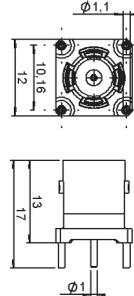

Fig. 2

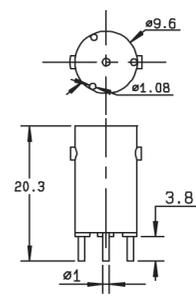

Fig. 3

Part number	Fig.	Captive center contact	Panel drilling	Note
R141 426 000	1			
R141 426 161	2	yes	P09	Die cast body / commercial version
R141 508 200	3		P21	

RIGHT ANGLE PCB FEMALE RECEPTACLES

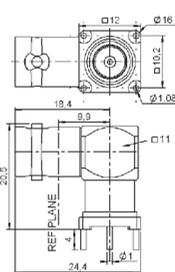

Fig. 1

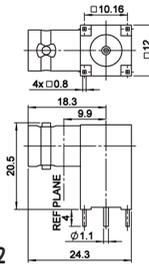

Fig. 2

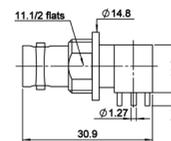

Fig. 3

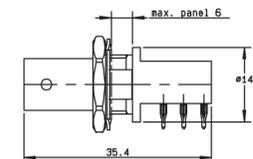

Fig. 4

Part number	Fig.	Captive center contact	Panel drilling	Finish	Note
R141 665 000	1		P25		
R141 665 200	2		P09		
R141A 676 121	3	yes	P26 and P30	Nickel	Rear mount / ECO version
R141 684 130	4		P11 and P20		Packaging 10 / press-fit pins

IN SERIES ADAPTERS

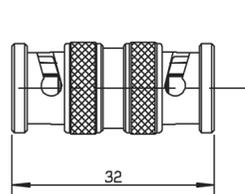

Fig. 1

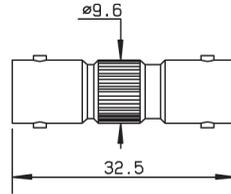

Fig. 2

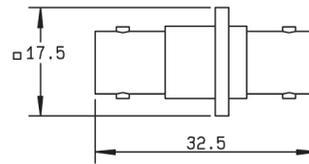

Fig. 3

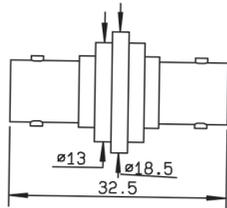

Fig. 4

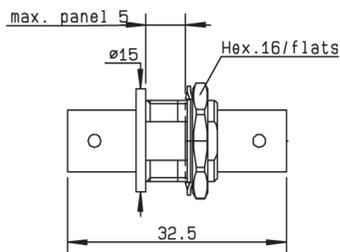

Fig. 5

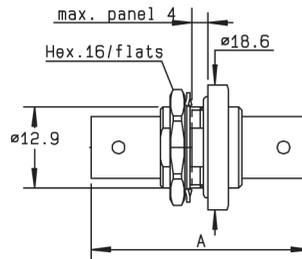

Fig. 6

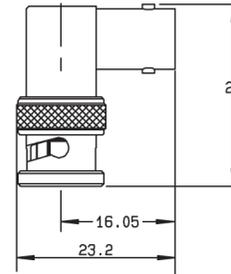

Fig. 7

Part number	Fig.	Captive center contact	Dimension A (mm)	Flange holes	Panel drilling	Note	
R141 703 000	1	yes				Male - male	
R141 704 000	2					Female - female	
R141 710 000	3				4 x M2.5	P13	Female - female square flange
R141 717 000	4				4 x 2.6	P02	Female - female square insulated flange
R141 720 000	5					P17	Female - female bulkhead
R141A 720 000							Female - female bulkhead/ECO version
R141 723 000						P17 or P20	Female - female insulated bulkhead
R141 723 161							Female - female insulated bulkhead/commercial version
R141 730 000	6			35.7		P17	Female - female panel sealed bulkhead
R141 753 000				35.3			Female - female hermetically sealed bulkhead
R141 770 000	7					Male - female right angle	

To download data sheets and assembly instructions, visit www.radiall.com & enter the part number in the Search box. **Bold** part numbers represent products typically in stock & available for immediate shipment. See page 8 and 9 for packaging information.

ADAPTERS AND CAPS

CROSS AND TEE IN SERIES ADAPTERS

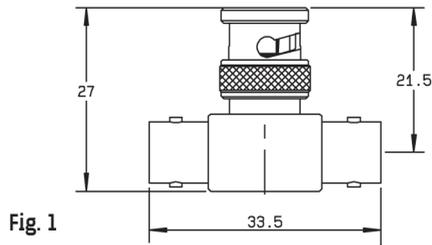

Fig. 1

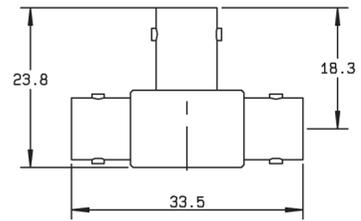

Fig. 2

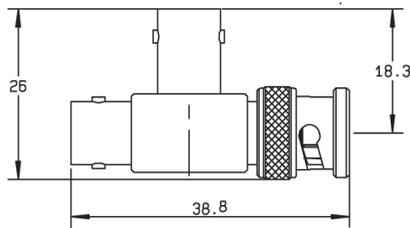

Fig. 3

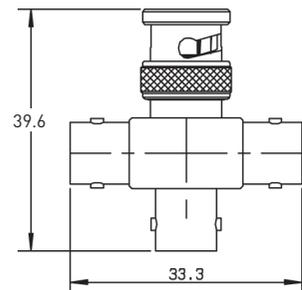

Fig. 4

Part number	Fig.	Captive center contact	Note
R141 780 000	1	yes	Male/female-female tee
R141 782 000	2		Female/female-female tee
R141 789 000	3		Female/female-male tee
R141 799 000	4		Male/female-female-female cross/unit packaging

MALE AND FEMALE CAPS

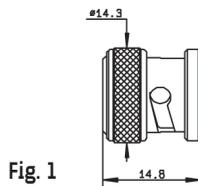

Fig. 1

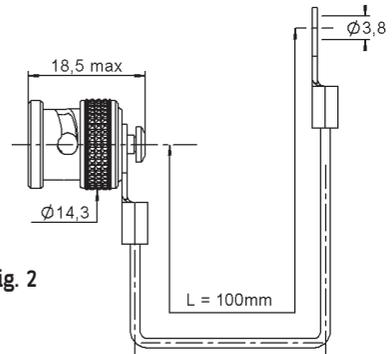

Fig. 2

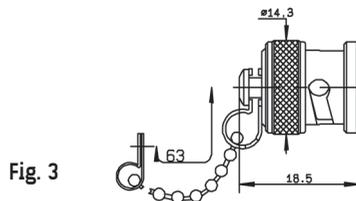

Fig. 3

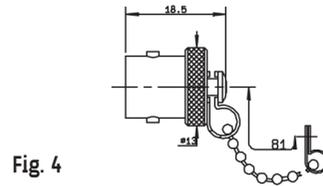

Fig. 4

Part number	Fig.	Note
R141 802 000	1	Male
R141 805 000	2	Male with cord
R141 812 000	3	Male with chain
R141 842 000	4	Female with chain
R141 862 000	3	Male short circuit/with chain

STRAIGHT PLUGS CLAMP TYPE FOR FLEXIBLE CABLES

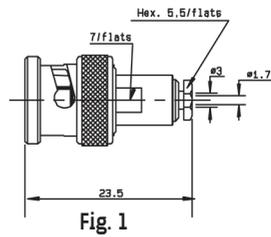

Fig. 1

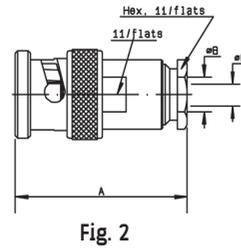

Fig. 2

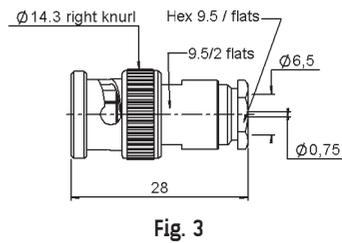

Fig. 3

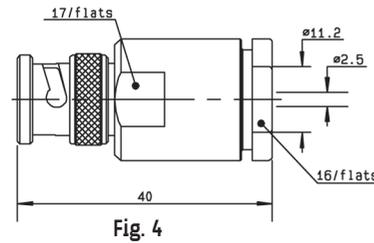

Fig. 4

Cable group	Cable group dia.	Part number	Fig.	Dimensions (mm)			Captive center contact	Note
				A	B	C		
RG179	2.6/75/S	R142 004 000	1				yes	
RG59/RG62	6/75/S	R142 016 000	2	28	6.6	0.75	yes	Unit packaging
		R142 016 161	3					Commercial version
RG6A/U	8/75/S + D	R142 017 000	2	45.5	9.1	1.5	yes	Unit packaging
RG216/RG11/RG12/RG144	10 + 11/75/S + D	R142 018 000	4					

STRAIGHT PLUGS FULL CRIMP TYPE FOR FLEXIBLE CABLES

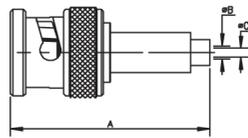

Fig. 1

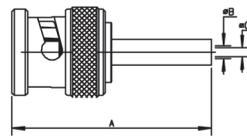

Fig. 2

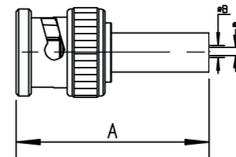

Fig. 3

Cable group	Cable group dia.	Part number	Fig.	Dimensions (mm)			Captive center contact	Note
				A	B	C		
RG179	2.6/75/S	R142 076 000	1				yes	
		R142 076 161	3	31	1.8	0.4	yes	Commercial version
		R142A 076 161	3	25.3	1.65	0.4	no	Single piece body/ECO version
BT3002	3.6/75/D	R142 081 120	2	29	2.1	0.34		Single piece body
		R142A 081 130	2	29	2.1	0.34		Single piece body/ECO version
	3.8/93/S	R142 078 161	3	30	3.85	0.6		Commercial version
BT2002	5/75/D	R142 083 000	2	27.3	5.5		yes	Single piece body
RG59/RG62	6/75/S	R142 085 000	2	28	6.6	0.75		Single piece body
		R142 085 161	3	28	3.9			Single piece body/Commercial version
		R142A 085 161	3	29	4	0.8	no	Single piece body/ECO version
	7/75/S	R142 086 161	3	30.8	5.15	1.35		Single piece body/Commercial version
	7.5/75/D	R142 090 000	2	28	5.25	0.85	yes	Single piece body
RG11/RG12/RG144	10/75/S	R142 095 000	2	28	11.05	1.35	yes	Single piece body

For others types of cables (75Ω, 93Ω or BT cables), please see "additional connectors" on page 10-32.

To download data sheets and assembly instructions, visit www.radiall.com & enter the part number in the Search box.

Bold part numbers represent products typically in stock & available for immediate shipment.

See page 8 and 9 for packaging information.

RIGHT ANGLE PLUGS AND JACKS

RIGHT ANGLE PLUGS CLAMP TYPE FOR FLEXIBLE CABLES

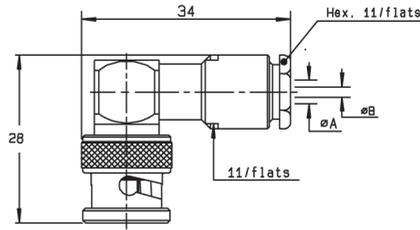

Fig. 1

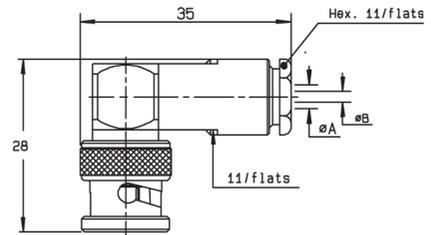

Fig. 2

Cable group	Cable group dia.	Part number	Fig.	Dimensions (mm)		Captive center contact
				A	B	
RG179	2.6/75/S	R142 154 000	1	3.1	0.6	yes
RG59/RG62	6/75/S	R142 157 000	2	6.6	0.75	

RIGHT ANGLE PLUGS FULL CRIMP TYPE FOR FLEXIBLE CABLES

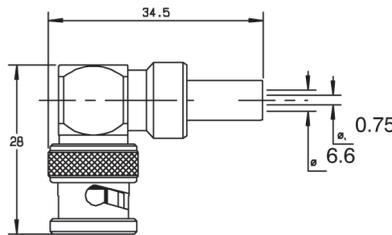

Fig. 1

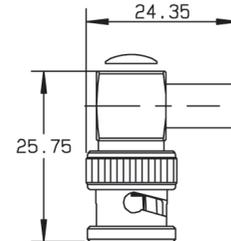
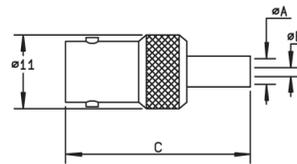

Fig. 2

Cable group	Cable group dia.	Part number	Fig.	Captive center contact	Note
RG59/RG62	6/75/S	R142 184 000	1	yes	
		R142 184 161	2		Commercial version

STRAIGHT JACKS FULL CRIMP TYPE FOR FLEXIBLE CABLES



Cable group	Cable group dia.	Part number	Dimensions (mm)			Captive center contact	Note
			A	B	C		
RG179	2.6/75/S	R142 217 000	1.75	0.4	32.5	yes	
RG59/RG62	6/75/S	R142 242 000	6.6	0.75	29.5		Single piece body
		R142 242 161			29	Single piece body/commercial version	

For others types of cables (75Ω, 93Ω or BT cables), please see "additional connectors" on page 10-32.
 To download data sheets and assembly instructions, visit www.radiall.com & enter the part number in the Search box.
Bold part numbers represent products typically in stock & available for immediate shipment.
 See page 8 and 9 for packaging information.

STRAIGHT SQUARE FLANGE JACKS CLAMP TYPE FOR FLEXIBLE CABLES

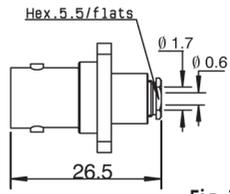

Fig. 1

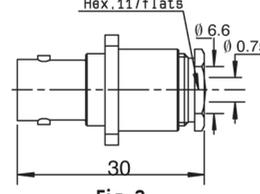
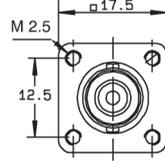
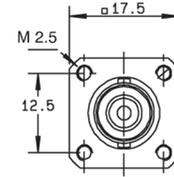
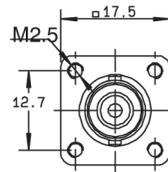
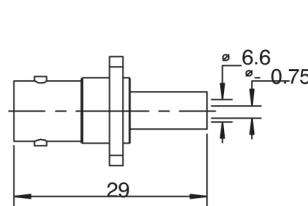

Fig. 2



Cable group	Cable group dia.	Part number	Fig.	Captive center contact	Panel drilling	Note
RG179	2.6/75/S	R142 202 000	1	yes	P01	Unit packaging
RG59/RG62	6/75/S	R142 268 000	2			

STRAIGHT SQUARE FLANGE JACK FULL CRIMP TYPE FOR FLEXIBLE CABLES



Cable group	Cable group dia.	Part number	Captive center contact	Panel drilling	Note
RG59/RG62	6/75/S	R142 295 000	yes	P01	Single piece body/unit packaging

STRAIGHT BULKHEAD JACK CLAMP TYPE FOR FLEXIBLE CABLES

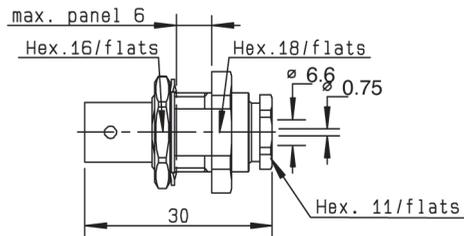

Cable group	Cable group dia.	Part number	Captive center contact	Panel drilling	Note
RG59/RG62	6/75/S	R142 329 000	yes	P14	Panel sealed

For others types of cables (75Ω, 93Ω or BT cables), please see "additional connectors" on page 10-32.

To download data sheets and assembly instructions, visit www.radiall.com & enter the part number in the Search box.

Bold part numbers represent products typically in stock & available for immediate shipment.

See page 8 and 9 for packaging information.

BULKHEAD JACKS AND RECEPTACLES

STRAIGHT BULKHEAD JACKS CRIMP TYPE FOR FLEXIBLE CABLES

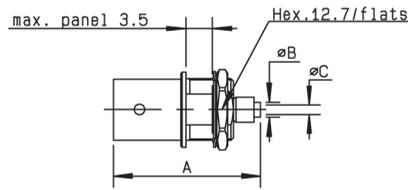

Fig. 1

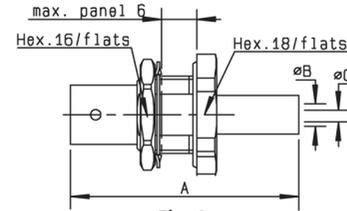

Fig. 2

Cable group	Cable group dia.	Part number	Fig.	Dimensions (mm)			Captive center contact	Panel drilling	Note
				A	B	C			
RG179	2.6/75/S	R142 306 500	1	26	2.95	0.4	yes	P18	Reverse crimping/Commercial version
		R142A 306 500					no		Reverse crimping/ECO version
		R142 306 503					yes		Reverse crimping
		R142 331 011	2	38	1.75	0.4		P14 or P20	Panel sealed/Silver plated
BT3002	3.6/75/D	R142A 325 106	2	36	2.1	0.5	no	P14 or P20	Panel sealed/ECO version
RG59/RG62	6/75/S	R142 334 161	2	35	6.6	0.75	yes	P14 or P20	Panel sealed/Commercial version
RG59/RG62	6/75/S	R142A 334 161	2	35	3.8	0.7			P14 or P20

RECEPTACLES WITH SOLDER POT

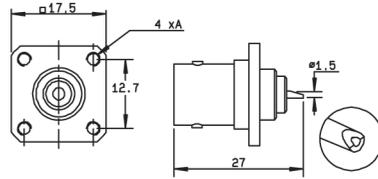

Fig. 1

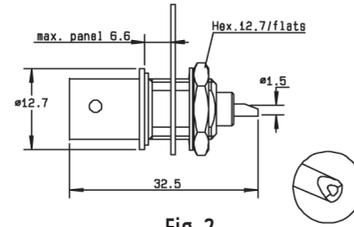

Fig. 2

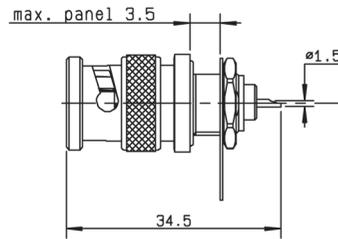

Fig. 3

Part number	Fig.	Captive center contact	Panel drilling	Flange holes A	Note
R142 412 000	1	yes	P07	4 x M2.5	Square flange + unit packaging
R142 562 000	2		P18		Bulkhead female receptacle unit packaging
R142 580 000	3		P18		Bulkhead male receptacle panel sealed + unit packaging

For others types of cables (75Ω, 93Ω or BT cables), please see "additional connectors" on page 10-32.
 To download data sheets and assembly instructions, visit www.radiall.com & enter the part number in the Search box.
Bold part numbers represent products typically in stock & available for immediate shipment.
 See page 8 and 9 for packaging information.

STRAIGHT PCB FEMALE RECEPTACLES

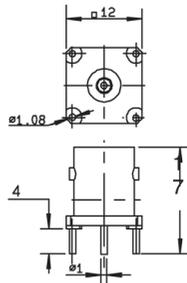

Fig. 1

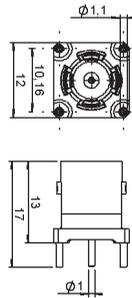
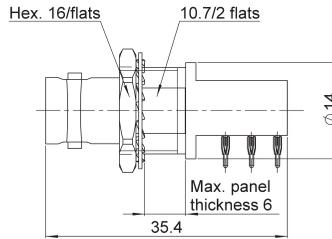

Fig. 2

Part number	Fig.	Captive center contact	Panel drilling	Note
R142 426 020	1	yes	P09	
R142 426 261	2			Commercial version

RIGHT ANGLE PCB FEMALE RECEPTACLE



Part number	Captive center contact	Panel drilling	Note
R142 684 130	yes	P11 and P20	Press-fit pins

To download data sheets and assembly instructions, visit www.radiall.com & enter the part number in the Search box. **Bold** part numbers represent products typically in stock & available for immediate shipment. See page 8 and 9 for packaging information.

ADAPTERS

IN SERIES ADAPTERS

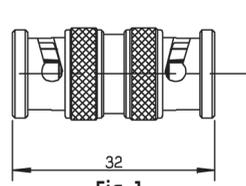

Fig. 1

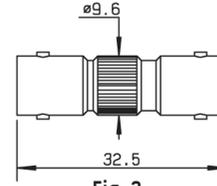

Fig. 2

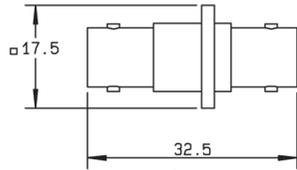

Fig. 3

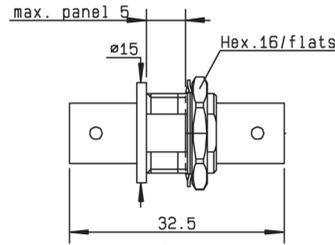

Fig. 4

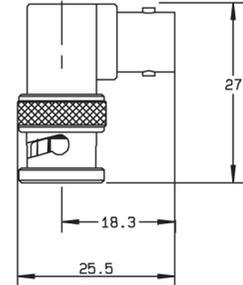

Fig. 5

Part number	Fig.	Captive center contact	Panel drilling	Note
R142 703 000	1	yes		Male - male
R142 704 000	2			Female - female
R142 710 000	3		P01	Female - female square flange
R142 720 000	4		P14	Female - female bulkhead
R142A 720 000	4		P14	Female - female bulkhead - Eco version
R142 723 000	4		P14 or P20	Female - female insulated bulkhead
R142 770 000	5			Male - female right angle

TEE IN SERIES ADAPTERS

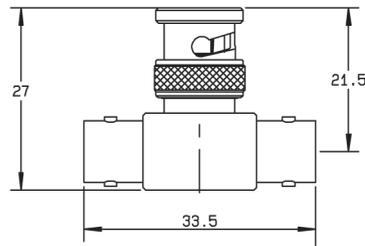

Fig. 1

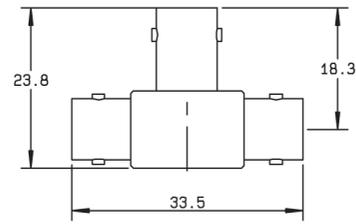

Fig. 2

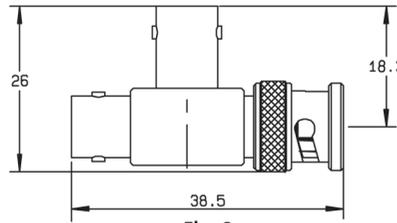

Fig. 3

Part number	Fig.	Captive center contact	Note
R142 780 000	1	yes	Male/female-female tee
R142 782 000	2		Female/female-female tee
R142 789 000	3		Female/female-male tee

To download data sheets and assembly instructions, visit www.radiall.com & enter the part number in the Search box. **Bold part numbers** represent products typically in stock & available for immediate shipment. See page 8 and 9 for packaging information.

ADDITIONAL CONNECTORS

BNC

For more information regarding these connectors, please consult us.

CONNECTORS WITH FLAT GASKET

R141
↓
BNC 50Ω

R142
↓
BNC 75Ω

P/N	Description	Captive center contact
R141 007 000	Straight plug clamp type for 5/50/S+D cable	no
R141 011 000	Straight plug clamp type for 6/75/S cable	
R141 015 000	Straight plug clamp type for 6/75/S cable	
R141 154 000	Right angle plug clamp type for 2.6/50/S+D cable	yes
R141 256 000	Straight square flange jack clamp type for 5/50/S+D cable	no
R141 257 000	Straight square flange jack clamp type for 5/50/S cable	
R141 261 000	Straight square flange jack clamp type for 6/75/S cable	
R142 017 000	Straight plug clamp type for 8/75/S+D cable (unit packaging)	yes

50Ω CONNECTORS FOR 75Ω or 93Ω CABLE

75Ω Cable

P/N	Description	Captive center contact
R141 004 000	Straight plug clamp type for 2.6/75/S cable	yes
R141 011 000	Straight plug clamp type for 6/75/S cable	no
R141 012 000	Straight plug clamp type for 6/75/S cable	
R141 013 000	Straight plug clamp type for 6/75/S cable	
R141 015 000	Straight plug clamp type for 6/75/S cable	no
R141 154 000	Right angle plug clamp type for 2.6/75/D cable	yes
R141 261 000	Straight square flange jack clamp type for 6/75/S cable	no
R141 277 000	Straight insulated square flange jack clamp type for 2.6/75/S cable	yes
R141 278 000	Straight square flange jack clamp type for 2.6/75/S cable	
R141 329 000	Straight bulkhead jack clamp type for 6/75/S cable	

93Ω Cable

P/N	Description	Captive center contact
R141 013 000	Straight plug clamp type for 6/93/S cable	no
R141 077 000	Straight plug crimp type for 3.8/93/S cable	yes

75Ω CONNECTORS FOR 93Ω CABLE

P/N	Description	Packaging
R142 016 000	Straight plug clamp type for 6/93/S cable	unit
R142 078 161	Straight plug crimp type for 3.8/93 cable	100 pieces

CONNECTORS FOR BT OR SPECIAL CABLES

P/N	Description	Packaging
R141 003 420	Straight plug clamp type for 2.2/50D cable	unit
R141 005 000	Straight plug clamp type dia 3.5/50, PPD cable	100 pieces
R141 015 000	Straight plug clamp type dia 6/75/S, 75PD cable	
R142 081 100	Straight plug crimp type for 3.6/75/D, P46431 cable	
R142 081 120	Straight plug crimp type for BT3002, TZ0 75024 cable	unit
R142 081 320	Straight plug crimp type for BT2001 cable	100 pieces
R142 091 161	Straight plug crimp type for ST212 cable	

10-31

CHARACTERISTICS

Test/characteristics	Values/remarks	
Frequency range	DC - 10 GHz	
Impedance	50Ω	
Working voltage	500 Vrms	
Dielectric withstanding voltage Between center conductor and inner screen Between inner screen and outer screen	Unmated connector 1500 Vrms 1000 Vrms	Mated connector 3000 Vrms 1000 Vrms
Temperature range	-55°C / +125°C	

PLUG, JACK AND RECEPTACLE

STRAIGHT PLUG CLAMP TYPE

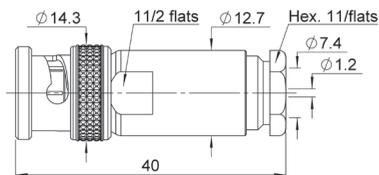

Cable group dia.	Part number
7.3/50/D	R266 010 000

STRAIGHT JACK CLAMP TYPE

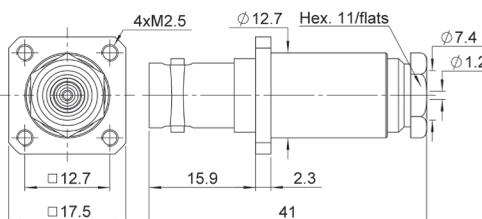

Cable group dia.	Part number	Panel Drilling
7.3/50/D	R266 260 000	P13

RECEPTACLE

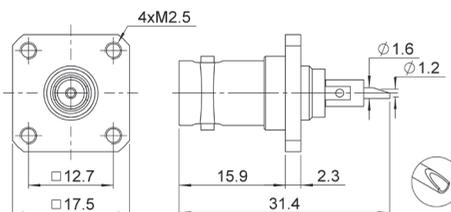

Part number	Panel Drilling
R266 403 000	P13

To download data sheets and assembly instructions, visit www.radiall.com & enter the part number in the Search box.
Bold part numbers represent products typically in stock & available for immediate shipment.
 See page 8 and 9 for packaging information.

P01

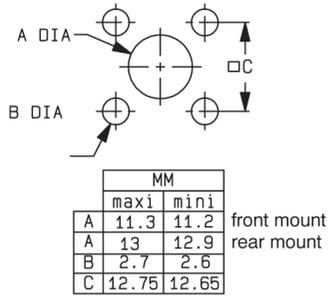

P02

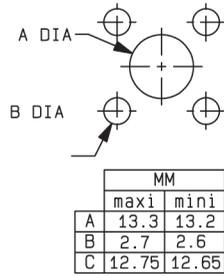

P03

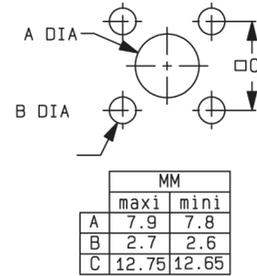

P04

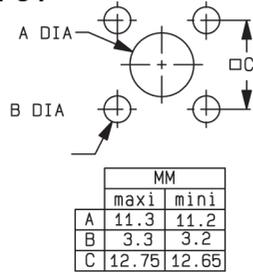

P05

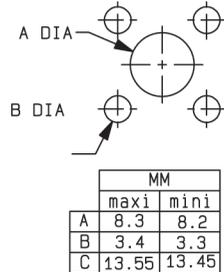

P06

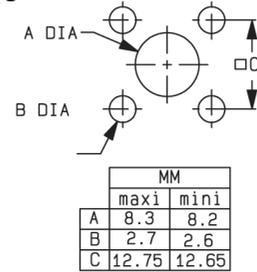

P07

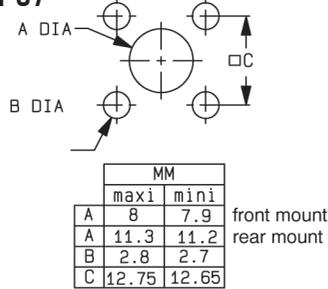

P08

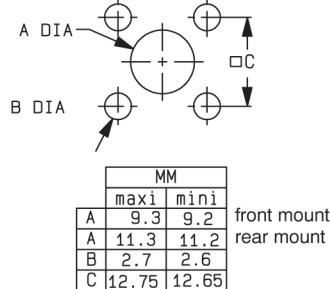

P09

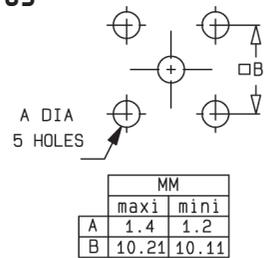

P10

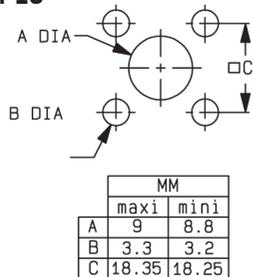

P11

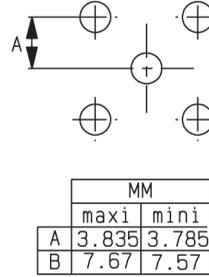

P12

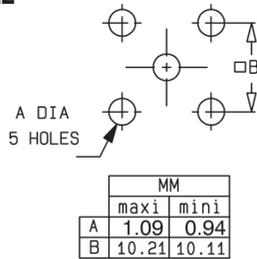

P13

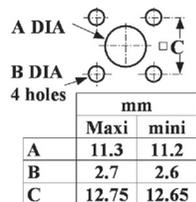

P14

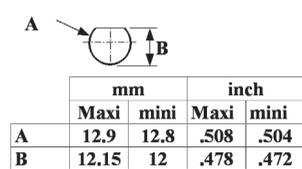

P15

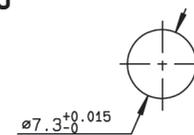

PANEL DRILLING

P16

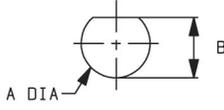

MM		
	maxi	mini
A	11.25	11.15
B	10.43	10.35

P17

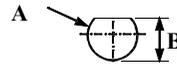

mm		
	Maxi	mini
A	12.9	12.8
B	12.04	11.94

P18

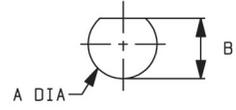

MM		
	maxi	mini
A	9.7	9.6
B	8.9	8.8

P19

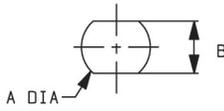

MM		
	maxi	mini
A	9.75	9.65
B	8.65	8.55

P20

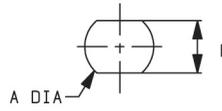

MM		
	maxi	mini
A	12.8	12.7
B	10.9	10.8

P21

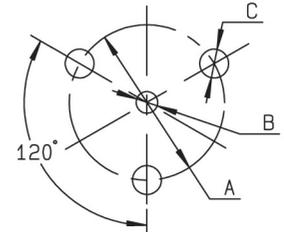

MM		
	maxi	mini
A	8.65	8.55
B	1.3	1.1
C	1.7	1.5

P22

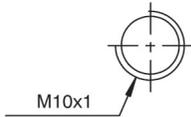

P23

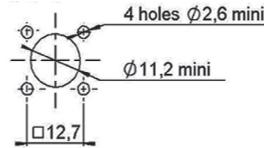

P24

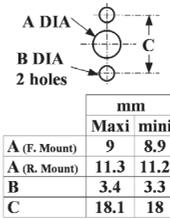

mm		
	Maxi	mini
A (F. Mount)	9	8.9
A (R. Mount)	11.3	11.2
B	3.4	3.3
C	18.1	18

P25

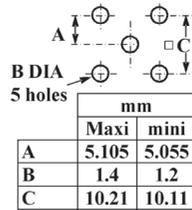

mm		
	Maxi	mini
A	5.105	5.055
B	1.4	1.2
C	10.21	10.11

P26

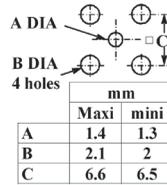

mm		
	Maxi	mini
A	1.4	1.3
B	2.1	2
C	6.6	6.5

P27

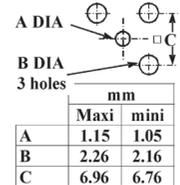

mm		
	Maxi	mini
A	1.15	1.05
B	2.26	2.16
C	6.96	6.76

P28

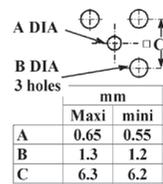

mm		
	Maxi	mini
A	0.65	0.55
B	1.3	1.2
C	6.3	6.2

P29



mm		
	Maxi	mini
A	10.2	10.0
B	9.3	9.2

P30



mm		
	Maxi	mini
A	11.3	11.2
B	12.9	12.8

P31

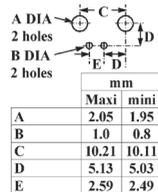

mm		
	Maxi	mini
A	2.05	1.95
B	1.0	0.8
C	10.21	10.11
D	5.13	5.03
E	2.59	2.49

Cable designation	Cable Group Ø / Ω	Imp. Ω	Cable dimensions mm (inch)					Radiall cable if applicable		
			Core type	Core Ø	Insulator Ø	Screen	Outer Ø	P/N	Remark	
RG 174 A/U	2.6 / 50 S	50	7 x 0.16	0.48 (.019)	1.52 (.060)	S	2.79 (.110)	C291 150 000	PVC jacket	
RG 178 B/U	2 / 50 S	50	7 x 0.1	0.30 (.012)	0.84 (.033)	S	1.78 (.070)	C291 145 007	FEP jacket	
RG 178 B/U	2 / 50 S	50	7 x 0.1	0.30 (.012)	0.84 (.033)	S	1.83 (.072)	C291 145 060	PVC jacket	
RG178nonm.	2 / 50 S	50	7 x 0.1	0.29 (.011)	0.84 (.033)	S	1.80 (.071)	C291 140 087	non magnetic / FEP jacket	
RG 179 B/U	2.6 / 75 S	75	7 x 0.1	0.30 (.012)	1.60 (.063)	S	2.54 (.010)	C291 210 007	FEP jacket	
RG 187 A/U	2.6 / 75 S	75	7 x 0.1	0.30 (.012)	1.60 (.063)	S	2.79 (.110)	C291 211 006	PTFE jacket	
RG 188 A/U	2.6 / 50 S	50	7 x 0.17	0.51 (.020)	1.52 (.060)	S	2.79 (.110)	C291 160 006	PTFE jacket	
RG 196 A/U	2 / 50 S	50	7 x 0.1	0.30 (.012)	0.86 (.034)	S	2.03 (.080)	C291 110 006	PTFE jacket	
RG 212 /U	8 / 50 D	50	solid	1.41 (.056)	4.70 (.185)	D	8.43 (.331)	na		
RG 213 /U	10 / 50 S	50	7 x 0.75	2.26 (.089)	7.24 (.285)	S	10.30 (.406)	C291 510 000	PVC jacket	
RG 214 /U	11 / 50 D	50	7 x 0.75	2.25 (.089)	7.24 (.285)	D	10.80 (.425)	C291 600 000	PVC jacket	
RG 215	10 / 50 S	50	7 x 0.75	2.25 (.089)	7.25 (.285)	S	10.29 (.405)	na		
RG 216 /U	11 / 75 D	75	7 x 0.4	1.21 (.048)	7.24 (.285)	D	10.80 (.425)	C291 610 000	PVC jacket	
RG 217 /U	14 / 50 D	50	solid	2.69 (.106)	9.40 (.370)	D	13.84 (.545)	C291 620 000	PVC jacket	
RG 218 /U	22 / 50 S	50	solid	4.95 (.195)	17.27 (.680)	S	22.10 (.870)	C291 630 000	PVC jacket	
RG 223 /U	5 / 50 D	50	solid	0.89 (.035)	2.95 (.116)	D	5.38 (.212)	C291 330 000	PVC jacket	
RG 225 /U	11 / 50 D	50	7 x 0.8	2.38 (.094)	7.24 (.285)	D	10.90 (.429)	C291 605 007	glass fiber jacket	
RG 303 /U	5 / 50 S	50	solid	0.94 (.037)	2.95 (.116)	S	4.32 (.170)	na		
RG 316 /U	2.6 / 50 S	50	7 x 0.17	0.53 (.021)	1.52 (.060)	S	2.49 (.098)	C291 170 007	FEP jacket	
RD 316	2.6 / 50 D	50	7 x 0.17	0.53 (.021)	1.52 (.060)	D	2.80 (.110)	C291 185 067	FEP jacket	
RG 393	10 / 50 D	50	7 x 0.81	2.39 (.094)	7.24 (.285)	D	9.91 (.390)	C291 511 007	FEP jacket	
RG 400	5 / 50 / D	50	19 x 0.19	0.98 (.039)	2.95 (.116)	D	4.95 (.195)	C291 324 007	FEP jacket	
Flexible cable BT approved										
RD 179	2.6 / 75 D	75	7 x 0.10	0.30 (.012)	1.6 (.063)	D	3.07 (.121)	C291 230 080	LSOH jacket	
BT 3002	3.6 / 75 D	75	solid	0.31 (.012)	1.95 (.077)	D	3.55 (.140)	C291 246 046	FEP jacket	
BT 2002	5 / 75 D	75	7 x 0.20	0.60 (.024)	2.5 (.098)	D	5.1 (.200)	C291 333 080	FEP jacket	
Semi rigid cables MIL-C-17 standard										
RG 401 /U	.250"	50	solid	1.63 (.064)	5.31 (.209)	--	6.35 (.250)	C291 870 001	copper tubing	
RG 401 alu	.250"	50	solid	1.63 (.064)	5.31 (.209)	--	6.35 (.250)	C291 874 187	tinned alu tubing	
RG 402 /U	.141"	50	solid	0.92 (.036)	2.98 (.117)	--	3.58 (.141)	C291 860 001	copper tubing	
RG 402 tin	.141"	50	solid	0.92 (.036)	2.98 (.117)	--	3.58 (.141)	C291 862 005	tinned copper tubing	
RG402silver	.141"	50	solid	0.92 (.036)	2.98 (.117)	--	3.58 (.141)	C291 861 066	silvered copper tubing	
RG 402 alu	.141"	50	solid	0.92 (.036)	2.98 (.117)	--	3.58 (.141)	C291 864 187	tinned alu tubing	
RG402nonm.	.141"	50	solid	0.92 (.036)	2.98 (.117)	--	3.58 (.141)	C291 861 061	non magnetic / copper tubing	
RG 405 /U	.085"	50	solid	0.51 (.020)	1.68 (.066)	--	2.20 (.087)	C291 850 001	copper tubing	
RG 405 tin	.085"	50	solid	0.51 (.020)	1.68 (.066)	--	2.20 (.087)	C291 850 005	tinned copper tubing	
RG 405 alu	.085"	50	solid	0.51 (.020)	1.68 (.066)	--	2.20 (.087)	C291 844 187	tinned alu tubing	
RG405nonm.	.085"	50	solid	0.51 (.020)	1.68 (.066)	--	2.20 (.087)	C291 851 001	non magnetic / copper tubing	
.047"	.047"	50	solid	0.29 (.011)	0.94 (.037)	--	1.19 (.047)	C291 855 001	copper tubing	
.047" tin	.047"	50	solid	0.29 (.011)	0.94 (.037)	--	1.19 (.047)	C291 855 065	tinned copper tubing	
Hand-formable cable										
Hand-formable	.085"	50	solid	0.51 (.020)	1.63 (.064)	--	2.21 (.087)	C291 844 065	tin soaked braid	
Hand-formable	.141"	50	solid	0.92 (.036)	2.95 (.116)	--	3.50 (.138)	C291 864 065	tin soaked braid	
Hand-formable	.141"	50	solid	0.92 (.036)	2.98 (.117)	--	4.05 (.159)	C291 866 378	FEP jacket	
Hand-formable	.141"	50	solid	0.92 (.036)	2.98 (.117)	--	4.50 (.177)	C291 866 270	LSZH jacket	
Corrugated cables (with helical or ringed/annular copper tube)										
Flexible	1/4"	50	solid	2.38 (.094)	6.40 (.252)	--	8.70 (.343)	na	ringed/annular tube	
Flexible	1/2"	50	solid	4.80 (.189)	11.6 (.457)	--	16.35 (.644)	C291 972 085	ringed/annular tube	
Flexible	7/8"	50	solid	9.13 (.359)	22.5 (.866)	--	27.7 (1.091)	na	ringed/annular tube	
Flexible	1 1/4"	50	solid	12.7 (.500)	32.5 (1.28)	--	39.5 (1.55)	na	ringed/annular tube	
Flexible	1 5/8"	50	solid	17.3 (.681)	43.5 (1.71)	--	50.5 (1.99)	na	ringed/annular tube	
Super flexible	1/4"	50	solid	1.90 (.075)	4.70 (.185)	--	7.40 (.291)	C291 993 080	helical tube	
Super flexible	3/8"	50	solid	2.60 (.102)	6.30 (.248)	--	10.8 (.425)	C291 996 070	helical tube	
Super flexible	1/2"	50	solid	3.60 (.142)	8.70 (.343)	--	13.2 (.520)	C291 994 080	helical tube	
Super flexible	7/8"	50	tube	9.04 (.356)	23.62 (.930)	--	27.48 (1.082)	C291 996 580	helical tube	

Note: S = single braid. D = dual braid.

For more information about cables manufactured by Radiall, please consult our online catalog.

www.radiall.com

X-ON Electronics

Largest Supplier of Electrical and Electronic Components

Click to view similar products for [RF Adapters - In Series](#) category:

Click to view products by [Radiall](#) manufacturer:

Other Similar products are found below :

[5916-1103-603](#) [5919-1503-000](#) [651A505](#) [82-5552](#) [9030-9523-502](#) [PN2C](#) [A0407000](#) [R114703000W](#) [R125771001](#) [R141710000W](#)
[R141723161](#) [R141730000](#) [R143730700](#) [R143770000](#) [R161703000W](#) [R161753000W](#) [R161791530W](#) [R201705000](#) [R222705200](#)
[R222M40010W](#) [R223703180](#) [R316754000](#) [R405006000](#) [R443162000](#) [AD78TL](#) [HRM-513S](#) [1996352-2](#) [2157155-1](#) [252169-75](#) [AD158](#)
[2101130-1](#) [252186](#) [R114704000W](#) [R114720000W](#) [R125705001](#) [R125705701](#) [R125771000](#) [R125771001W](#) [R127704001](#) [R127.870.001](#)
[R127872001](#) [R141717000](#) [R142710000](#) [R142723000](#) [R143703000](#) [R143704000](#) [R143705700](#) [R161715000W](#) [R161771000W](#) [R176754000](#)