

# ADAPTERS AND CAPS

## CROSS AND TEE IN SERIES ADAPTERS

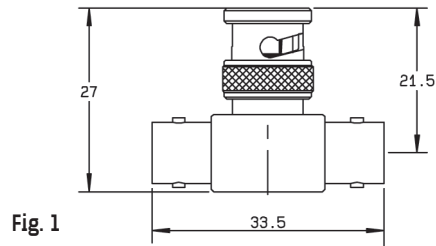

Fig. 1

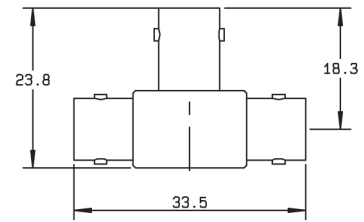

Fig. 2

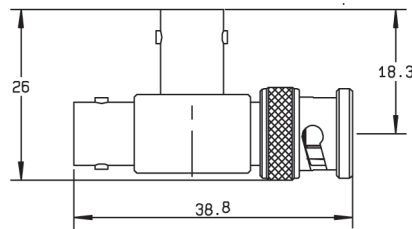

Fig. 3

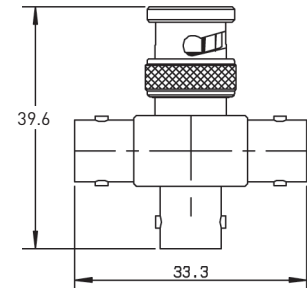

Fig. 4

Part number	Fig.	Captive center contact	Note
R141 780 000	1	yes	Male/female-female tee
R141 782 000	2		Female/female-female tee
R141 789 000	3		Female/female-male tee
R141 799 000	4		Male/female-female-female cross/unit packaging

## MALE AND FEMALE CAPS

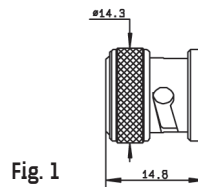

Fig. 1

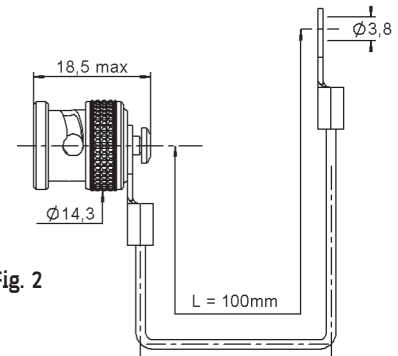

Fig. 2

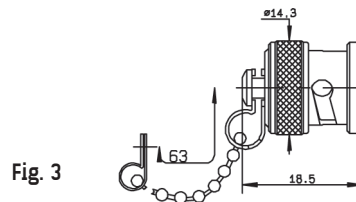

Fig. 3

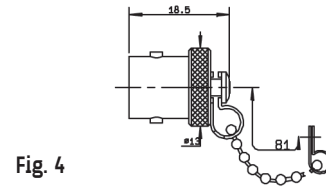

Fig. 4

Part number	Fig.	Note
R141 802 000	1	Male
R141 805 000	2	Male with cord
R141 812 000	3	Male with chain
R141 842 000	4	Female with chain
R141 862 000	3	Male short circuit/with chain

## X-ON Electronics

Largest Supplier of Electrical and Electronic Components

*Click to view similar products for [RF Adapters - Tee category](#):*

*Click to view products by [Radiall manufacturer](#):*

Other Similar products are found below :

[R142782000](#) [R114780000W](#) [R142780000W](#) [R143780000](#) [R143782000](#) [344A505](#) [TN2](#) [443A505](#) [5207-1501-000](#) [R125780000](#) [BNC-TA-JJJ\(40\)](#) [R125780001](#) [034-1023](#) [ADP-BNCF-2BNCF](#) [73148-5003](#) [31-208-1051](#) [CT3312](#) [53S301-K00N5](#) [CT2411](#) [43\\_SMB-50-0-2/111\\_NE](#) [32K301-K00L5](#) [46\\_SMA-50-0-1/111\\_NE](#) [51S303-K00N5](#) [32S301-K00L5](#) [43\\_N-50-0-1/133\\_NE](#) [CPAD705](#) [BN153](#) [031-208-1051](#) [031-70036](#) [082-102](#) [112455](#) [112456](#) [112459](#) [112461](#) [112462](#) [112567](#) [112590](#) [122354](#) [122356](#) [132216](#) [132217](#) [142300](#) [172125](#) [172127](#) [172233](#) [21900](#) [31-208](#) [31-208-RFX](#) [31-2208](#) [31-8](#)