

PAGE 1/3	ISSUE 03-03-17B	SERIES BNC 75 HDTV	PART NUMBER R142500740
----------	-----------------	--------------------	------------------------

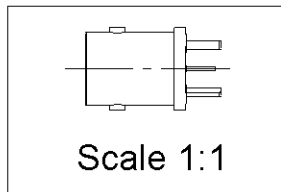

PANEL CUT OUT

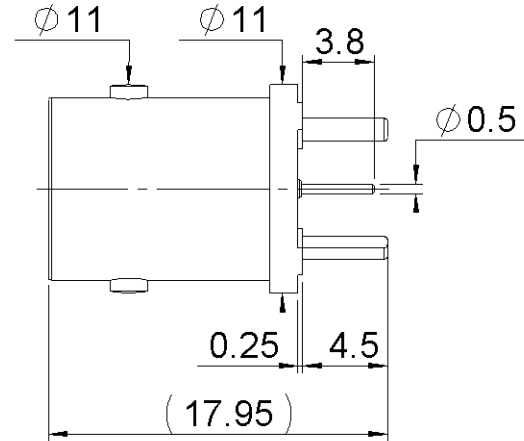
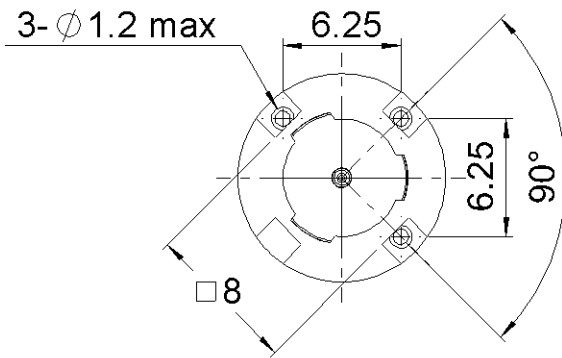
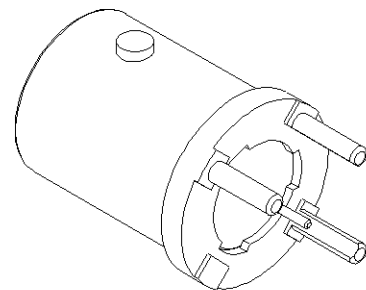
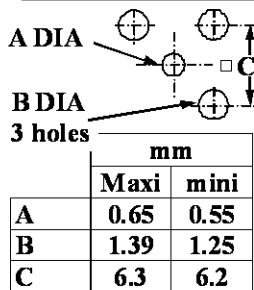

All dimensions are in mm.

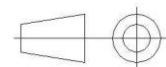

COMPONENTS	MATERIALS	PLATING (µm)
Body	ZAMAK	NICKEL .
Center contact	BERYLLIUM COPPER	GOLD OVER NICKEL
Outer contact		
Insulator	PTFE	
Gasket		
Others parts		
-	-	-
-	-	-

PAGE 2/3	ISSUE 03-03-17B	SERIES BNC 75 HDTV	PART NUMBER R142500740
----------	------------------------	---------------------------	-------------------------------

PACKAGING

Standard	Unit	Other
60	Contact us	Contact us

ELECTRICAL CHARACTERISTICS

Impedance		75	Ω
Frequency		DC-12	GHz
VSWR	*1.05	+	0.0350 x F(GHz) Maxi
Insertion loss		0.1*	√F(GHz) dB Maxi
RF leakage	- (-57**	- F(GHz) dB Maxi
Voltage rating		500	Veff Maxi
Dielectric withstanding voltage		1500	Veff mini
Insulation resistance		5000	MΩ mini

ENVIRONMENTAL

Operating temperature	-65/+165	°C
Hermetic seal	NA	Atm.cm3/s
Panel leakage	NA	

MECHANICAL CHARACTERISTICS

Center contact retention			
Axial force – Mating End		18	N mini
Axial force – Opposite end		10	N mini
Torque		NA	N.cm mini
Recommended torque			
Mating		NA	N.cm
Panel nut		NA	N.cm
Mating life		500	Cycles mini
Weight		3.5800	g

SPECIFICATION

OTHER CHARACTERISTICS

Assembly instruction:**NA**

Others:

Data speed rate up to 12.5 Gb/s
***Coaxial Transmission Line Only**
****Interface only**

PAGE 3/3	ISSUE 03-03-17B	SERIES BNC 75 HDTV	PART NUMBER R142500740
----------	-----------------	--------------------	------------------------

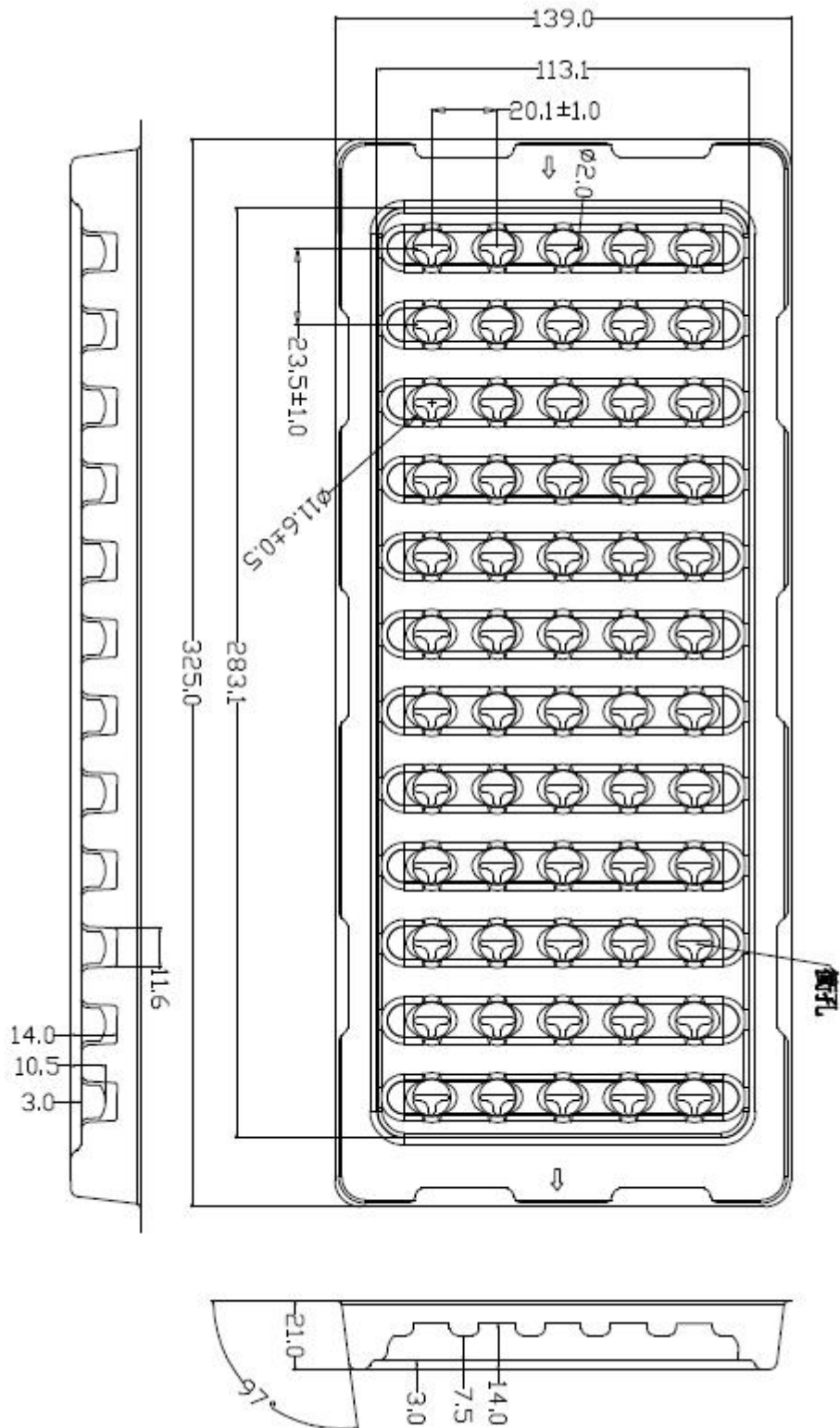

X-ON Electronics

Largest Supplier of Electrical and Electronic Components

Click to view similar products for [RF Connectors / Coaxial Connectors](#) category:

Click to view products by [Radiall](#) manufacturer:

Other Similar products are found below :

[8915-1511-000](#) [89674-0827](#) [6001-7071-019](#) [6002-7051-003](#) [6002-7551-202](#) [6059674-1](#) [619550-1](#) [630059-000](#) [M39030/3-01N](#) [6500-7071-046](#) [6769](#) [CX050L2AQ](#) [7002-1541-010](#) [7002-1542-011](#) [7004-1512-000](#) [7009-1511-004](#) [7010-1511-000](#) [7029-1511-060](#) [7101-1541-010](#) [7101-1571-002](#) [7145-1521-002](#) [7203-1571-003](#) [7209-1511-011](#) [7210-1511-015](#) [7210-1511-019](#) [73137-5015](#) [73216-2241](#) [73404-2300](#) [7405-1521-005](#) [7405-1521-802](#) [8527](#) [8547](#) [FS11V](#) [877931](#) [9049-9513-000](#) [9074-9513-000](#) [9101-9573-002](#) [910A205F](#) [9130-9573-002](#) [PL11SC-026](#) [PL375-33](#) [PL40-5](#) [PL74C-221](#) [PL75MC-217](#) [PL803-7](#) [980-8666-005](#) [1200690078](#) [1-201144-1](#) [R107003010W](#) [R110A172100](#)