

STRAIGHT PLUG CRIMP TYPE

R161.092.200

CABLE 5/50 D

Series : N

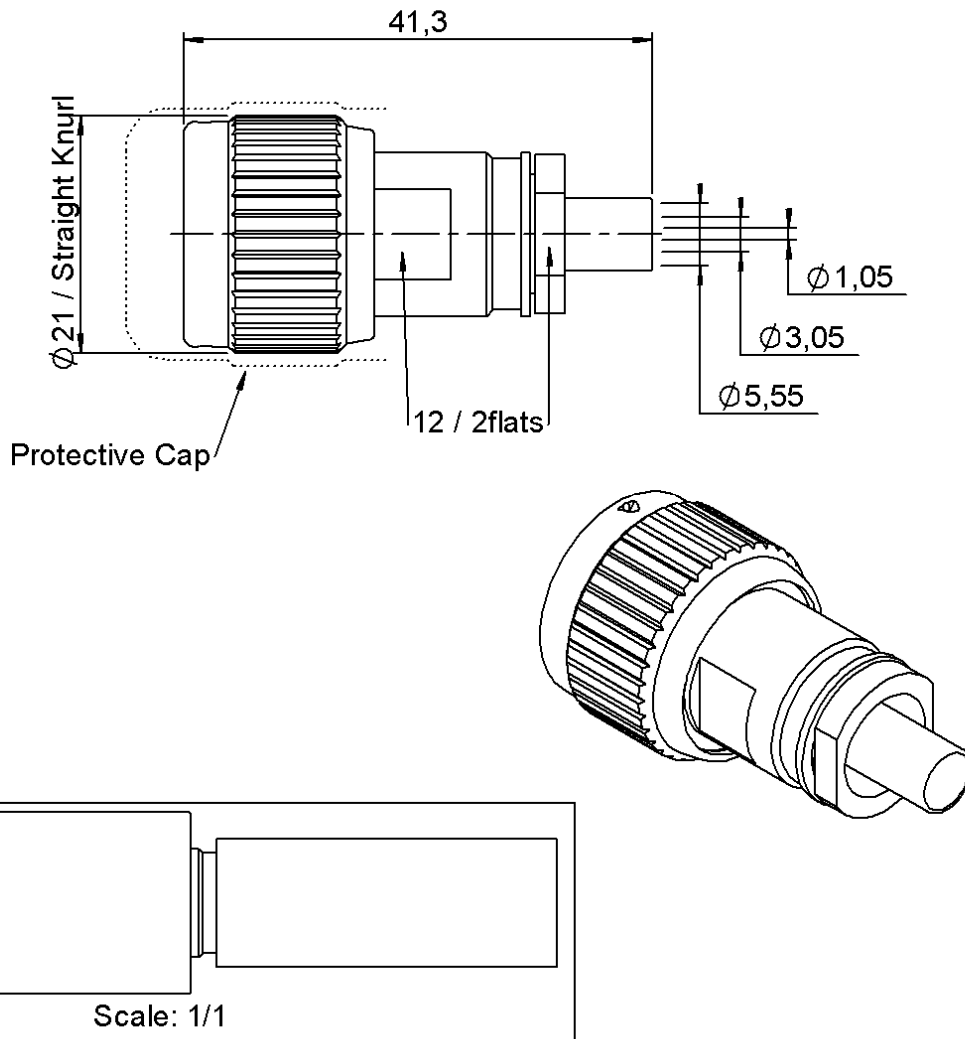

All dimensions are in mm.

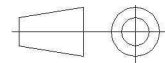

COMPONENTS	MATERIALS	PLATINGS (µm)
BODY	BRASS	NICKEL 2
CENTER CONTACT	BRASS	GOLD 1.3 OVER NICKEL2
OUTER CONTACT	BRASS	NICKEL 2
INSULATOR	PTFE	
GASKET	SILICONE RUBBER	
OTHERS PARTS	BRASS	NICKEL 2
-	-	-
-	-	-

Issue : 1406 G

In the effort to improve our products, we reserve the right to make changes judged to be necessary.



STRAIGHT PLUG CRIMP TYPE

R161.092.200

CABLE 5/50 D

Series : N

PACKAGING

Standard	Unit	Other
50	'W' option	Contact us

SPECIFICATION

ASN-E0462 F01 - -

CABLE ASSEMBLY

Stripping	a	b	c	d	e	f
mm	9,00	9,00	23,0	0,00	0,00	0,00

ELECTRICAL CHARACTERISTICS

Impedance	50	Ω
Frequency	0-3	GHz
VSWR	1.15 + 0,0000	x F(GHz) Maxi
Insertion loss	0.048	\sqrt{F} (GHz) dB Maxi
RF leakage	- (101)	- F(GHz)) dB mini
Voltage rating	850	Veff Maxi
Dielectric withstanding voltage	1500	Veff mini
Insulation resistance	5000	M Ω mini

Assembly instruction :

Recommended cable(s)

RG 142
RG 400
RG 223
KX 23
RG 142 FTX

Cable retention

- pull off **200** N mini
- torque **NA** N.cm

MECHANICAL CHARACTERISTICS

Center contact retention		
Axial force – Mating end	27	N mini
Axial force – Opposite end	27	N mini
Torque	NA	N.cm mini

Recommended torque		
Mating	130	N.cm
Panel nut	NA	N.cm
Clamp nut	370	N.cm
A/F clamp nut	12,0000	mm

Mating life	500	Cycles mini
Weight	37,4000	g

TOOLING

Part Number	Description	Hexagon
R282293000	CRIMPING TOOL M22520/5-01	-
R282235011	CRIMPING DIES M22520/5-11	5.41
Or - (ou)		
R282223000	CRIMPING TOOL	5.41
And - (et)		
282291	CRIMPING TOOL M22520/1-01	2x4 (pos. 7)
282997	POSITIONER FOR TOOL 282.291(M22520/1-13)	rouge

ENVIRONMENTAL

Operating temperature	-55/+155	$^{\circ}$ C
Hermetic seal	NA	Atm.cm3/s
Panel leakage	NA	

OTHERS CHARACTERISTICS

Issue : 1406 G

In the effort to improve our products, we reserve the right to make changes judged to be necessary.



STRAIGHT PLUG CRIMP TYPE

R161.092.200

CABLE 5/50 D

Series : N

COMPONENTS

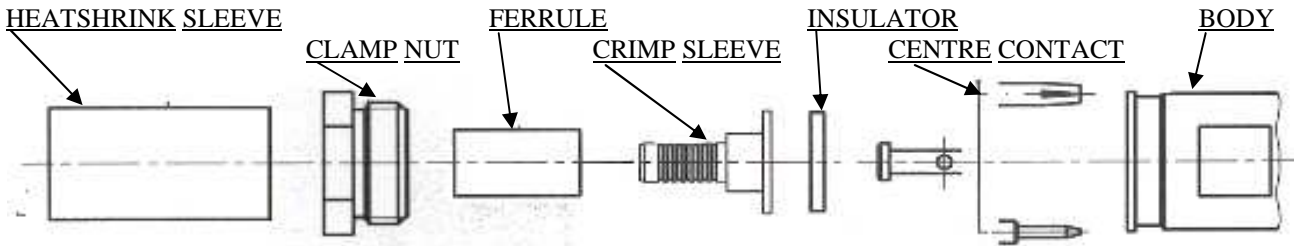

1

Slide onto the cable the heatshrink and the ferrule.
Strip the cable.

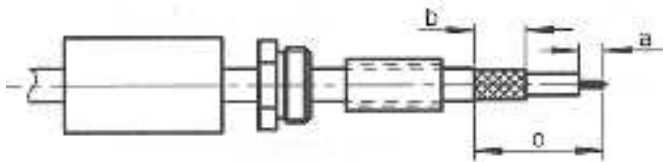

2

Slide the clamp nut onto the crimp sleeve.
Slide sub-assembly under the braid.
Slide ferrule over the braid against clamp nut. (In direction F)
Crimp the ferrule with crimping tool + dies.

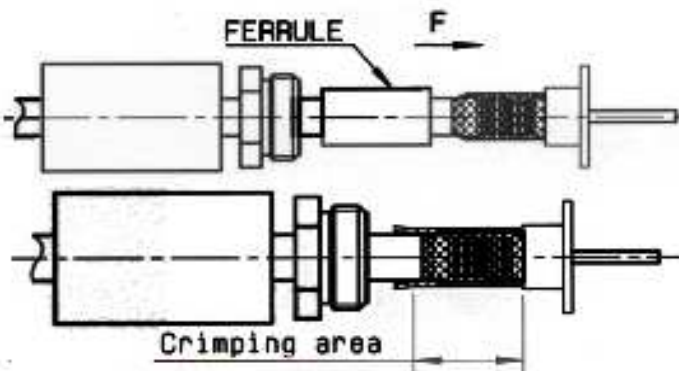

3

Cut the dielectric flush to crimp sleeve.
Mount insulator against crimp sleeve.

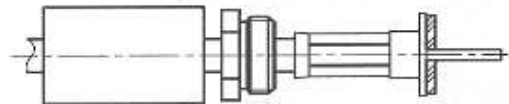

4

Slide the centre contact onto the cable inner conductor against insulator.
Crimp centre contact with crimping tool and positioner.

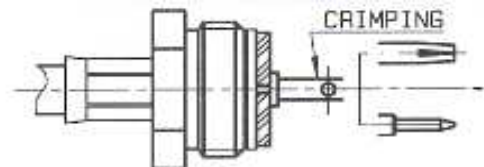

heatshrink sleeve not shown

5

Screw sub-assembly into the connector body.
(recommended coupling see connector TDS)
Slide sleeve over ferrule and Heatshrink sleeve in place.

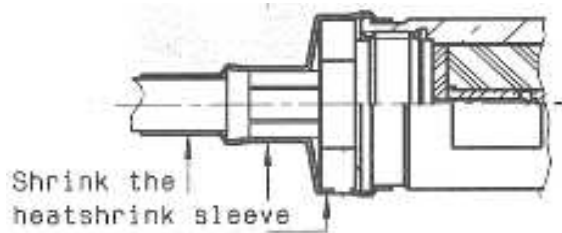

Issue : 1406 G

In the effort to improve our products, we reserve the right to make changes judged to be necessary.



RADIALL®

X-ON Electronics

Largest Supplier of Electrical and Electronic Components

Click to view similar products for [RF Connectors / Coaxial Connectors](#) category:

Click to view products by [Radiall](#) manufacturer:

Other Similar products are found below :

[8915-1511-000](#) [89674-0827](#) [6001-7071-019](#) [6002-7051-003](#) [6002-7551-202](#) [6059674-1](#) [619550-1](#) [630059-000](#) [M39030/3-01N](#) [6500-7071-046](#) [6769](#) [CX050L2AQ](#) [7002-1541-010](#) [7002-1542-011](#) [7004-1512-000](#) [7009-1511-004](#) [7010-1511-000](#) [7029-1511-060](#) [7101-1541-010](#) [7101-1571-002](#) [7145-1521-002](#) [7203-1571-003](#) [7209-1511-011](#) [7210-1511-015](#) [7210-1511-019](#) [73137-5015](#) [73216-2241](#) [73404-2300](#) [7405-1521-005](#) [7405-1521-802](#) [8527](#) [8547](#) [FS11V](#) [877931](#) [9049-9513-000](#) [9074-9513-000](#) [9101-9573-002](#) [910A205F](#) [9130-9573-002](#) [PL11SC-026](#) [PL375-33](#) [PL40-5](#) [PL74C-221](#) [PL75MC-217](#) [PL803-7](#) [980-8666-005](#) [1200690078](#) [1-201144-1](#) [R107003010W](#) [R110A172100](#)