

STRAIGHT JACK FULL CRIMP-TYPE CABLE 5/50 S	R161.237.000 SERIES N
---	--

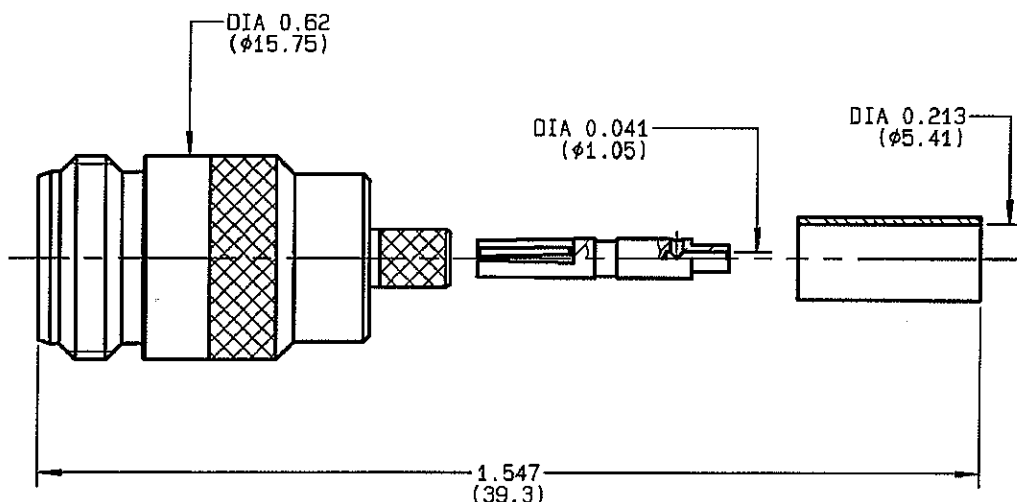

NOMINAL IMPEDANCE	50 Ω	CABLES : BSSM 742
FREQUENCY RANGE	0-11 GHz	KX 15
TEMPERATURE RATING	-55/+155 °C	RG 141
V.S.W.R	1.30 + x F(GHz)Maxi	RG 58
RF INSERTION LOSS	0.048 √F(GHz) dB Maxi	
VOLTAGE RATING	850 Veff Maxi	
DIELECTRIC WITHSTANDING VOLTAGE	1500 Veff Mini	
INSULATION RESISTANCE	5000 MΩMini	OTHERS CHARACTERISTICS
HERMETIC SEAL	NA Atm.cm ³ /s	CABLE RETENTION
LEAKAGE (pressurized only)	NA	150 N Mini
MECHANICAL DURABILITY	500 Cycles	CENTER CONTACT RETENTION
WEIGHT	25.6 gr	Axial force - mating end
SPECIFICATION		27 N Mini
		Axial force - opposite end
		27 N Mini
		Torque
		NA cm.N Mini
		RECOMMENDED TORQUES
		Mating
		NA cm.N
		Panel nut
		NA cm.N
		Clamp nut
		NA cm.N

CONNECTOR PARTS	MATERIALS	FINISH
BODY	BRASS	BBR 2
OUTER CONTACT	BRASS	BBR 2
CENTER CONTACT	BERYLLIUM COPPER	GOLD 0.5 OVER NICKEL 2
INSULATOR	PTFE	-
GASKET	-	-
OTHERS PIECES	BRASS	BBR 2

(all values are given in micrometers)

BONDIMINI

ISSUE 0515D01	CREATION DATE 21/07/1993	FILE PART-NUMBER EPC 96-07	 RADIALL®
-------------------------	------------------------------------	--------------------------------------	--

The information given here is subject to change without notices.
Design changes may be in order to improve the product.

Connect to the future



R161.237.000

ISSUE 0515 D01 SERIES N

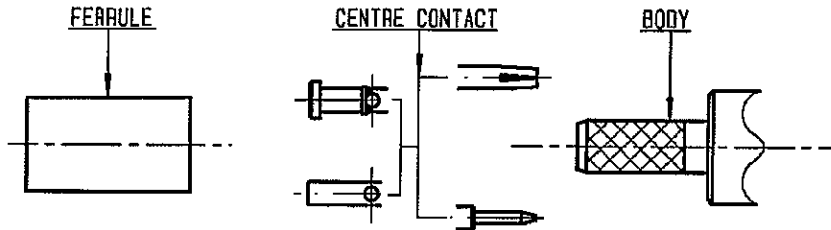

①

Slide onto the cable the ferrule
Strip the cable .

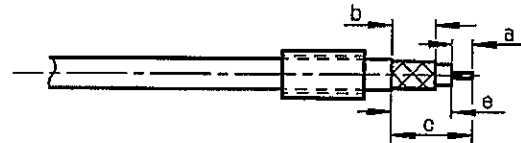

Stripping	a	b	c	d	e
inch	0.177	0.315	0.551	0	0.374
mm	4.5	8	14		9.5

②

Slide on centre contact until it bottoms against cable dielectrique .
Solder or crimp centre contact .
Crimping tool : R282 223 000 (Hex. : .068)
or R282 293 000 (M22520/5-01)
+ dies R282 235 011 (M22520/5-11) .

SOLDER / CRIMPING

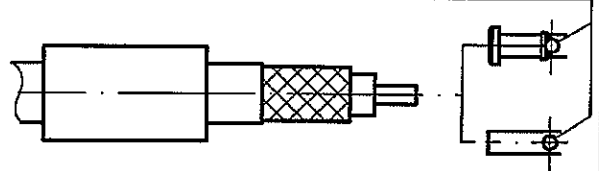

③

Fan the braid .
Slide cable into the body until bottoms against insulator .
Slide ferrule over the braid .
(In direction F)

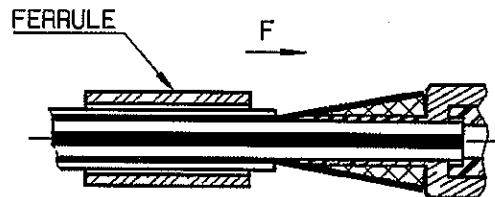

④

Crimp the ferrule with crimping tool
R 282 223 000 (Hex. : .213) or
crimping tool R282 293 000 (M22520/5-01)
+ dies R282 235 011 (M22520/5-11)
Cut the excess of braid .

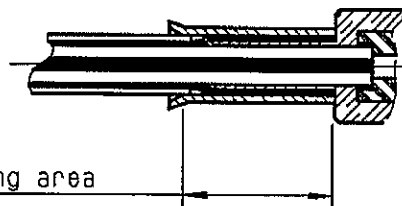

Crimping area

BONDINI

X-ON Electronics

Largest Supplier of Electrical and Electronic Components

Click to view similar products for [RF Connectors / Coaxial Connectors](#) category:

Click to view products by [Radiall](#) manufacturer:

Other Similar products are found below :

[8915-1511-000](#) [89674-0827](#) [6001-7071-019](#) [6002-7051-003](#) [6002-7551-202](#) [6059674-1](#) [619550-1](#) [630059-000](#) [M39030/3-01N](#) [6500-7071-046](#) [6769](#) [CX050L2AQ](#) [7002-1541-010](#) [7002-1542-011](#) [7004-1512-000](#) [7009-1511-004](#) [7010-1511-000](#) [7029-1511-060](#) [7101-1541-010](#) [7101-1571-002](#) [7145-1521-002](#) [7203-1571-003](#) [7209-1511-011](#) [7210-1511-015](#) [7210-1511-019](#) [73137-5015](#) [73216-2241](#) [73404-2300](#) [7405-1521-005](#) [7405-1521-802](#) [8527](#) [8547](#) [FS11V](#) [877931](#) [8808-1511-001](#) [9074-9513-000](#) [9101-9573-002](#) [910A205F](#) [9130-9573-002](#) [PL11SC-026](#) [PL375-33](#) [PL40-5](#) [PL74C-221](#) [PL75MC-217](#) [PL803-7](#) [1200690078](#) [1-201144-1](#) [R107003010W](#) [R110A172100](#) [R112186000](#)