

N / Composite N / N 18 GHz series

R161 / R162 / R163

	Pages
Introduction	12-4 to 12-5

N 50Ω and Composite N

Interface	12-6
Characteristics	12-8 to 12-9
Plugs	12-12 to 12-14
Jacks	12-14 to 12-17
Receptacles	12-18 and 12-20
Composite N receptacle	12-19
Adapters	12-21
Caps	12-22
Accessories	12-22

N 18 GHz

Interface	12-6 to 12-7
Characteristics	12-10
Plugs	12-23
Jacks	12-23
Adapters	12-23

N 75Ω

Interface	12-7
Characteristics	12-11
Plugs	12-24
Jacks	12-24
Receptacles	12-25
Adapters	12-25
Panel drilling	12-26

INTRODUCTION



50Ω	DC - 11 GHz (standard N) DC - 18 GHz (N 18 GHz)
75Ω	DC - 1.5 GHz

GENERAL

- Standard coaxial connectors
- Screw-on coupling
- High durability and proven strength
- High power rating
- Excellent RF performance

APPLICATIONS

- Wireless communications
- Civil and military radio-telecommunication equipment
- Countermeasure
- Navy equipment
- Industrial applications

APPLICABLE STANDARDS

- MIL-C-39012 / MIL STD 348-304
- CEI 169-16
- CECC 22210
- NF-C-93566
- DS 8811

NEW

COMPOSITE RECEPTACLES

Radiall introduces its new composite N receptacles. Composite N connectors offer outstanding electrical performance and are the best compromise in terms of weight, cost and mechanical characteristics to replace existing brass technology.

Features and benefits

Intermateable with standard N connectors for backward compatibility

Evenly distributed contact pressure for a better intermodulation

Composite material to remove any potential corrosion in outdoor applications

Color coding, optional

Light material for weight saving for cost sensitive equipments

Best material selection for outstanding torque resistance

Many center contact options available for an easy adaptation to customers application

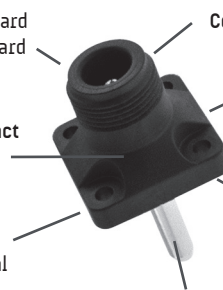

NEW

POWER SWITCHING CONNECTORS

It's a "two in one" solution replacing the existing standard RF switches by integrating the switch function into a receptacle connector. This solution provides a unique means of switching between two RF signal paths.

As user friendly as a standard connector, the switch is mechanically activated by mating and unmating the connector.

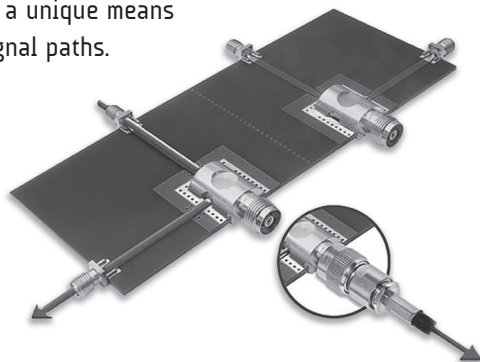

Main advantages

- Reliable
- Increases the density
- Excellent electrical and mechanical performances
- Reduction of the cost of ownership
- Betty RF adaptation
- Good isolation
- Available in right or left versions

Main applications

- Telecom applications
- RF power amplifiers

INTRODUCTION

N/N 18 GHz

Radiall offers a wide range with a standard plating finish:
BBR (Bright Bronze Radiall) = high performance non magnetic alloy.

• FULL CRIMP MODELS

A fast and reliable attachment system that can be easily achieved in a field environment, with minimum easy-to-use tooling (including models for 2 and 2.6 mm dia cables). All our full crimp connectors are single piece body.

• LOW INTERMODULATION CONNECTORS

Radiall maintains extensive knowledge in this field and has developed N series connectors that are specially designed for base stations of applications where the elimination of intermodulation products is of the utmost importance:

- optimized for 900 - 1800 MHz bands (and able to work up to 11 GHz like the standard models),
- IMP_3 performance = -110 dBm (- 153 dBc),
- new models for corrugated and low loss flexible cables,
- high performance non magnetic materials and platings (silver and BBR),
- new 6 flats coupling nut (18 mm), allowing high coupling torque (170 Ncm) thanks to torque wrench,
- non slotted outer contact.

• 18 GHz PRECISION CONNECTORS

Suitable for medium to high power applications and precision microwave test equipment. Long life duration and enhanced electrical performance in severe environmental conditions. N18 series mate with all 50 ohms N connectors.

• VERY LOW INTERMODULATION CABLE ASSEMBLIES

For severe intermodulation conditions, we propose a range of low intermodulation cable assemblies $IMP_3 \leq 125$ dBm.

For further details, please read our:

- Intermodulation application guide (D1 032 DE)
- BBR plating application guide (D1 030 DE)

IMPORTANT: the 50 Ω and the 75 Ω connectors are **NOT INTERMATEABLE**, resulting in the interface destruction.

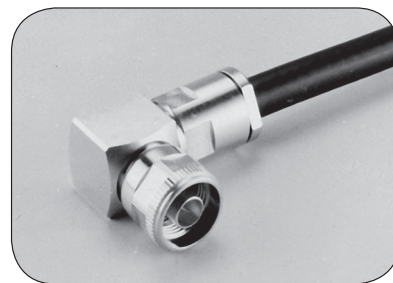
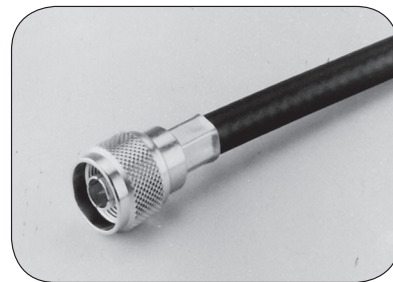
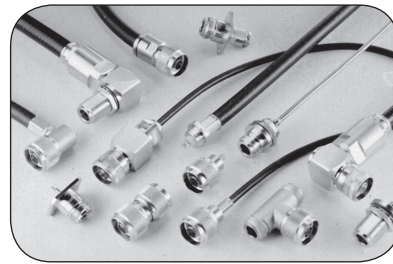

INTERFACE N 50Ω

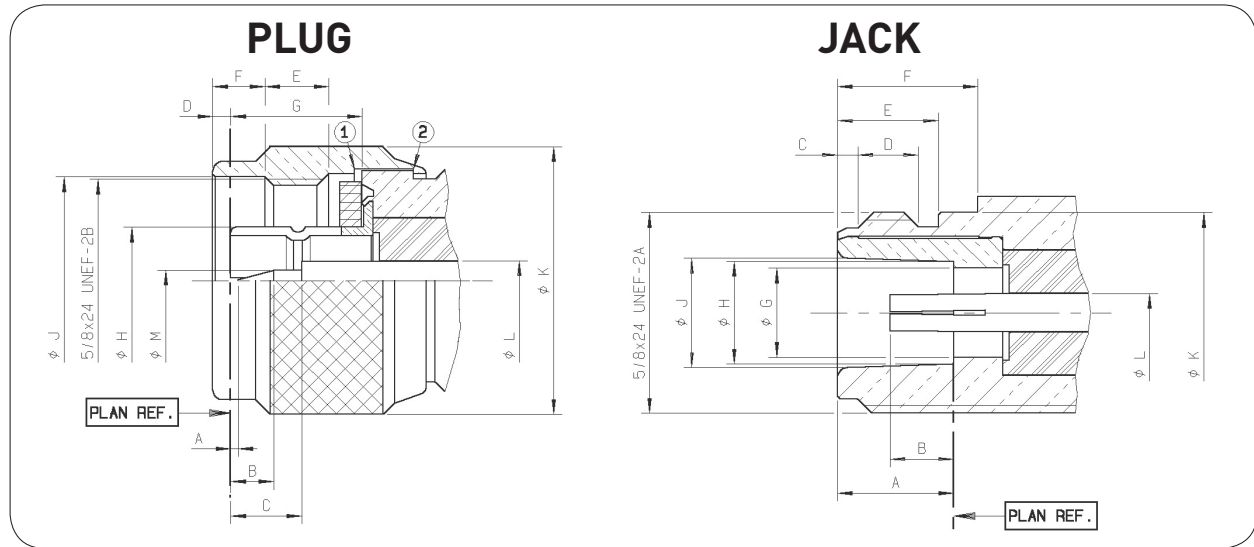

LETTER	mm		inch	
	min.	max.	min.	max.
A	0.13	1.03	.005	.13
B	2.80	3.56	.110	.140
C	5.33	5.83	.210	.229
D	1	2	.016	.066
E	4.54	5.39	.179	.212
F	4.05	4.20	.159	.165
G	10.23	10.43	.403	.411
H DIA	8.27	8.37	.326	.329
J DIA	16.1	16.2	.634	.638
K DIA	20.9	21	.823	.827
L DIA	3.01	3.05	.118	.120
M DIA	1.63	1.67	.064	.066

LETTER	mm		inch	
	min.	max.	min.	max.
A	9.05	9.19	.356	.362
B	4.75	5.25	.187	.207
C	1.20	1.95	.047	.077
D	4.4	5.1	.173	.201
E	6.8	9	.268	.354
F	10.9	11.2	.429	.441
G DIA	6.98	7.02	.275	.276
H DIA	8.03	8.13	.316	.320
J DIA	8.53	8.73	.336	.344
K DIA	15.65	15.85	.616	.624
L DIA	3.01	3.05	.118	.120

INTERFACE N 18 GHz

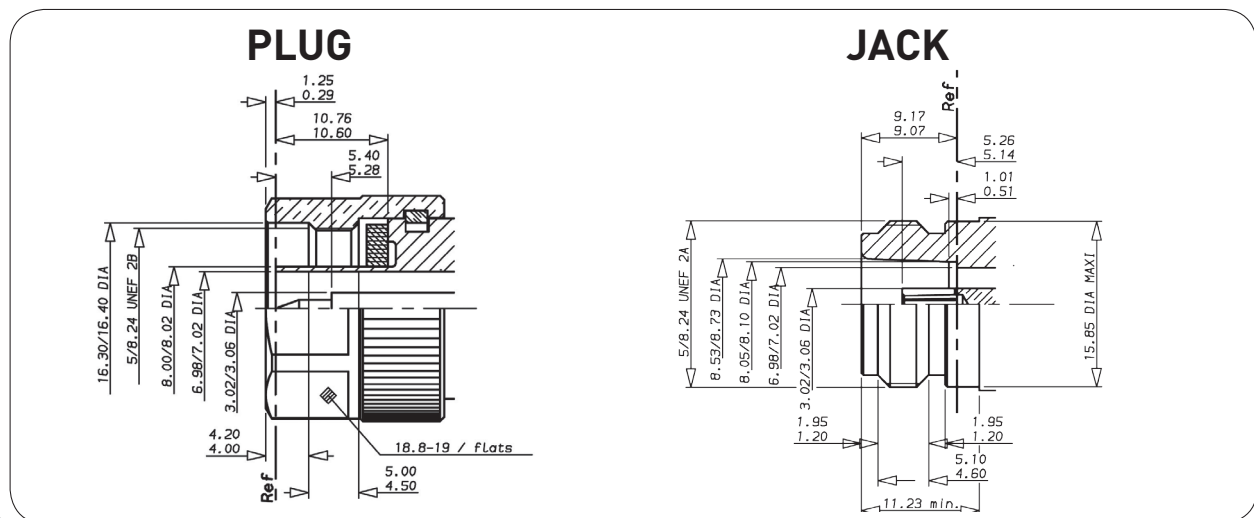

IMPORTANT: the 50Ω and the 75Ω connectors are NOT INTERMATEABLE, resulting in the interface destruction.

INTERFACE N 18 GHz

N 18 GHz/N 75Ω

LETTER	mm	inch
	0.29	.0114
	1.25	.049
	3.02	.1189
	3.06	.1204
	4.00	.157
	4.20	.165
	4.50	.177
	5.00	.197
	5.28	.208
	5.40	.2126
	6.98	.2748
	7.02	.2764
	8.00	.315
	8.02	.316
	10.60	.417
	10.76	.423
	16.30	.642
	16.40	.646
	18.80	.740
	19.00	.748

LETTER	mm	inch
	0.51	.020
	1.01	.0397
	1.20	.0472
	1.95	.0767
	3.02	.1189
	3.06	.1204
	4.60	.1811
	5.10	.201
	5.14	.202
	5.26	.207
	6.98	.2748
	7.02	.2764
	8.05	.317
	8.10	.319
	8.53	.336
	8.73	.3437
	9.07	.357
	9.17	.361
	11.23	.442
	15.85	.624

Mating dimensions are MIL-C-39012 nominal with tighter tolerances and solid outer contact.

INTERFACE N 75Ω

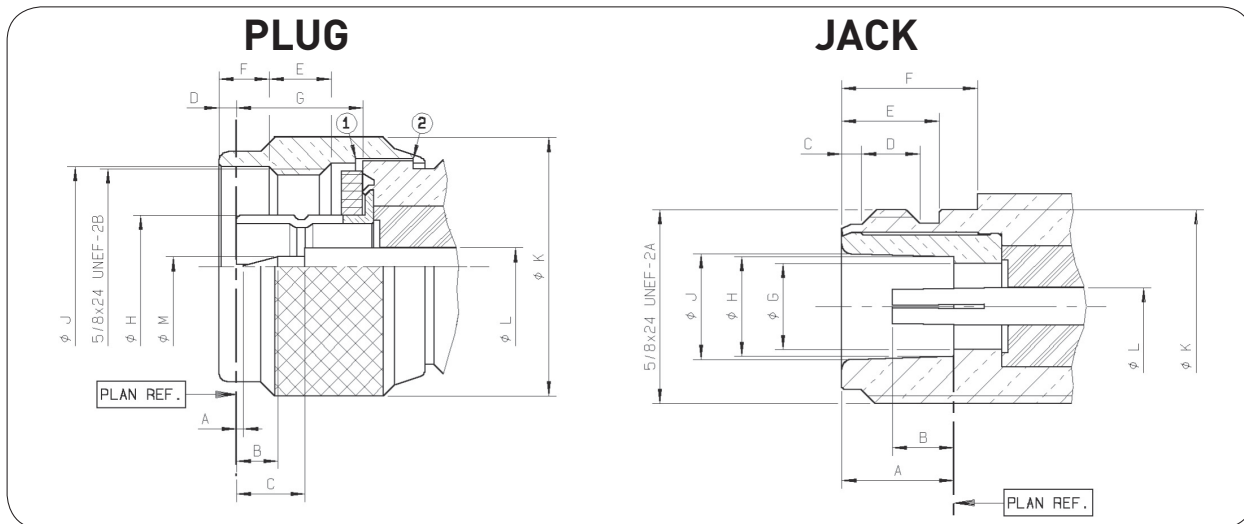

LETTER	mm		inch	
	min.	max.	min.	max.
A	0.13	1.03	.005	.13
B	2.80	3.56	.110	.140
C	5.33	5.83	.210	.230
D	1	2	.016	.066
E	4.54	5.39	.179	.212
F	4.05	4.20	.159	.165
G	10.23	10.43	.403	.411
H DIA	8.27	8.37	.326	.329
J DIA	16.1	16.2	.634	.638
K DIA	20.9	21	.823	.827
L DIA	1.96	2	.077	.079
M DIA	0.87	0.91	.034	.036

LETTER	mm		inch	
	min.	max.	min.	max.
A	9.05	9.19	.356	.362
B	4.75	5.25	.187	.207
C	1.20	1.95	.047	.077
D	4.4	5.1	.173	.201
E	6.8	9	.268	.354
F	10.9	11.2	.429	.441
G DIA	6.98	7.02	.275	.276
H DIA	8.03	8.13	.316	.320
J DIA	8.53	8.73	.336	.344
K DIA	15.65	15.85	.616	.624
L DIA	1.96	2	.077	.079

IMPORTANT: the 50Ω and the 75Ω connectors are NOT INTERMATEABLE, resulting in the interface destruction.

*statistics dimensions: .0539 .0055 (.0594 max)/(1.37 0.14)(1.51 max)

- 1) Coupling nut against on datum 1
- 2) Coupling nut against on datum 2

CHARACTERISTICS

Test/characteristics	Standard reference	Values/remarks
----------------------	--------------------	----------------

ELECTRICAL CHARACTERISTICS

Impedance		50Ω			
Frequency range		DC - 11 GHz			
Typical V.S.W.R.	Frequency	1 GHz	2.5 GHz	5 GHz	11 GHz
straight models cable group:	.085"	1.03	1.03	1.05	1.08
	.141"	1.03	1.05	1.05	1.08
	.250"	1.03	1.03	1.05	1.07
	5/S+5/D	1.05	1.06	1.1	1.16
	10/S+11/D	1.04	1.05	1.09	1.2
	right angle models: 5/S+D	1.04	1.05	1.18	
	10/S+11/D	1.04	1.1	1.20	
Intermodulation product (IMP ₃)					
<ul style="list-style-type: none"> Standard connectors Intermodulation connectors Home made intermodulation cable assemblies 		- 90 dBm typ. (- 133 dBc typ. / 20W) - 110 dBm typ. (- 153 dBc typ. / 20W) - 125 dBm typ. (- 165 dBc typ. / 20W)			
Insertion loss	straight connector	MIL	< 0.15 dB max at 10 GHz ~ < 0.05 vF (GHz)		
	right-angle connector		< 0.15 dB max at 10 GHz ~ < 0.1 vF (GHz)		
RF Leakage		MIL	-90 dB min from 2 to 3 GHz (interface)		
Insulation resistance		MIL	5000 MΩ min		
Contact resistance	center contact	MIL	Initial	After tests	
	outer contact		1 mΩ	1.5 mΩ	
			0.2 mΩ	-	
Working voltage in VRMS		CECC	Cable 5/50: 850 (250)		
at sea level			Cable .085"/.141": 350 (250)		
(at 70, 000 feet)			Cable 10+11/50: 1400 (400)		
			Cable LMR 400/600: 1400 (400)		
			Cable .250": 1400 (400)		
			Cable 5/50: 1500 (350)		
Dielectric withstanding voltage in VRMS		CECC	Cable .085"/.141": 1000 (350)		
at sea level			Cable 10/50: 2500 (600)		
(at 70, 000 feet)			Cable LMR 400/600: 2500 (600)		
			Cable .250": 2500 (600)		
			Cable 5/50: 1500 (350)		
			Cable .085"/.141": 1000 (350)		
RF testing voltage		CECC	1500 VRMS (5 MHz sine wave)		
sea level					

MECHANICAL CHARACTERISTICS

Durability		CECC	500 matings	
Engagement and separation torque		CECC	6.6 Ncm max (.58 Inch-pounds)	
Recommended coupling nut torque			40 to 60 Ncm (manual) 130 Ncm (11.45 inch pounds) (with pliers R 282 202 000) 170 Ncm (14.96 inch pounds) (with torque wrench R 282 303 020)	
Proof torque		CECC	170 Ncm (14.96 inch pounds)	
Coupling nut retention force		CECC	450 N (101.25 Lbs)	
Cable retention force		CECC	Cable 5/50/S 150 N (33.75 Lbs)	
			Cable 5/50/D 200 N (48 Lbs)	
			Cable 10/50 300 N (67.5 Lbs)	
			Cable 11/50 400 N (90 Lbs)	
			Cable .141" 270 N (60.75 Lbs)	
Center contact retention force	axial	MIL	27 N (6.08 Lbs) cables < ∅ 8 mm 68 N (15.30 Lbs) cables > ∅ 8 mm	

Standard packaging = 50 pieces.

CHARACTERISTICS

N 50Ω/ECO N

Test/characteristics	Standard reference	Values/remarks
----------------------	--------------------	----------------

ENVIRONMENTAL CHARACTERISTICS

Temperature range	standard models semi-rigid cables	CECC	- 55°C + 155°C - 55°C + 105°C
Thermo cycling test		CECC	- 55°C/+ 155°C/21 j
Thermal shock		CECC	- 40°C/+ 155°C or - 40°C/+ 85°C - 5 cycles
High temperature test		CECC	125°C/1000 H
Corrosion salt spray		CECC	48 H
Vibration		CECC	Sinus 10g/10 - 500 Hz
Shock		CECC	1/2 Sinus 50g/11 ms
Moisture resistance	clamp type crimp type	IEC 529	IP 67 IP 65 (with heatshrink sleeve)
Hermetic test		CECC	10 ⁻⁵ bar. cm ³ /s
Leakage		CECC	Differential pressure 100 to 110 KPa: 1 bar cm ³ / H

MATERIALS

Body / nut / center male contact / outer contact	Brass
Center female contact	Treated beryllium copper
Ferrule	Brass
Insulator	PTFE
Gasket	Silicon elastomer

PLATING

	Standard	Intermodulation models + COAXI-KIT
Body	BBR	Silver + BBR
crimp + clamp type solder type	Gold	Silver
Coupling nut/Design	BBR/cross knurled	BBR/hex.
Center contacts	Gold	Silver
Outer contacts/Design	BBR/slotted	Silver + BBR/non slotted

CHARACTERISTICS ECO N

ELECTRICAL AND MECHANICAL CHARACTERISTICS

Impedance	50Ω
Frequency range	DC - 6 GHz
Typical VSWR (straight models)	1.2 at 6 GHz
Temperature range	- 40°C/+ 85°C
Durability	100 mating cycles

MATERIALS AND PLATING

Component	Materials	Platings
Connector body	Brass	BBR
Insulator	PTFE / Polypropylene	
Female center contact	Bronze	Center contact Gold 0.1 μm (typical)
Outer contact	Brass	BBR

PACKAGING

Packaging / MOQ ⁽¹⁾	50 pieces bulk / MOQ 1000 pieces Unit packaging / MOQ 100 pieces
--------------------------------	---

⁽¹⁾ MOQ = Minimum Order Quantity

Some connectors may feature different performances depending on the application they have been designed for, or according to the applicable cable.

CHARACTERISTICS

Test/characteristics	Values/remarks
----------------------	----------------

ELECTRICAL CHARACTERISTICS

Impedance	50Ω	
Frequency range	DC - 18 GHz	
Typical V.S.W.R. straight connector right angle connector	With SHF cables 1.10 at 18 GHz 1.15 at 18 GHz	
Insertion loss	< 0.1 √F (GHz) dB	
RF Leakage	- 90 dB (2 to 3 GHz)	
Insulation resistance	5000 MΩ min	
Contact resistance outer contact inner contact	After environment test 2 mΩ max N.A.	Initial 1.5 mΩ max 2 mΩ max
Peak power (at sea level)	5000 W	
Average power (at sea level, 25°C)	2000 W at 0.1 GHz 600 W at 1 GHz 150 W at 10 GHz	
	.085" semi-rigid cable	.141" semi-rigid cable
Dielectric withstanding voltage at sea level at 70 000 feet	1000 Vrms 250 Vrms	1500 Vrms 375 Vrms
Voltage rating at sea level at 70 000 feet	335 Vrms 85 Vrms	500 Vrms 125 Vrms
RF high potential withstanding voltage	670 Vrms	1000 Vrms
Corona level	250 Vrms	375 Vrms

MECHANICAL CHARACTERISTICS

Durability	500 matings	
Cable retention force	136 N (31 lbf)	272 N (61 lbf)
Recommended coupling torque	160 Ncm (14 lbf.in)	
Contact captivation	27 Ncm (6 lbf) min	

ENVIRONMENTAL CHARACTERISTICS

Temperature range	Standard connectors - 65°C + 165°C	Connectors for semi-rigid cable - 40°C + 125°C
Vibration	MIL-STD-1344 Method 2005 Condition 4	
Shock	MIL-STD-1344 Method 2004 Condition G	
Thermal shock	MIL-STD-1344 Method 1003 Condition A	
Corrosion (salt mist)	MIL-STD-1344 Method 1001 Condition B	
High temperature test	CECC 22000/4.7.2	
Damp heat	CECC 22000/4.6.6	
Low pressure immersion	EN2591 AECMA TestC14	
Resistance to fluids contamination	EN2591 AECMA TestC15	

MATERIALS

Body	Stainless steel
Center contact	Beryllium copper and brass
Coupling nut	Brass
Insulator	PTFE or polyetherimid resin
Gasket	Fluorosilicon or fluorocarbon

PLATING

Body	Passivated
Center contact	Gold
Coupling nut	Nickel

Test/characteristics	Standard reference	Values/remarks
----------------------	--------------------	----------------

ELECTRICAL CHARACTERISTICS

Impedance		75Ω
Frequency range		DC - 1.5 GHz
Typical V.S.W.R.	Cable 6/75 Cable 10+11/75	1.06 1.10
Insertion loss	straight connector right-angle connector	MIL < 0.15 dB
RF Leakage	MIL	- 90 dB min at 1 GHz
Insulation resistance	MIL	5000 MΩ min
Contact resistance	center contact outer contact	MIL Initial 1 mΩ 0.2 mΩ After tests 1.5 mΩ -
Working voltage in VRMS at sea level (at 70 000 feet)	CECC	Cable 10+11/75: 1400 (400) Cable 6/75: 850 (250)
Dielectric withstanding voltage in VRMS at sea level (at 70 000 feet)	CECC	Cable 10+11/75: 2500 (600) Cable 6/75: 1500 (350)
RF testing voltage sea level	CECC	1500 VRMS (5 MHz sine wave)

MECHANICAL CHARACTERISTICS

Durability	CECC	500 matings
Engagement and separation torque	CECC	6.6 Ncm max (.58 Inch-pounds)
Recommended coupling nut torque	CECC	40 to 60 Ncm (manual) 130 Ncm (11.45 inch pounds) (with pliers R282 202 000)
Proof torque	CECC	170 Ncm (14.96 inch pounds)
Coupling nut retention force	CECC	450 N (101.25 Lbs)
Cable retention force	cable 6/75 cable 10+11/75	CECC 200 N 300 N
Center contact retention force axial	MIL	27 N (6.08 Lbs)

ENVIRONMENTAL CHARACTERISTICS

Temperature range	CECC	- 55°C + 155°C
Thermo cycling test	CECC	- 55°C / + 155°C / 21 j
Thermal shock	CECC	- 40°C / + 155°C or - 40°C / + 85°C - 5 cycles
High temperature test	CECC	125°C / 1000 H
Corrosion salt spray	CECC	48 H
Vibration	CECC	Sinus 10 g / 10 - 500 Hz
Shock	CECC	1/2 Sinus 50g / 11 ms
Moisture resistance clamp type crimp type	IEC 529	IP 67 IP 65 (with heatshrink sleeve)
Hermetic test	CECC	10-5 bar. cm ³ /s
Leakage	CECC	Differential pressure 100 to 110 KPa: 1 bar cm ³ / H

MATERIALS

Body (nut)/center male contact/outer contact	Brass
Center female contact	Treated beryllium copper
Ferrule	Brass
Insulator	PTFE
Gasket	Silicon elastomer

PLATING

Body	BBR
Coupling nut/design	BBR/cross knurled
Center contact	Gold
Outer contact/design	BBR/slotted

Standard packaging = 50 pieces.

PLUGS

STRAIGHT PLUGS, FULL CRIMP TYPE, FOR FLEXIBLE CABLES

(single piece body)

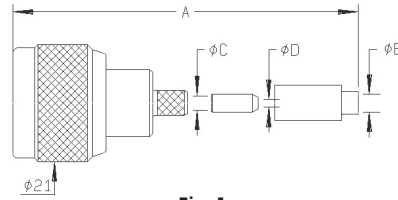

Fig. 1

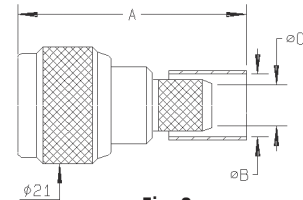

Fig. 2

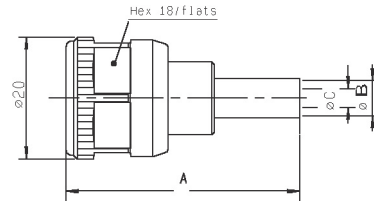

Fig. 3

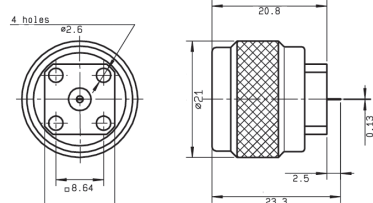

Fig. 4

Cable group	Cable group dia.	Part number	Fig.	Dimensions (mm)				Captive center contact	Note
				A	B dia.	C dia.	D dia.		
RG174/RG316/RD316	2.6/50/S+D	R161 072 000	1	39.7	3.25	3.38	1.63	yes	
RG58/R141	5/50/S	R161 082 000	2	38.5	5.41	3.11		yes	
		R161A 082 000						yes	ECO version
RG142/RG223/RG400	5/50/D	R161 083 000	2	30.5	5.8	3.11		yes	
		R161A 083 000						yes	ECO version
	8.07/50	R161 083 137	3	38.5				yes	For intermodulation application tool
		R161 092 190	4						
RG213	10/50/S	R161 075 000	2	40.2	11.05	7.46		yes	
		R161A 075 000		37.2	11.05			ECO version	
	10.3/50/S	R161 075 060		40.2	11.05			yes	LMR 400 cable
RG214	11/50/D	R161 088 000		40.2	11.4			yes	
		R161A 088 000		37	11.4				ECO version

STRAIGHT PLUGS, CLAMP TYPE, FOR FLEXIBLE CABLES

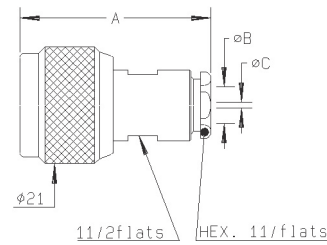
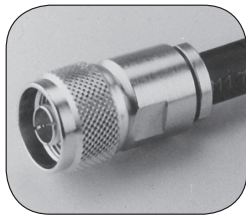

Fig. 1

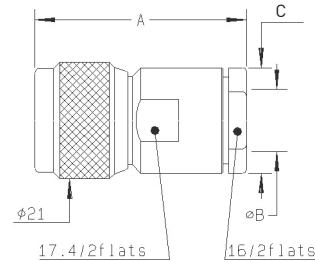
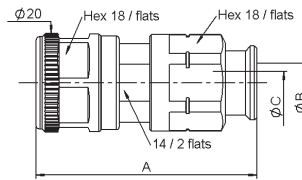

Fig. 2

Cable group	Cable group dia.	Part number	Fig.	Dimensions (mm)			Captive center contact
				A	B dia.	C dia.	
RG174/RG316/RD316	2.6/50/S+D	R161 004 000	1	33.9	3.1	1.7	yes
RG58/RG141/RG142/RG223/RG400	5/50/S+D	R161 006 000		34.4	5.6		no
		R161 008 000					yes
		R161 010 000		34.9	5.6		yes
RG59/RG62/RG71	6/75+93	R161 012 000		34.4	6.6		
RG213/RG393/RG11/RG12/RG144/RG214/RG216	10+11/50+75	R161 018 000	2	44	11.2	17.5	
		R161 020 000		38.1	11.2	17.5	no
		R161 022 000		38.9	11.2	19	yes
RG217	14/50/D	R161 027 000		40.9	14.4	22.2	
RG218	22/50/S	R161 030 000W		56.6	22.9	33.6	

STRAIGHT PLUGS, EZ FIT TYPE, FOR CORRUGATED CABLES



Cable group dia.	Part number	Dimensions (mm)			Captive center contact
		A	B dia.	C dia.	
1/2" superflexible corrugated	R161 037 020	45.1	14	8.8	yes

STRAIGHT PLUGS, FOR SEMI-RIGID CABLES

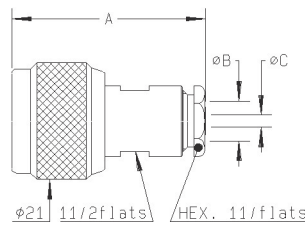
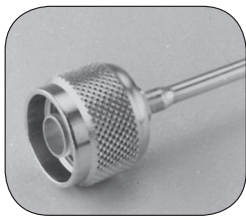

Fig. 1

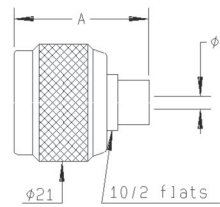

Fig. 2

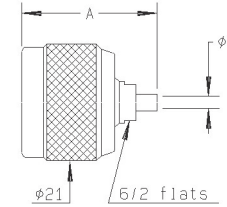

Fig. 3

Cable group	Cable group dia.	Part number	Fig.	Dimensions (mm)			Captive center contact	Note
				A	B dia.	C dia.		
RG405	.085"	R161 050 300	3	24.4	2.25			Solder type
RG402	.141"	R161 051 000	1	35	5.6	3.65	no	Solder type
		R161 052 000						Clamp type
RG401	.250"	R161 053 000	2	24.4	6.45			Clamp type
		R161 054 000				Solder type		

RIGHT ANGLE PLUGS, CRIMP TYPE, FOR FLEXIBLE CABLES

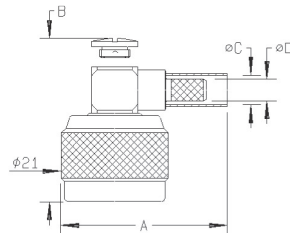
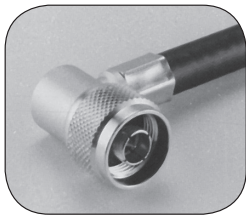

Fig. 1

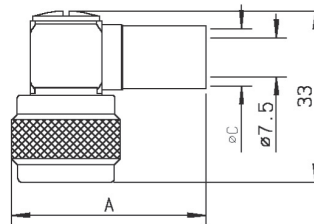

Fig. 2

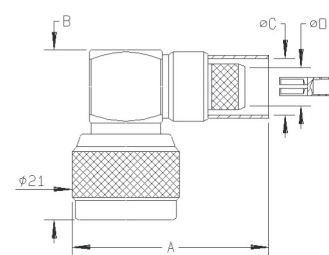

Fig. 3

Cable group	Cable group dia.	Part number	Fig.	Dimensions (mm)				Captive center contact	Note
				A	B	C dia.	D dia.		
RG174/RG316	2.6/50/S	R161 181 000	1	29.5	26.3				
RG58/RG141	5/50/S	R161 182 000		28	5.41			yes	
		R161A 182 000	28.5		3.1		ECO version		
RG142/RG223/RG400	5/50/D	R161 183 000	1	34.5	28	5.8	3.1	yes	
		R161A 183 000						yes	ECO version
RG223	10/50/S	R161 194 190	3	61	34	8.4	6.3		
		R161A 184 000	1	32.8	35.2		7.4	ECO version	
RG214	10.3/50/S	R161 185 000	3	42.4	33.2	11.05	7.46	yes	Full crimp
		R161 184 036	2	46.25		11.05		yes	LMR 400 cable
RG214	11/50/D	R161 186 000		2	37.6		11.4		yes
		R161A 186 000	33					ECO version	
		R161 187 000	3	42.4	33.2	11.4	7.46	yes	Full crimp

To download data sheets and assembly instructions, visit www.radiall.com & enter the part number in the Search box. **Bold** part numbers represent products typically in stock & available for immediate shipment. See page 8 and 9 for packaging information.

PLUGS AND JACKS

RIGHT ANGLE PLUGS, CLAMP TYPE, FOR FLEXIBLE CABLES

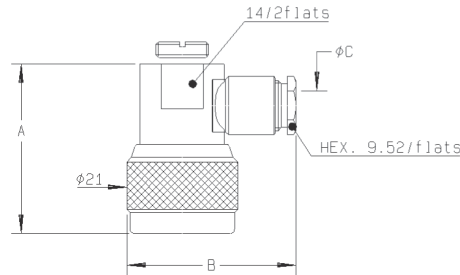
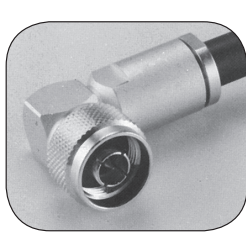

Fig. 1

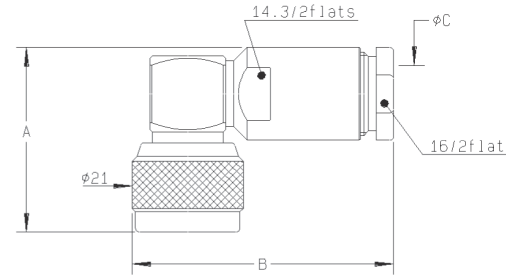
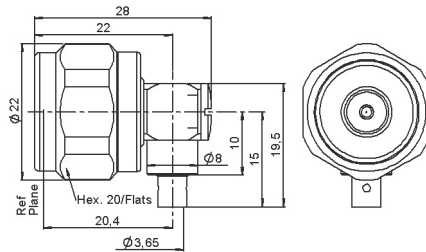

Fig. 2

Cable group	Cable group dia.	Part number	Fig.	Dimensions (mm)			Captive center contact
				A	B	C dia.	
RG223/RG142/RG223/RG400	5/50/S+D	R161 156 000	2	34.85	49.4	11.2	yes
		R161 157 000	1	32	32	5.6	
RG213/RG393/RG214	10+11/50/S+D	R161 168 000	2	34.85	49.4	11.2	yes

RIGHT ANGLE PLUG, SOLDER TYPE, FOR SEMI-RIGID CABLES



Cable group	Cable group dia.	Part number	Captive center contact
RG402	.141"	R161 152 107	yes

STRAIGHT JACKS, FULL CRIMP TYPE, FOR FLEXIBLE CABLES

(single piece body)

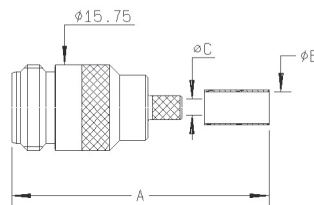
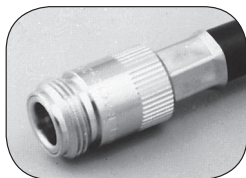

Fig. 1

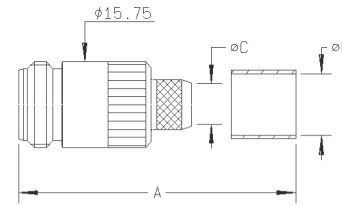

Fig. 2

Cable group	Cable group dia.	Part number	Fig.	Dimensions (mm)			Captive center contact
				A	B dia.	C dia.	
RG58/RG141	5/50/S	R161 237 000	1	39.3	5.41	3.11	yes
RG142/RG223/RG400	5/50/D	R161 238 000			5.8		
RG223	10/50/S	R161 241 000	2	40.6	11.05	7.46	
RG214	11/50/D	R161 243 000			11.4		

STRAIGHT JACKS, CLAMP TYPE, FOR FLEXIBLE CABLES

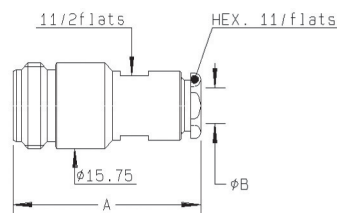

Fig. 1

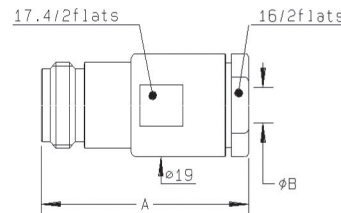

Fig. 2

Cable group	Cable group dia.	Part number	Fig.	Dimensions (mm)		Captive center contact
				A	B dia.	
RG223/RG142/RG223/RG400	5/50/S+D	R161 206 000	1	35.3	5.6	yes
RG213/RG393/RG214	10+11/50/S+D	R161 220 000	2	39.3	11.2	yes

STRAIGHT JACKS

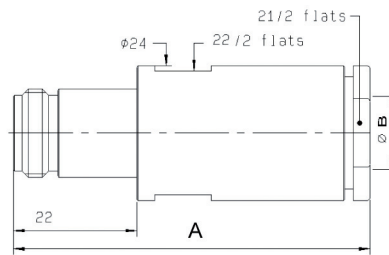

Fig. 1

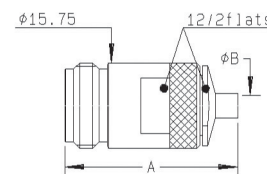
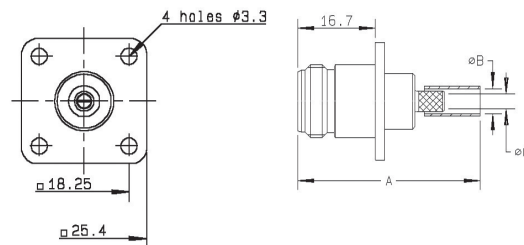
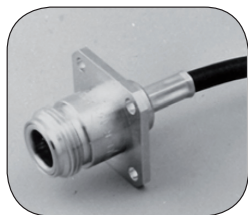

Fig. 2

Cable group	Cable group dia.	Part number	Fig.	Dimensions (mm)		Captive center contact	Note
				A	B dia.		
	1/2" superflexible corrugated	R161 232 407	1	66	14	yes	EZ fit type
RG402	.141"	R161 226 020	2	32	3.65	no	Solder type

SQUARE FLANGE, STRAIGHT JACKS, FULL CRIMP TYPE, FOR FLEXIBLE CABLES (single piece body)



Cable group	Cable group dia.	Part number	Dimensions (mm)			Captive center contact	Panel drilling
			A	B dia.	C dia.		
RG174/RG316/RD176	2.6/50/S+D	R161 281 300	40.3	3.25	1.63		P01
RG58/RG141	5/50/S	R161 282 000	39.3	5.41			
RG142/RG223/RG400/RG213	5/50/D	R161 283 000	39.3	5.8	3.11	yes	
	8.07/50	R161 292 190	50.4	8.4	6.3		
RG213	10/50/S	R161 286 000	40.6	11.05	7.46	yes	

To download data sheets and assembly instructions, visit www.radiall.com & enter the part number in the Search box. **Bold** part numbers represent products typically in stock & available for immediate shipment. See page 8 and 9 for packaging information.

SQUARE FLANGE, STRAIGHT JACKS

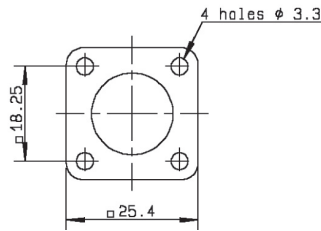
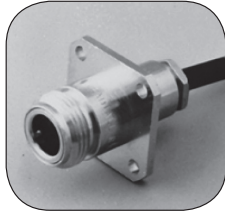

Fig. 1 and 2

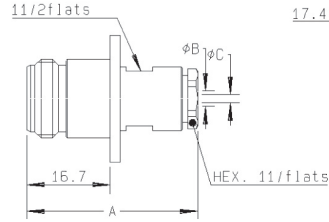

Fig. 1

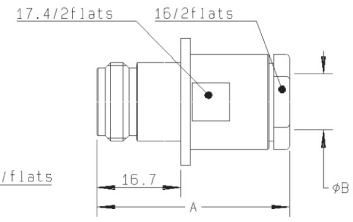

Fig. 2

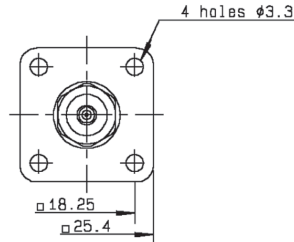

Fig. 3 and 4

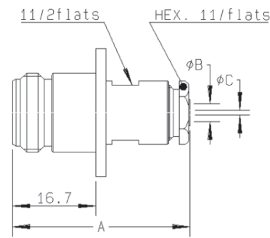

Fig. 3

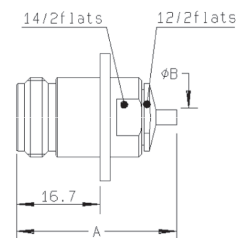

Fig. 4

Cable group	Cable group dia.	Part number	Fig.	Dimensions (mm)			Captive center contact	Panel drilling	Note
				A	B dia.	C dia.			
RG174/RG316/RD316	2.6/50/S + D	R161 252 000	1	34.3	3.1	1.7	yes	P01	Clamp type
RG58/RG141/RG142/RG223/RG400	5/50/S + D	R161 256 000		35.4	5.6				
RG213/RG393/RG214	10 + 11/50/S + D	R161 270 000	2	39.3	11.2		no	P01	Clamp type
RG402	.141"	R161 277 000	3	35.5	5.6	3.65			Solder type
RG401	.250"	R161 278 000	3	35.9	6.6				Clamp type

BULKHEAD STRAIGHT JACKS, FULL CRIMP TYPE, FOR FLEXIBLE CABLES (panel sealed) (single piece body)

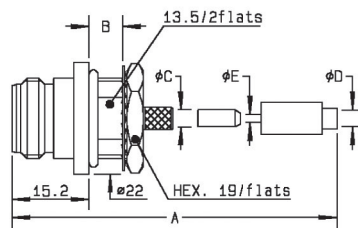

Fig. 1

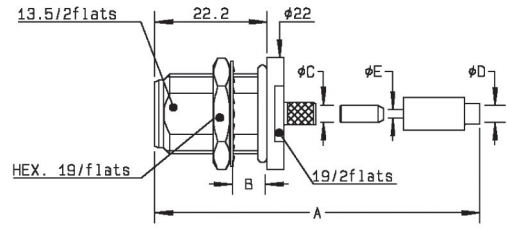

Fig. 2

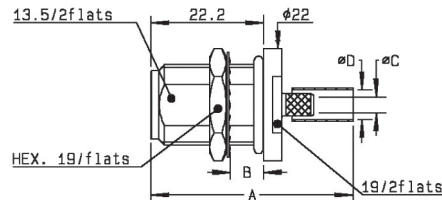

Fig. 3

Cable group	Cable group dia.	Part number	Fig.	Dimensions (mm)					Captive center contact	Panel drilling	Note
				A	B	C dia.	D dia.	E dia.			
RG174/RG316/RD316	2.6/50/S+D	R161 311 200	1	40.4	6.5	3.38	3.25	1.63	yes	P14	Front mount
		R161 311 300	2								Rear mount
RG58/RG141	5/50/S	R161 329 000	3	39.8	6.5	3.11	5.41				
RG142/RG223/RG400	5/50/D	R161 329 200					5.8				

BULKHEAD STRAIGHT JACKS, CLAMP TYPE, FOR FLEXIBLE CABLES (panel sealed)

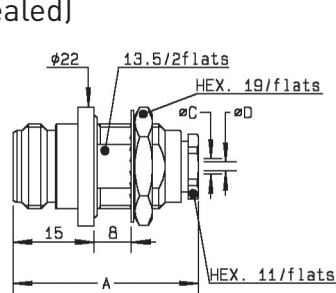
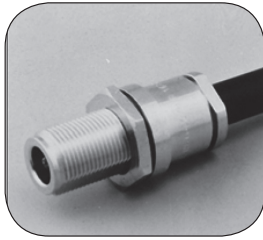

Fig. 1

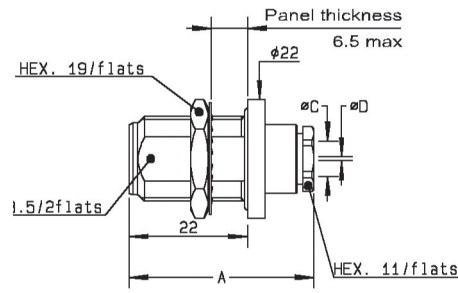

Fig. 2

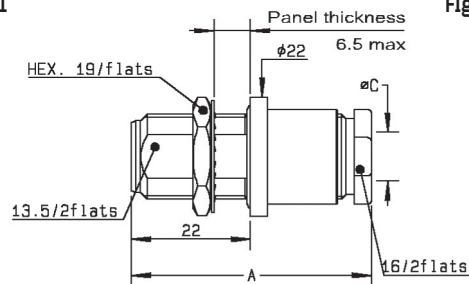

Fig. 3

Cable group	Cable group dia.	Part number	Fig.	Dimensions (mm)			Captive center contact	Panel drilling	Note
				A	C dia	D dia			
RG174/RG316/RD316	2.6/50/S+D	R161 321 000	1	34.3	3.1	1.7	yes	P14	Front mount
		R161 322 000	2						Rear mount
RG58/RG141/RG142/RG223/RG400	5/50/S+D	R161 325 000	2	35.4	5.6				Rear mount
RG213/RG393/RG214	10+11/50/S+D	R161 332 000	3	43	11.2	no			

BULKHEAD STRAIGHT JACKS, FOR SEMI-RIGID CABLES (panel sealed)

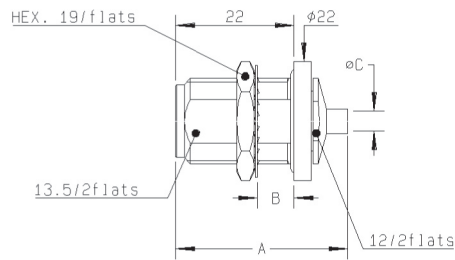

Fig. 1

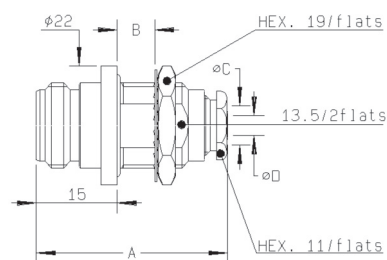

Fig. 2

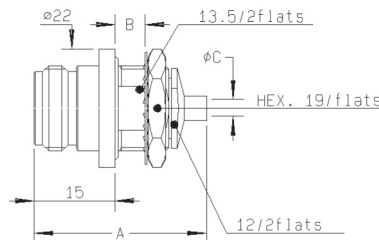

Fig. 3

Cable group	Cable group dia.	Part number	Fig.	Dimensions (mm)				Captive center contact	Panel drilling	Note
				A	B	C dia	D dia			
RG405	.085"	R161 335 200	1	32	6.5	2.25		no	P14	Solder type/Rear mount
RG402	.141"	R161 323 000	2	35.5	8	5.6	3.65			Clamp type/Front mount
		R161 336 000	1	32	6.5	3.65	Solder type/Rear mount			
		R161 336 200	3				Solder type/Front mount			
RG401	.250"	R161 337 200	1			6.6		Solder type/Rear mount		

To download data sheets and assembly instructions, visit www.radiall.com & enter the part number in the Search box. **Bold** part numbers represent products typically in stock & available for immediate shipment. See page 8 and 9 for packaging information.

RECEPTACLES

LOW PROFILE SQUARE FLANGE, STRAIGHT FEMALE RECEPTACLES

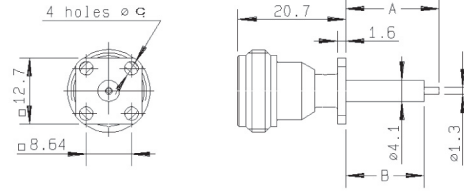

Part number	Dimensions (mm)			Captive center contact	Panel drilling	Note
	A	B	C dia			
R161 410 520	17.9	15	2.9	yes	P11	Extended dielectric

FLANGE, STRAIGHT FEMALE RECEPTACLES

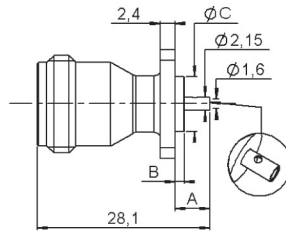

Fig. 1

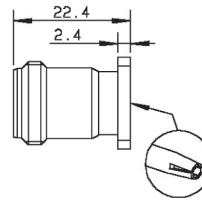

Fig. 2

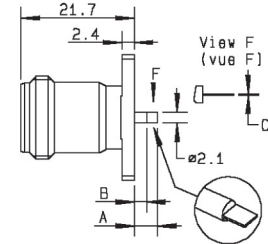

Fig. 3

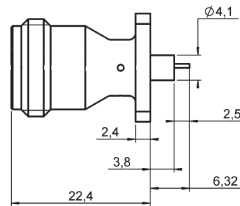

Fig. 4

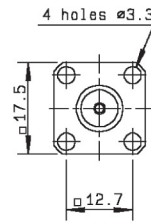

Fig. A

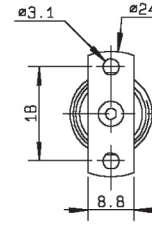

Fig. B

Part number	Fig.	Dimensions (mm)			Captive center contact	Panel drilling	Note
		A	B	C			
R161 410 000	1 + A	5.7	1.5	8.9	yes	P03	ECO version
R161A 410 000							
R161 410 130	4 + A	6.32	3.8	0.64		P16	Solder pot contact
R161 418 000	2 + A				yes	P03	Universal/see contacts page 12-22
R161 461 000	3 + B	6.2	3.9	0.6	yes	P12	2 hole flange/flat tab contact

STRAIGHT MALE AND FEMALE RECEPTACLES

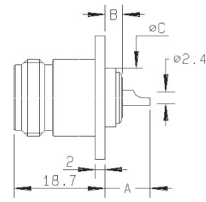
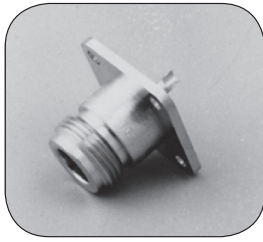

Fig. 1

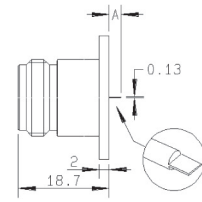

Fig. 2

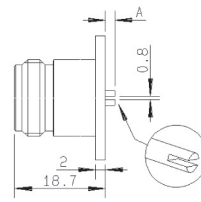

Fig. 3

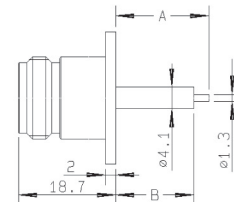

Fig. 4

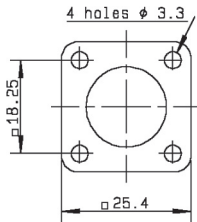

Fig. A

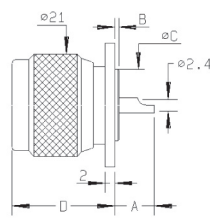

Fig. 5

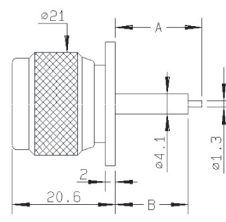

Fig. 6

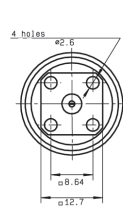
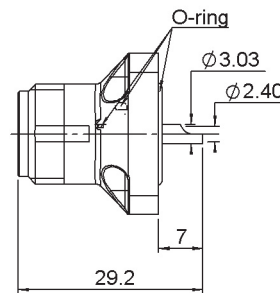
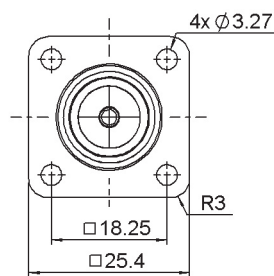

Fig. 7

Part number	Fig.	Dimensions (mm)				Captive center contact	Panel drilling	Note
		A	B	C dia	D			
R161 404 000	1 + A	9.3	0.8	14.6		yes	P07	Solder pot
R161A 404 000								Solder pot/ECO version
R161 404 137								For intermodulation application/ Center contact brass
R161 416 130	4 + A	17.9	15		P09		Extended dielectric	
R161 419 020	2 + A	2.5			P10		Flat tab contact	
R161 419 300	3 + A	2			P01		Slotted contact	
R161 430 020	1 + A	6.5			P10		Short back length	
R161 441 000	5 + A	8.7	0.8	14.6	20.6		P02	Male/solder pot
R161 441 400	6 + A	17.9	15				P06	Male/extended dielectric
R161 438 200	7						P11	

COMPOSITE FEMALE RECEPTACLES



Part number	Captive center contact	Description	Color	Packaging
R161 404 C01	yes	-	Black	50 pieces
R161 404 C02		Combination seal		
R161 404 C03		Panel seal		

Standard color is black however, other colors are proposed upon request.
Other specific demands can be proceeded according to customer needs.

To download data sheets and assembly instructions, visit www.radiall.com & enter the part number in the Search box.
Bold part numbers represent products typically in stock & available for immediate shipment.
See page 8 and 9 for packaging information.

RECEPTACLES

RIGHT ANGLE FEMALE RECEPTACLES

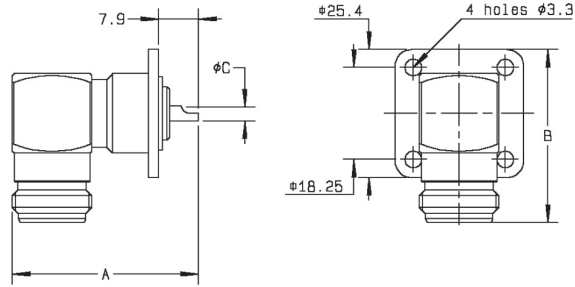

Part number	Dimensions (mm)			Captive center contact	Panel drilling	Note
	A	B	C dia			
R161 653 000	36.9	34.4	2.5	yes	P02	Solder pot

BULKHEAD STRAIGHT RECEPTACLES (fully sealed or panel hermetic)

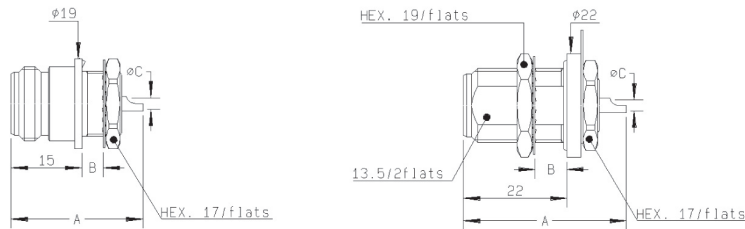

Fig. 1

Fig. 2

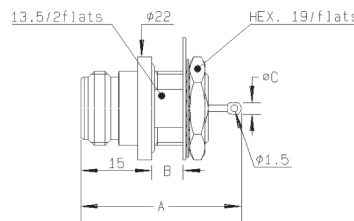

Fig. 3

Part number	Fig.	Dimensions (mm)			Captive center contact	Panel drilling	Note
		A	B	C			
R161 570 000	1	28	4.5	2.4	yes	P13	Front mount
R161 606 000	2	34.6	6.5	2.4		P14	Rear mount/fully sealed
R161A 606 010						P14	Rear mount/fully sealed/ECO version
R161 625 000	3	34	6.5	2.5	P14	Front mount/Panel hermetic	

N SMT SWITCH AND RECEPTACLE

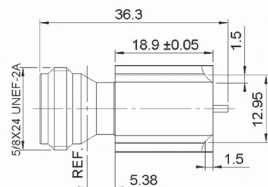

Fig. 1

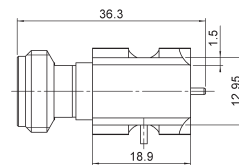

Fig. 2

Part number	Fig.	Note
R161 427 223	1	Edge card female receptacle
R161 428 223	2	Edge card SMT left type switch
R161 428 233		Edge card SMT right type switch

IN SERIES ADAPTERS

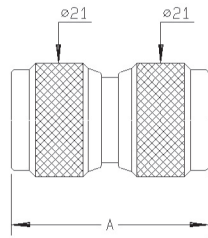

Fig. 1

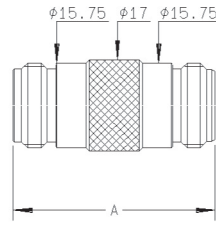

Fig. 2

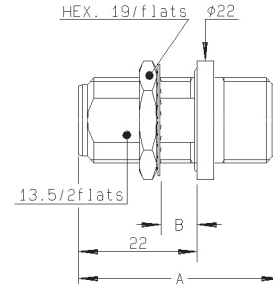

Fig. 4

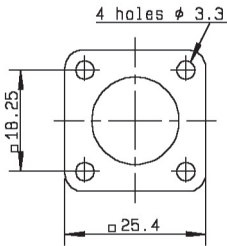

Fig. 3

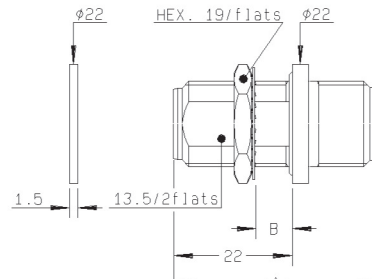
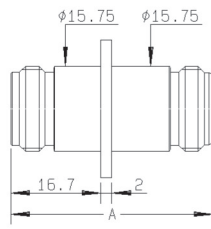

Fig. 5

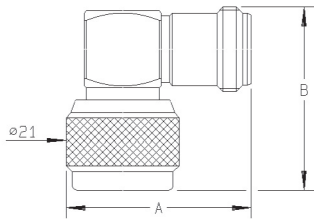

Fig. 6

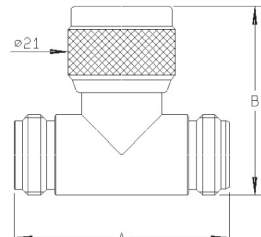

Fig. 7

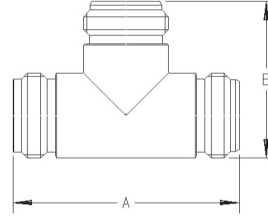

Fig. 8

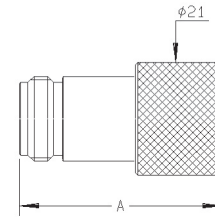

Fig. 9

Part number	Fig.	Dimensions (mm)		Panel drilling	Note
		A	B		
R161 703 000	1	36.7			Male-Male
R161 705 000	2				Female-Female
R161 715 000	3	37.5		P01	Female-Female/Flange
R161 730 000	4		6.5	P14	Female-Female/Bulkhead panel sealed
R161 753 000	5	38	6.5	P14	Female-Female/Hermetic/bulkhead
R161 771 000	6	34.4	34		Male-Female/Right-angle
R161 780 000	7	42	36.9		TEE Female-Female/Male
R161 782 000	8		29.1		TEE Female-Female/Female
R161 791 500	9	37.37			Push-on Male/Female screwing

To download data sheets and assembly instructions, visit www.radiall.com & enter the part number in the Search box. **Bold** part numbers represent products typically in stock & available for immediate shipment. See page 8 and 9 for packaging information.

CAPS AND ACCESSORIES

PROTECTIVE CAPS

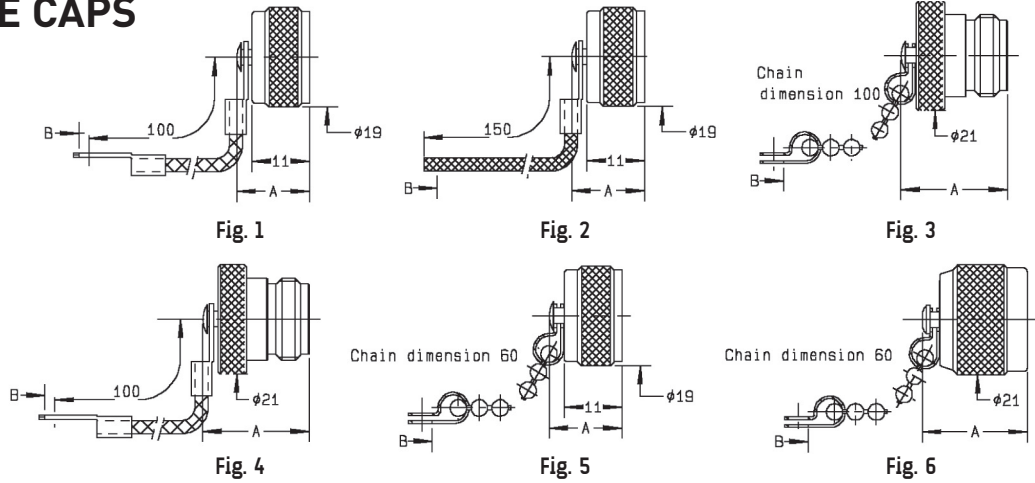

Part number	Fig.	Dimensions (mm)		Note
		A	B	
R161 804 000	1	13.9	3.8	Male with cord
R161 805 410	2	13.9	2	Male with cord
R161 841 000	3	20.4	3.9	Female with chain
R161 844 000	4	20.4	3.8	Female with cord
R161 853 000	5	13.9	3.9	Male with chain
R161 862 000	6	20.1		Male short circuit with chain

FIELD-REPLACEABLE CONTACTS (for universal receptacle)

These accessories have been specifically designed for the adjustment at the rear of hermetically sealed universal receptacles. The choice of their dimensions depends on the PCB or on the thickness of the MIC box. Moreover these contacts and insulators are also compatible with SMA UNIVERSAL RECEPTACLES.

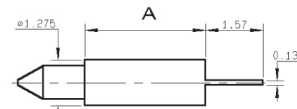
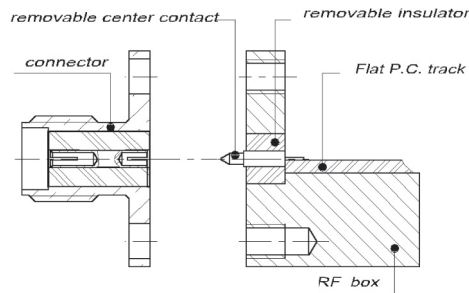

Fig. 1

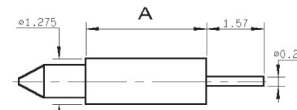
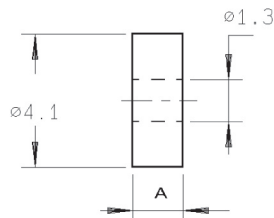

Fig. 2

Part number	Fig.	A	Note	Associated insulator P/N
R280 461 000	1	3.37	Flat tab	R280 468 000
R280 463 000	2		Cylindrical tab	

FIELD-REPLACEABLE INSULATORS



Part number	A	Packaging
R280 468 000	3.17	10

STRAIGHT PLUGS FOR SEMI-RIGID CABLES

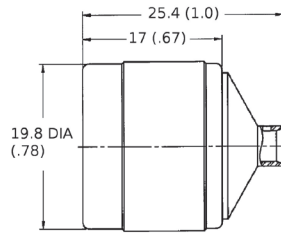

Cable group	Cable group dia.	Part number	Captive center contact	Material	Note
RG405	.085"	4000-1563-009	yes	Stainless steel	Direct solder
RG402	.141"	4000-1563-010			

Note: N18 GHz plugs for SHF high frequency flexible cable are available as cable assemblies only. Consult us for standard N18 GHz cable assembly part numbers.

BULKHEAD STRAIGHT JACKS, FOR SEMI-RIGID CABLES (panel sealed)

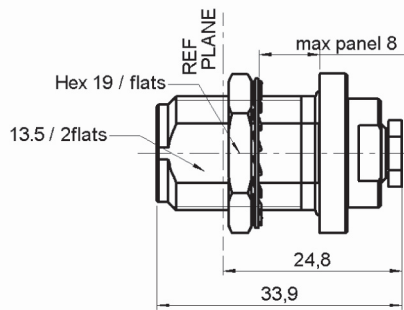
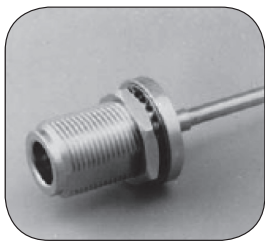

Cable group	Cable group dia.	Part number	Captive center contact	Panel drilling	Material	Note
RG405	.085"	4501-9543-009	yes	P14	Stainless steel	Solder clamp/ rear mount
RG402	.141"	4501-9543-010				
		R163 337 001				

IN SERIES ADAPTERS

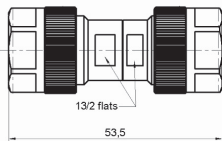

Fig. 1

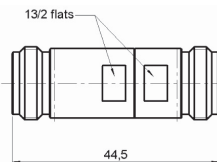

Fig. 2

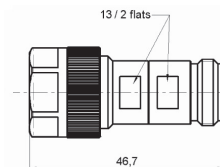

Fig. 3

Part number	Fig.	Dimension (mm)	Note
R163 703 001	1	53.5 (2.106)	Male-Male
R163 705 001	2	44.5 (1.752)	Female-Female
R163 708 001	3	46.7 (1.838)	Male-Female

Note: 7mm air line adapters also available upon request.

To download data sheets and assembly instructions, visit www.radiall.com & enter the part number in the Search box. **Bold** part numbers represent products typically in stock & available for immediate shipment. See page 8 and 9 for packaging information.

PLUGS AND JACKS

STRAIGHT PLUGS, FOR FLEXIBLE CABLES

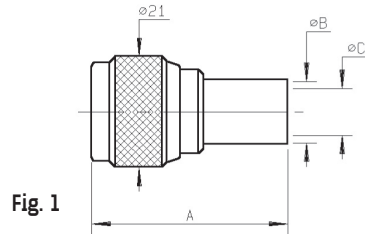

Fig. 1

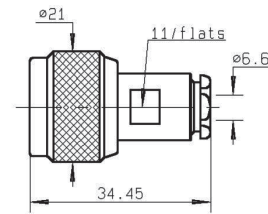

Fig. 2

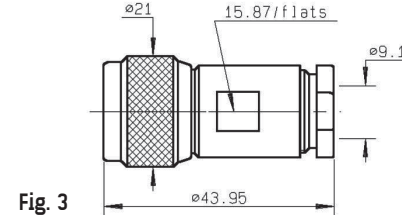

Fig. 3

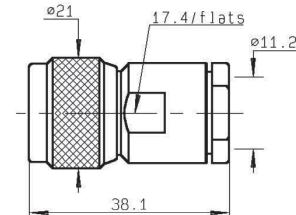

Fig. 4

Cable group	Cable group dia.	Part number	Fig.	Dimensions (mm)			Captive center contact	Note
				A	B dia	C dia		
RG59/RG62	6/75/S	R162 084 000	1	33.9	6.6	4	yes	Crimp type
	6/75+93	R162 012 000	2					
RG6	8/75/D	R162 013 000	3					
RG11/RG12/RG144/RG216	10+11/75	R162 017 000	4				no	Clamp type

STRAIGHT JACKS, CLAMP TYPE, FOR FLEXIBLE CABLES

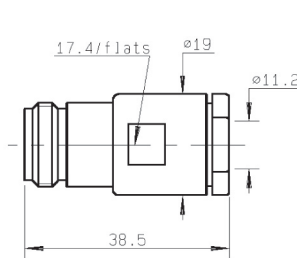
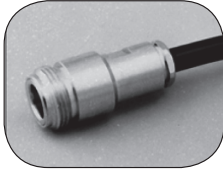

Fig. 1

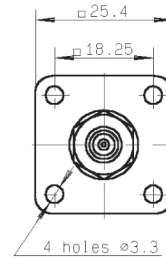
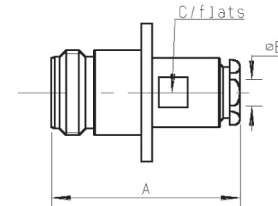
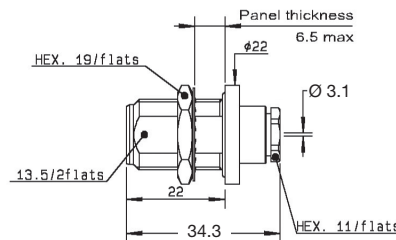

Fig. 2



Cable group	Cable group dia.	Part number	Fig.	Dimensions (mm)			Captive center contact	Panel drilling	Note
				A	B	C			
RG11/RG12/RG144/RG216	10+11/75	R162 217 000	1						
RG59/RG62	6/75+93/S	R162 262 000	2	34.9	6.6	11	no	P01	Square flange

STRAIGHT BULKHEAD JACKS, CLAMP TYPE, FOR FLEXIBLE CABLE (panel seal)



Cable group	Cable group dia.	Part number	Captive center contact	Panel drilling
RG179	2.6/75/S	R162 322 000	no	P14

FEMALE RECEPTACLES

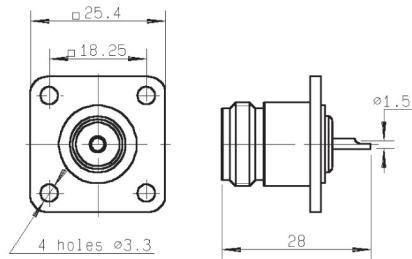

Fig. 1

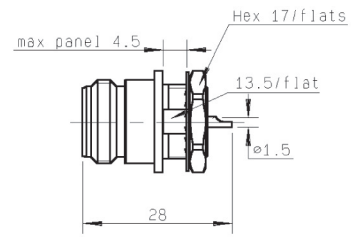

Fig. 2

Part number	Fig.	Captive center contact	Panel drilling
R162 403 000	1	yes	P07
R162 570 000	2		P15

IN SERIES ADAPTERS

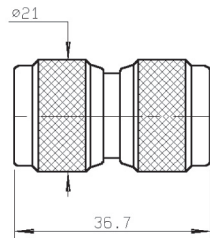

Fig. 1

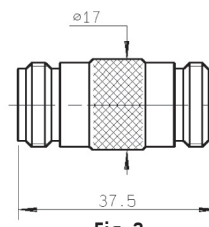

Fig. 2

Part number	Fig.	Captive center contact
R162 703 000	1	yes
R162 705 000	2	

To download data sheets and assembly instructions, visit www.radiall.com & enter the part number in the Search box. **Bold** part numbers represent products typically in stock & available for immediate shipment. See page 8 and 9 for packaging information.

PANEL DRILLING

P01

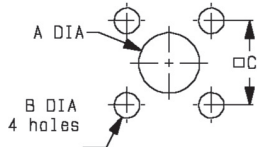

	MM		INCH	
	maxi	mini	maxi	mini
A	16.3	16.1	0.642	0.634
B	3.30	3.20	0.13	0.126
C	18.35	18.15	0.722	0.715

P02

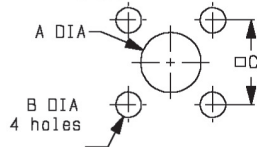

	MM		INCH	
	maxi	mini	maxi	mini
A	15.1	14.9	0.594	0.587
B	3.30	3.20	0.13	0.126
C	18.35	18.15	0.722	0.715

P03

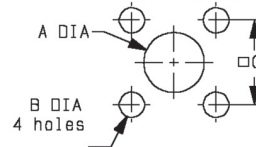

	MM		INCH	
	maxi	mini	maxi	mini
A	9.40	9.20	0.37	0.362
B	3.30	3.20	0.13	0.126
C	12.8	12.6	0.504	0.496

P04

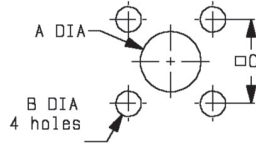

	MM		INCH		
	maxi	mini	maxi	mini	
A	Front	21.7	21.5	0.854	0.846
	Rear	19.7	19.5	0.776	0.768
B	3.30	3.20	0.13	0.126	
C	18.35	18.15	0.722	0.715	

P05

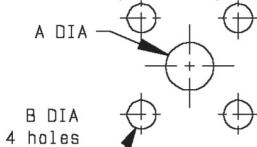

	MM		INCH	
	maxi	mini	maxi	mini
A	7.1	7	0.279	0.275
B	3.4	3.3	0.134	0.13
C	18.35	18.15	0.722	0.715

P06



	MM		INCH	
	maxi	mini	maxi	mini
A	4.2	4.1	0.165	0.161
B	3.3	3.2	0.13	0.126
C	18.35	18.15	0.722	0.715

P07

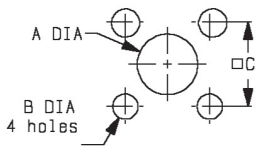

	MM		INCH		
	maxi	mini	maxi	mini	
A	Front	16.3	16.1	0.642	0.634
	Rear	15.1	14.9	0.594	0.587
B	3.30	3.20	0.13	0.126	
C	18.35	18.15	0.722	0.715	

P08

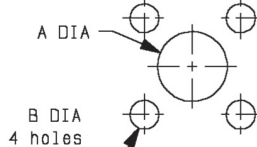

	MM		INCH	
	maxi	mini	maxi	mini
A	12.5	12.3	0.492	0.484
B	3.3	3.2	0.13	0.126
C	18.35	18.15	0.722	0.715

P09

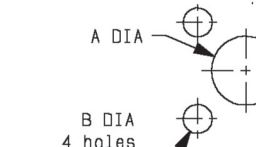

	MM		INCH		
	maxi	mini	maxi	mini	
A	Front	16.3	16.1	0.642	0.634
	Rear	4.2	4.1	.165	0.161
B	3.3	3.2	0.13	0.126	
C	18.35	18.15	0.722	0.715	

P10

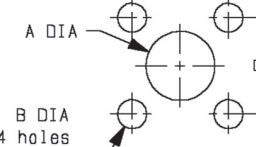

	MM		INCH		
	maxi	mini	maxi	mini	
A	Front	16.3	16.1	0.642	0.634
	Rear	12.5	12.3	0.492	0.484
B	3.3	3.2	0.13	0.126	
C	18.35	18.15	0.722	0.715	

P11

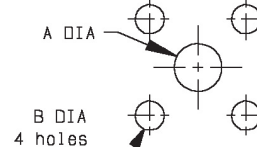

	MM		INCH	
	maxi	mini	maxi	mini
A	4.2	4.1	0.165	0.161
B	2.7	2.6	0.106	0.102
C	8.69	8.59	0.342	0.338

P12

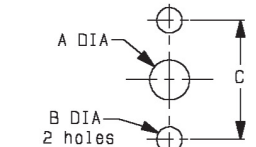

	MM		INCH	
	maxi	mini	maxi	mini
A	5	4.80	0.197	0.189
B	3.30	3.20	0.13	0.126
C	18.1	17.9	0.713	0.705

P13

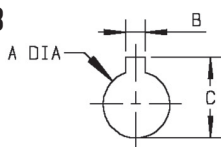

	MM		INCH	
	maxi	mini	maxi	mini
A	14.3	14.1	0.563	0.555
B	2.30	2.20	0.091	0.087
C	17	16.8	0.669	0.661

P14

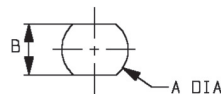

	MM		INCH	
	maxi	mini	maxi	mini
A	16.1	16	0.634	0.63
B	13.7	13.6	0.539	0.535

P15

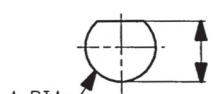

	MM		INCH	
	maxi	mini	maxi	mini
A	14.3	14.1	0.563	0.56
B	13.8	13.6	0.543	0.535

P16

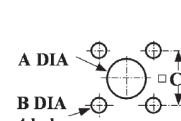

	mm	
	Maxi	mini
A	4.25	4.15
B	3.4	3.2
C	12.8	12.6

Cable designation	Cable Group Ø / Ω	Imp. Ω	Cable dimensions mm (inch)					Radiall cable if applicable		
			Core type	Core Ø	Insulator Ø	Screen	Outer Ø	P/N	Remark	
RG 174 A/U	2.6 / 50 S	50	7 x 0.16	0.48 (.019)	1.52 (.060)	S	2.79 (.110)	C291 150 000	PVC jacket	
RG 178 B/U	2 / 50 S	50	7 x 0.1	0.30 (.012)	0.84 (.033)	S	1.78 (.070)	C291 145 007	FEP jacket	
RG 178 B/U	2 / 50 S	50	7 x 0.1	0.30 (.012)	0.84 (.033)	S	1.83 (.072)	C291 145 060	PVC jacket	
RG178nonm.	2 / 50 S	50	7 x 0.1	0.29 (.011)	0.84 (.033)	S	1.80 (.071)	C291 140 087	non magnetic / FEP jacket	
RG 179 B/U	2.6 / 75 S	75	7 x 0.1	0.30 (.012)	1.60 (.063)	S	2.54 (.010)	C291 210 007	FEP jacket	
RG 187 A/U	2.6 / 75 S	75	7 x 0.1	0.30 (.012)	1.60 (.063)	S	2.79 (.110)	C291 211 006	PTFE jacket	
RG 188 A/U	2.6 / 50 S	50	7 x 0.17	0.51 (.020)	1.52 (.060)	S	2.79 (.110)	C291 160 006	PTFE jacket	
RG 196 A/U	2 / 50 S	50	7 x 0.1	0.30 (.012)	0.86 (.034)	S	2.03 (.080)	C291 110 006	PTFE jacket	
RG 212 /U	8 / 50 D	50	solid	1.41 (.056)	4.70 (.185)	D	8.43 (.331)	na		
RG 213 /U	10 / 50 S	50	7 x 0.75	2.26 (.089)	7.24 (.285)	S	10.30 (.406)	C291 510 000	PVC jacket	
RG 214 /U	11 / 50 D	50	7 x 0.75	2.25 (.089)	7.24 (.285)	D	10.80 (.425)	C291 600 000	PVC jacket	
RG 215	10 / 50 S	50	7 x 0.75	2.25 (.089)	7.25 (.285)	S	10.29 (.405)	na		
RG 216 /U	11 / 75 D	75	7 x 0.4	1.21 (.048)	7.24 (.285)	D	10.80 (.425)	C291 610 000	PVC jacket	
RG 217 /U	14 / 50 D	50	solid	2.69 (.106)	9.40 (.370)	D	13.84 (.545)	C291 620 000	PVC jacket	
RG 218 /U	22 / 50 S	50	solid	4.95 (.195)	17.27 (.680)	S	22.10 (.870)	C291 630 000	PVC jacket	
RG 223 /U	5 / 50 D	50	solid	0.89 (.035)	2.95 (.116)	D	5.38 (.212)	C291 330 000	PVC jacket	
RG 225 /U	11 / 50 D	50	7 x 0.8	2.38 (.094)	7.24 (.285)	D	10.90 (.429)	C291 605 007	glass fiber jacket	
RG 303 /U	5 / 50 S	50	solid	0.94 (.037)	2.95 (.116)	S	4.32 (.170)	na		
RG 316 /U	2.6 / 50 S	50	7 x 0.17	0.53 (.021)	1.52 (.060)	S	2.49 (.098)	C291 170 007	FEP jacket	
RD 316	2.6 / 50 D	50	7 x 0.17	0.53 (.021)	1.52 (.060)	D	2.80 (.110)	C291 185 067	FEP jacket	
RG 393	10 / 50 D	50	7 x 0.81	2.39 (.094)	7.24 (.285)	D	9.91 (.390)	C291 511 007	FEP jacket	
RG 400	5 / 50 / D	50	19 x 0.19	0.98 (.039)	2.95 (.116)	D	4.95 (.195)	C291 324 007	FEP jacket	
Flexible cable BT approved										
RD 179	2.6 / 75 D	75	7 x 0.10	0.30 (.012)	1.6 (.063)	D	3.07 (.121)	C291 230 080	LSOH jacket	
BT 3002	3.6 / 75 D	75	solid	0.31 (.012)	1.95 (.077)	D	3.55 (.140)	C291 246 046	FEP jacket	
BT 2002	5 / 75 D	75	7 x 0.20	0.60 (.024)	2.5 (.098)	D	5.1 (.200)	C291 333 080	FEP jacket	
Semi rigid cables MIL-C-17 standard										
RG 401 /U	.250"	50	solid	1.63 (.064)	5.31 (.209)	--	6.35 (.250)	C291 870 001	copper tubing	
RG 401 alu	.250"	50	solid	1.63 (.064)	5.31 (.209)	--	6.35 (.250)	C291 874 187	tinned alu tubing	
RG 402 /U	.141"	50	solid	0.92 (.036)	2.98 (.117)	--	3.58 (.141)	C291 860 001	copper tubing	
RG 402 tin	.141"	50	solid	0.92 (.036)	2.98 (.117)	--	3.58 (.141)	C291 862 005	tinned copper tubing	
RG402silver	.141"	50	solid	0.92 (.036)	2.98 (.117)	--	3.58 (.141)	C291 861 066	silvered copper tubing	
RG 402 alu	.141"	50	solid	0.92 (.036)	2.98 (.117)	--	3.58 (.141)	C291 864 187	tinned alu tubing	
RG402nonm.	.141"	50	solid	0.92 (.036)	2.98 (.117)	--	3.58 (.141)	C291 861 061	non magnetic / copper tubing	
RG 405 /U	.085"	50	solid	0.51 (.020)	1.68 (.066)	--	2.20 (.087)	C291 850 001	copper tubing	
RG 405 tin	.085"	50	solid	0.51 (.020)	1.68 (.066)	--	2.20 (.087)	C291 850 005	tinned copper tubing	
RG 405 alu	.085"	50	solid	0.51 (.020)	1.68 (.066)	--	2.20 (.087)	C291 844 187	tinned alu tubing	
RG405nonm.	.085"	50	solid	0.51 (.020)	1.68 (.066)	--	2.20 (.087)	C291 851 001	non magnetic / copper tubing	
.047"	.047"	50	solid	0.29 (.011)	0.94 (.037)	--	1.19 (.047)	C291 855 001	copper tubing	
.047" tin	.047"	50	solid	0.29 (.011)	0.94 (.037)	--	1.19 (.047)	C291 855 065	tinned copper tubing	
Hand-formable cable										
Hand-formable	.085"	50	solid	0.51 (.020)	1.63 (.064)	--	2.21 (.087)	C291 844 065	tin soaked braid	
Hand-formable	.141"	50	solid	0.92 (.036)	2.95 (.116)	--	3.50 (.138)	C291 864 065	tin soaked braid	
Hand-formable	.141"	50	solid	0.92 (.036)	2.98 (.117)	--	4.05 (.159)	C291 866 378	FEP jacket	
Hand-formable	.141"	50	solid	0.92 (.036)	2.98 (.117)	--	4.50 (.177)	C291 866 270	LSZH jacket	
Corrugated cables (with helical or ringed/annular copper tube)										
Flexible	1/4"	50	solid	2.38 (.094)	6.40 (.252)	--	8.70 (.343)	na	ringed/annular tube	
Flexible	1/2"	50	solid	4.80 (.189)	11.6 (.457)	--	16.35 (.644)	C291 972 085	ringed/annular tube	
Flexible	7/8"	50	solid	9.13 (.359)	22.5 (.866)	--	27.7 (1.091)	na	ringed/annular tube	
Flexible	1 1/4"	50	solid	12.7 (.500)	32.5 (1.28)	--	39.5 (1.55)	na	ringed/annular tube	
Flexible	1 5/8"	50	solid	17.3 (.681)	43.5 (1.71)	--	50.5 (1.99)	na	ringed/annular tube	
Super flexible	1/4"	50	solid	1.90 (.075)	4.70 (.185)	--	7.40 (.291)	C291 993 080	helical tube	
Super flexible	3/8"	50	solid	2.60 (.102)	6.30 (.248)	--	10.8 (.425)	C291 996 070	helical tube	
Super flexible	1/2"	50	solid	3.60 (.142)	8.70 (.343)	--	13.2 (.520)	C291 994 080	helical tube	
Super flexible	7/8"	50	tube	9.04 (.356)	23.62 (.930)	--	27.48 (1.082)	C291 996 580	helical tube	

Note: S = single braid. D = dual braid.

For more information about cables manufactured by Radiall, please consult our online catalog.

www.radiall.com

X-ON Electronics

Largest Supplier of Electrical and Electronic Components

Click to view similar products for [RF Adapters - Tee category](#):

Click to view products by [Radiall manufacturer](#):

Other Similar products are found below :

[R142782000](#) [R114780000W](#) [R142780000W](#) [R143780000](#) [R143782000](#) [344A505](#) [TN2](#) [443A505](#) [R125780000](#) [BNC-TA-JJJ\(40\)](#)
[R125780001](#) [034-1023](#) [ADP-BNCF-2BNCF](#) [73148-5003](#) [31-208-1051](#) [CT3312](#) [53S301-K00N5](#) [CT2411](#) [43_SMB-50-0-2/111_NE](#) [32K301-](#)
[K00L5](#) [46_SMA-50-0-1/111_NE](#) [51S303-K00N5](#) [32S301-K00L5](#) [43_N-50-0-1/133_NE](#) [CPAD705](#) [BN153](#) [031-208-1051](#) [031-70036](#) [082-](#)
[102](#) [112455](#) [112456](#) [112459](#) [112461](#) [112462](#) [112567](#) [112590](#) [122354](#) [122356](#) [132216](#) [132217](#) [142300](#) [172125](#) [172127](#) [172233](#) [21900](#) [31-](#)
[208](#) [31-208-RFX](#) [31-2208](#) [31-8](#) [34-1023](#)