

STRAIGHT PLUG CRIMP TYPE

R166.092.190

CABLE 8.07/50

Series : C

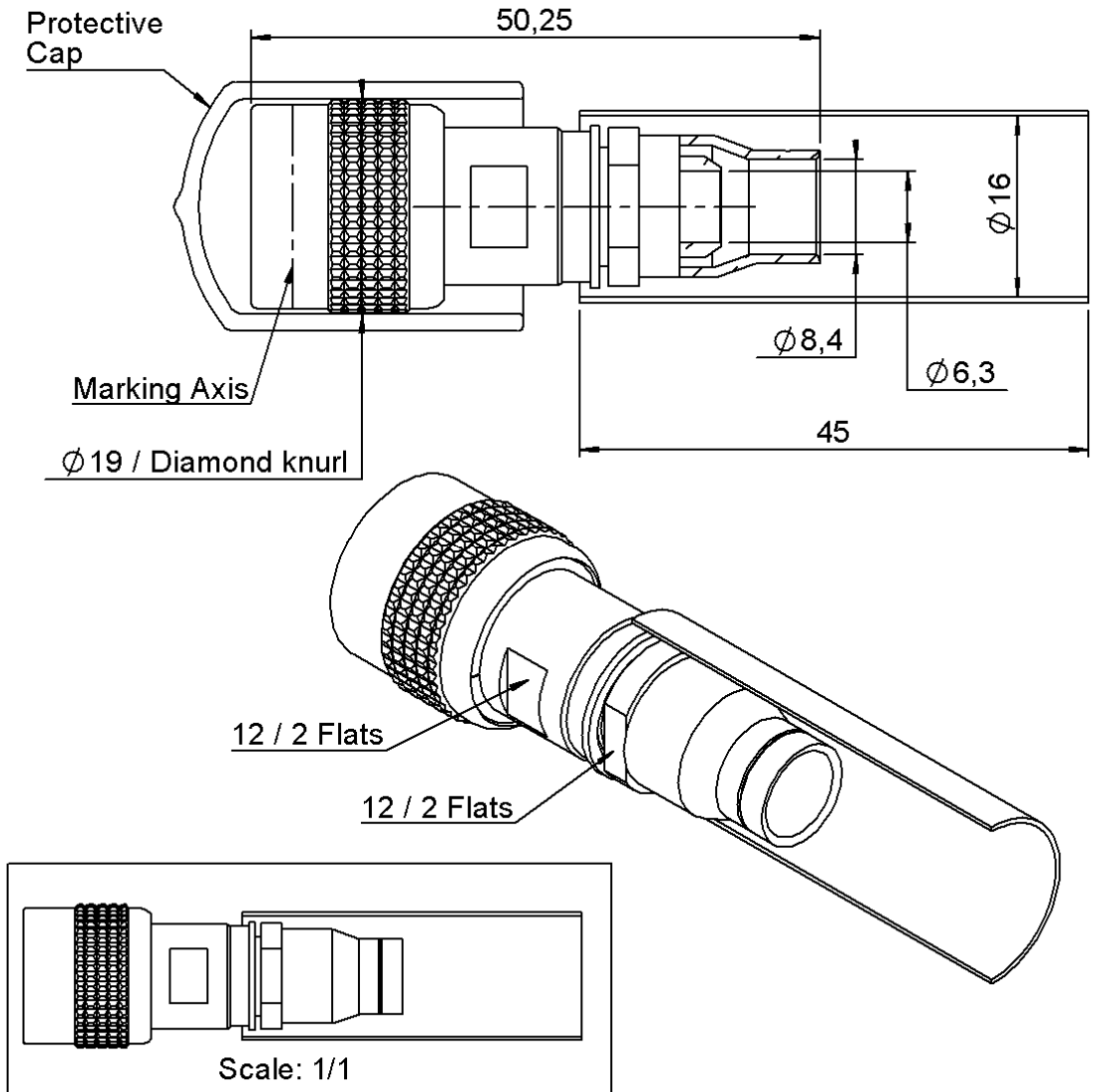

All dimensions are in mm.

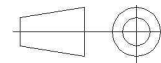

COMPONENTS	MATERIALS	PLATING (µm)
BODY	BRASS	NICKEL 2
CENTER CONTACT	BRASS	GOLD 0.5 OVER NICKEL 2
OUTER CONTACT	BRONZE	NICKEL 2
INSULATOR	PTFE	
GASKET	SILICONE RUBBER	
OTHERS PARTS	BRASS	NICKEL 2
-	-	-
-	-	-

Issue : 1406 B

In the effort to improve our products, we reserve the right to make changes judged to be necessary.



STRAIGHT PLUG CRIMP TYPE

R166.092.190

CABLE 8.07/50

Series : C

PACKAGING

Standard	Unit	Other
1	-	Contact us

SPECIFICATION

**QAE 06-02 -
ASNE 0463-F02**

ELECTRICAL CHARACTERISTICS

Impedance		50 Ω
Frequency		0-3 GHz
VSWR	1.15 +	0,0000 x F(GHz) Maxi
Insertion loss		0.1 √F(GHz) dB Maxi
RF leakage	- (NA - F(GHz)) dB Maxi
Voltage rating		1000 Veff Maxi
Dielectric withstanding voltage		1500 Veff mini
Insulation resistance		5000 MΩ mini

CABLE ASSEMBLY

Stripping	a	b	c	d	e	f
mm	9,00	9,00	27,0	0,00	0,00	0,00

Assembly instruction :

Recommended cable(s)
ASNE0406-WD
ASNE0692-WN

MECHANICAL CHARACTERISTICS

Center contact retention		
Axial force – Mating end	27	N mini
Axial force – Opposite end	27	N mini
Torque	NA	N.cm mini

Characteristics indicated on this data sheet are those that can be achieved with the highest performance cable. Intrinsic limitations of the cable may diminish the performance of the assembly

Cable retention

- pull off	400	N mini
- torque	NA	N.cm

Recommended torque

Mating	NA	N.cm
Panel nut	NA	N.cm
Clamp nut	370	N.cm
A/F clamp nut	12,0000	mm

Mating life	500	Cycles mini
Weight	39,5700	g

TOOLING

Part Number	Description	Hexagon
282247	CRIMPING DIE M 22520/5-61	10.9
282291	CRIMPING TOOL M22520/1-01	2x4 (loc 8)
282997	POSITIONER FOR TOOL 282.291(M22520/1-13)	Red
R282293000	CRIMPING TOOL M22520/5-01	

ENVIRONMENTAL

Operating temperature	-65/+165	° C
Hermetic seal	NA	Atm.cm3/s
Panel leakage	NA	

OTHER CHARACTERISTICS

Issue : 1406 B

In the effort to improve our products, we reserve the right to make changes judged to be necessary.



STRAIGHT PLUG CRIMP TYPE

R166.092.190

CABLE 8.07/50

Series : C

COMPONENTS

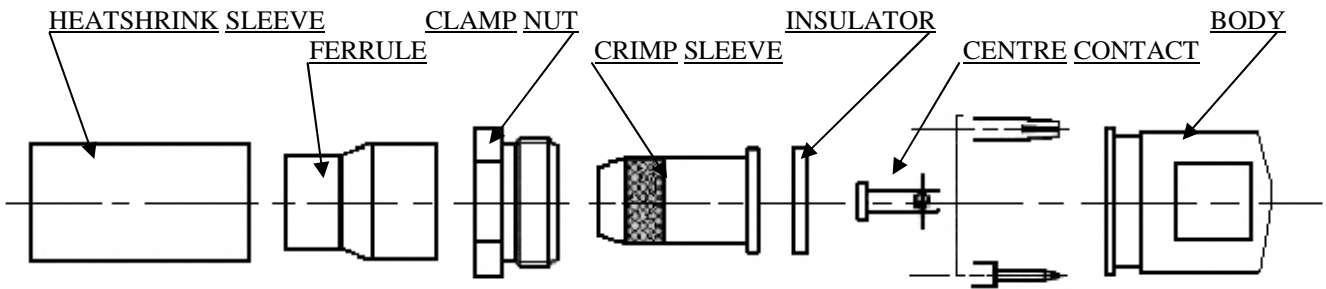

1

Slide onto the cable the heatshrink and the ferrule.
Strip the cable.

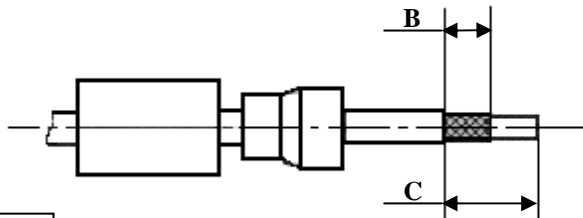

2

Slide the clamp nut onto the crimp sleeve.
Slide sub-assembly under the braid.
Slide ferrule over the braid against clamp nut. (In direction F)
Crimp the ferrule with crimping tool + dies

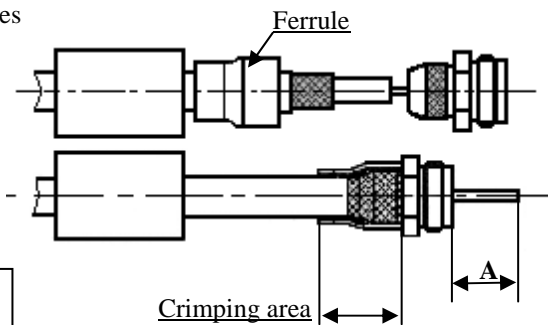

3

Cut the dielectric flush to crimp sleeve.
Mount insulator against crimp sleeve.

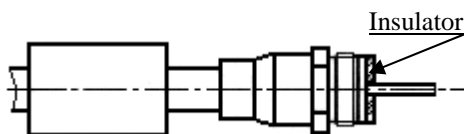

4

Slide the centre contact onto the cable inner conductor against insulator.
Crimp centre contact with the crimping tool and the positioner.

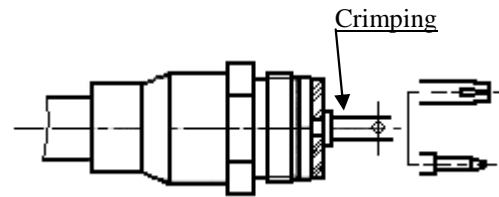

5

Screw sub-assembly into the connector body.
(recommended coupling see the connector TDS)
Slide sleeve over ferrule and heatshrink sleeve in the place.

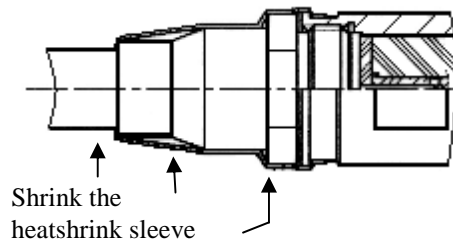

Issue : 1406 B

In the effort to improve our products, we reserve the right to make changes judged to be necessary.



X-ON Electronics

Largest Supplier of Electrical and Electronic Components

Click to view similar products for [RF Connectors / Coaxial Connectors](#) category:

Click to view products by [Radiall](#) manufacturer:

Other Similar products are found below :

[8915-1511-000](#) [89674-0827](#) [6001-7071-019](#) [6002-7051-003](#) [6002-7551-202](#) [6059674-1](#) [619550-1](#) [630059-000](#) [M39030/3-01N](#) [6500-7071-046](#) [6769](#) [CX050L2AQ](#) [7002-1541-010](#) [7002-1542-011](#) [7004-1512-000](#) [7009-1511-004](#) [7010-1511-000](#) [7029-1511-060](#) [7101-1541-010](#) [7101-1571-002](#) [7145-1521-002](#) [7203-1571-003](#) [7209-1511-011](#) [7210-1511-015](#) [7210-1511-019](#) [73137-5015](#) [73216-2241](#) [73404-2300](#) [7405-1521-005](#) [7405-1521-802](#) [8527](#) [8547](#) [FS11V](#) [877931](#) [8808-1511-001](#) [9074-9513-000](#) [9101-9573-002](#) [910A205F](#) [9130-9573-002](#) [PL11SC-026](#) [PL375-33](#) [PL40-5](#) [PL74C-221](#) [PL75MC-217](#) [PL803-7](#) [1200690078](#) [1-201144-1](#) [R107003010W](#) [R110A172100](#) [R112186000](#)