

**STRAIGHT PLUG FULL CRIMP TYPE
CABLE 2.6/75 S**

R213.082.007
SERIES MCX 75

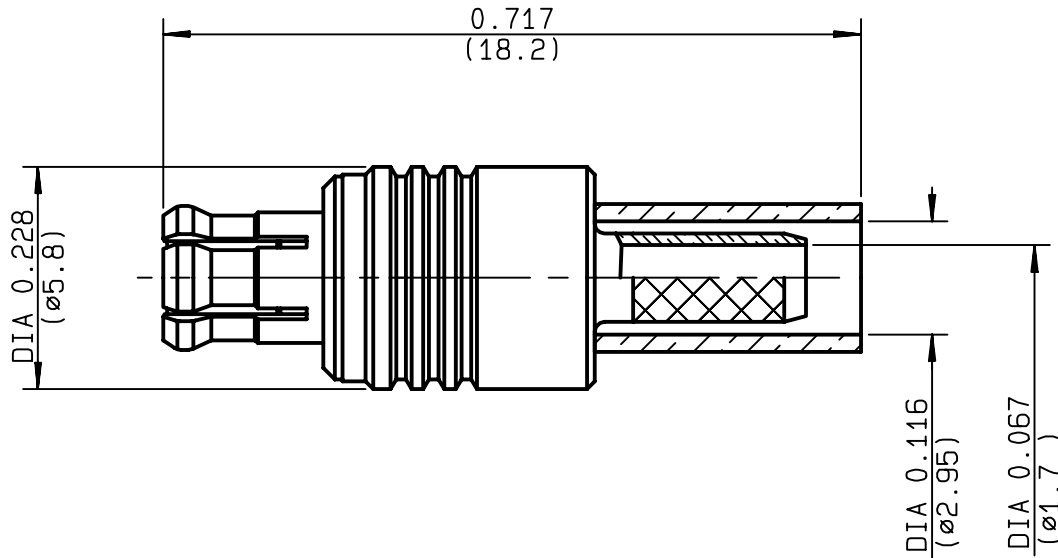

NOMINAL IMPEDANCE	75 Ω
FREQUENCY RANGE	0-6 GHz
TEMPERATURE RATING	-55/+155 °C
V.S.W.R	1.05 + .02 x F(GHz)Maxi
RF INSERTION LOSS	0.06 √F(GHz) dB Maxi
VOLTAGE RATING	335 Veff Maxi
DIELECTRIC WITHSTANDING VOLTAGE	750 Veff Mini
INSULATION RESISTANCE	1000 MΩMini
HERMETIC SEAL	NA Atm.cm ³ /s
LEAKAGE (pressurized only)	NA
MECHANICAL DURABILITY	500 Cycles
WEIGHT	1.4 gr
SPECIFICATION	

CABLES : **RG 179**
RG 187

OTHERS CHARACTERISTICS

CABLE RETENTION	53 N Mini
CENTER CONTACT RETENTION	
Axial force - mating end	10 N Mini
Axial force - opposite end	10 N Mini
Torque	NA cm.N Mini
RECOMMENDED TORQUES	
Mating	NA cm.N
Panel nut	NA cm.N
Clamp nut	NA cm.N

CONNECTOR PARTS	MATERIALS	FINISH	(all values are given) in micrometers
BODY	BRASS	BBR 2	
OUTER CONTACT	BERYLLIUM COPPER	BBR 2	
CENTER CONTACT	BRASS	GOLD 1.3 OVER NICKEL 2	
INSULATOR	PTFE	-	
GASKET		-	
OTHERS PIECES	BRASS	BBR 2	

ISSUE	CREATION DATE	FILE PART-NUMBER
9916A02	22/08/1996	95-1200-001



RADIALL®

AGRIODOS

The information given here is subject to change without notice.
Design changes may be in order to improve the product .

Connect to the future



R213.082.007

ISSUE **9916A02** SERIES **MCX 75**

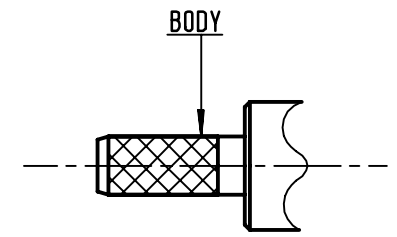
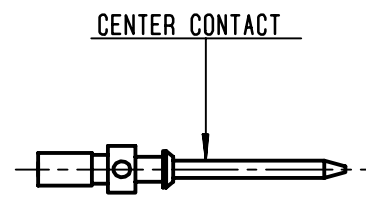
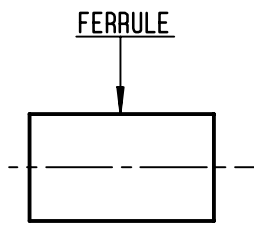

①

Slide ferrule onto cable .
Strip the cable .
-
-

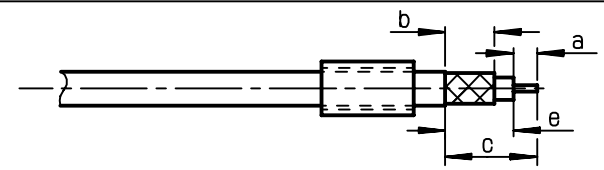

Stripping	a	b	c	d	e
inch	0.091	0.217	0.406	0	0.315
mm	2.3	5.5	10.3		8

②

Crimp the center contact with the crimping tool R282.271.000 square .028 (carre 0.72)
-
-
-
-
-

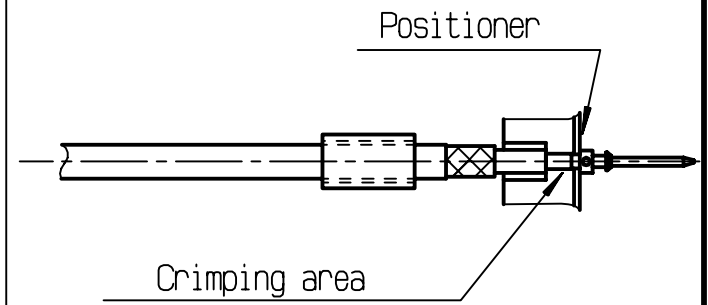

③

Open the braid
Slide body under braid
Slide ferrule over the braid
(In direction F)
-

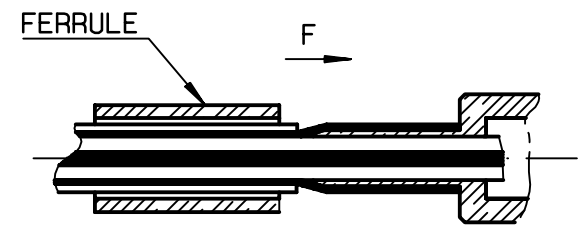

④

Crimp the ferrule with crimping tool R282.271.000 (Hex. : .127) (3.25)
-
-
-

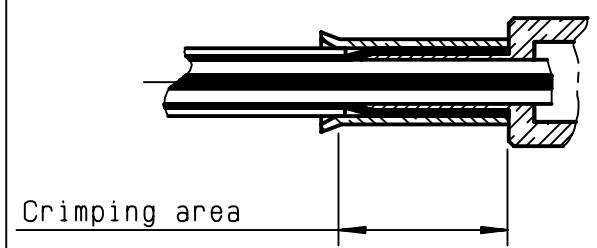

AGRIODOS

X-ON Electronics

Largest Supplier of Electrical and Electronic Components

Click to view similar products for [RF Connectors / Coaxial Connectors](#) category:

Click to view products by [Radiall](#) manufacturer:

Other Similar products are found below :

[8915-1511-000](#) [89674-0827](#) [6001-7071-019](#) [6002-7051-003](#) [6002-7551-202](#) [6059674-1](#) [619550-1](#) [630059-000](#) [M39030/3-01N](#) [6500-7071-046](#) [6769](#) [CX050L2AQ](#) [7002-1541-010](#) [7002-1542-011](#) [7004-1512-000](#) [7009-1511-004](#) [7010-1511-000](#) [7029-1511-060](#) [7101-1541-010](#) [7101-1571-002](#) [7105-1521-002](#) [7145-1521-002](#) [7203-1571-003](#) [7209-1511-011](#) [7210-1511-015](#) [7210-1511-019](#) [73137-5015](#) [73216-2241](#) [73404-2300](#) [7405-1521-005](#) [7405-1521-802](#) [8527](#) [8547](#) [FS11V](#) [877931](#) [8808-1511-001](#) [9074-9513-000](#) [9101-9573-002](#) [910A205F](#) [9130-9573-002](#) [PL11SC-026](#) [PL375-33](#) [PL40-5](#) [PL74C-221](#) [PL75MC-217](#) [PL803-7](#) [1200690078](#) [1-201144-1](#) [R107003010W](#) [R110A172100](#)