

PAGE 1/3	ISSUE 12-03-19A	SERIES SMPW	PART NUMBER R218508700
----------	-----------------	--------------------	-------------------------------

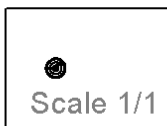

All dimensions are in mm. Tolerances according ISO 2768 m-H

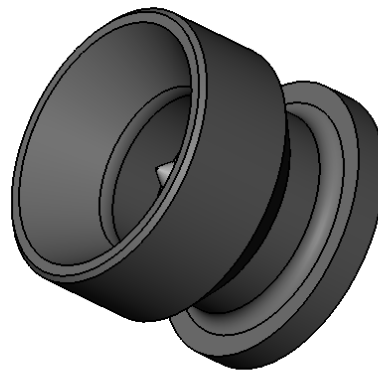
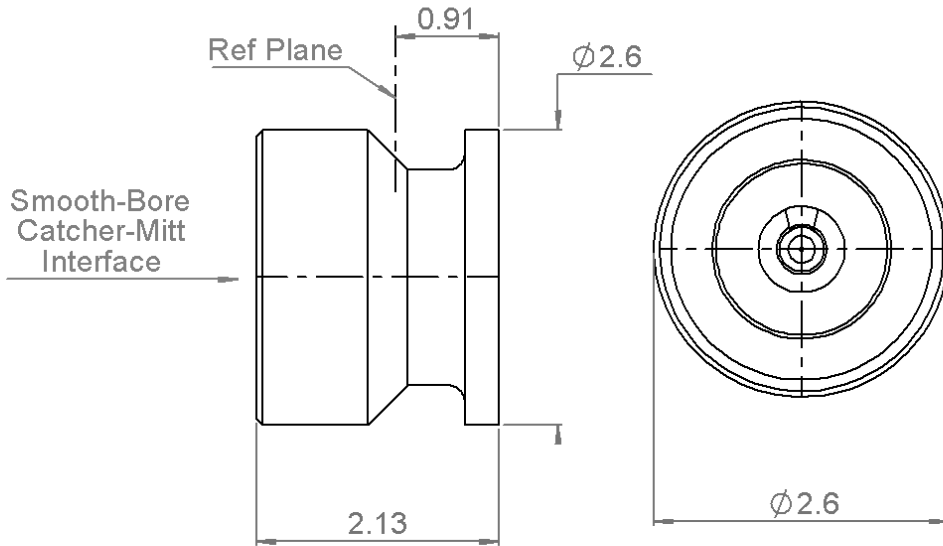
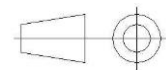

COMPONENTS	MATERIALS	PLATING (μm)
Body	BRONZE	GOLD OVER NICKEL
Center contact	BERYLLIUM COPPER	GOLD OVER NICKEL
Outer contact		
Insulator	PEEK	
Gasket		
Others parts		
-	-	-
-	-	-

PAGE 2/3	ISSUE 12-03-19A	SERIES SMPW	PART NUMBER R218508700
----------	------------------------	--------------------	-------------------------------

PACKAGING

Standard	Unit	Other
100	Contact us	Contact us

ELECTRICAL CHARACTERISTICS

Impedance		50	Ω	
Frequency		0-100	GHz	
VSWR	see* +	0,0000	x F(GHz) Maxi	
Insertion loss		-	√F(GHz) dB Maxi	
RF leakage	- (-	- F(GHz)) dB Maxi	
Voltage rating		125	Veff Maxi	
Dielectric withstanding voltage		250	Veff mini	
Insulation resistance		3500	MΩ mini	

MECHANICAL CHARACTERISTICS

Center contact retention				
Axial force – Mating End		-	N mini	
Axial force – Opposite end		-	N mini	
Torque		NA	N.cm mini	

Recommended torque				
Mating		NA	N.cm	
Panel nut		NA	N.cm	

Mating life		500	Cycles mini	
Nominal Weight (Add +15% for max weight)		0,0500	g	

ENVIRONMENTAL

Operating temperature	-40/+125	°C	
Hermetic seal	NA	Atm.cm3/s	
Panel leakage	NA		

SPECIFICATION

OTHER CHARACTERISTICS

Assembly instruction:

Others:

***Coaxial transmission line only**
***1.1(DC to 26.5Ghz) 1.25(26.5 to 65Ghz)**

-

PAGE 3/3	ISSUE 12-03-19A	SERIES SMPW	PART NUMBER R218508700
----------	-----------------	-------------	------------------------

PCB

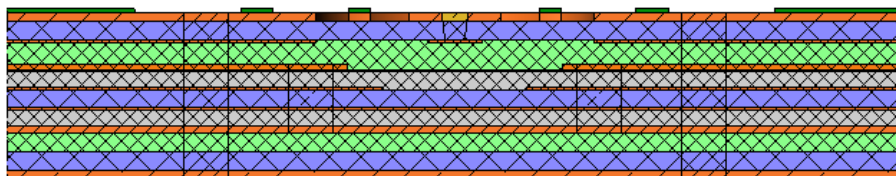
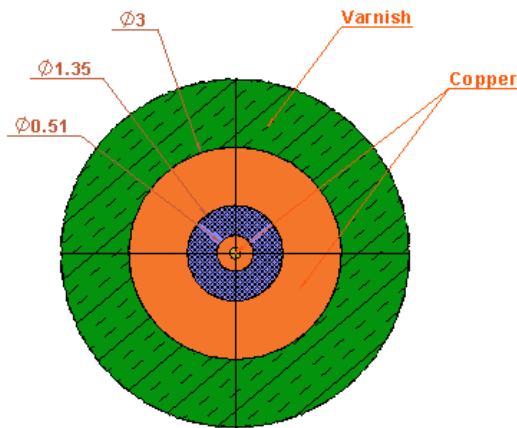
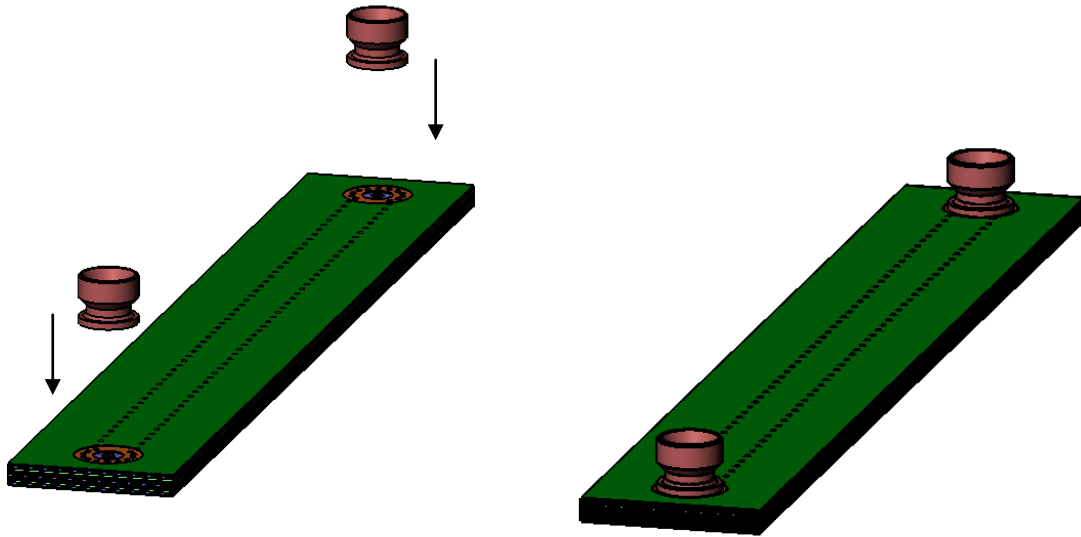

Complete and detailed information concerning PCB structure and layout for RF adaptation are available on demand.

X-ON Electronics

Largest Supplier of Electrical and Electronic Components

Click to view similar products for [RF Connectors](#) / [Coaxial Connectors](#) category:

Click to view products by [Radiall](#) manufacturer:

Other Similar products are found below :

[8915-1511-000](#) [89674-0827](#) [6001-7071-019](#) [6002-7051-003](#) [6002-7551-202](#) [6059674-1](#) [619550-1](#) [630059-000](#) [M39030/3-01N](#) [6500-7071-046](#) [6769](#) [CX050L2AQ](#) [7002-1541-010](#) [7002-1542-011](#) [7004-1512-000](#) [7009-1511-004](#) [7010-1511-000](#) [7029-1511-060](#) [7101-1541-010](#) [7101-1571-002](#) [7145-1521-002](#) [7203-1571-003](#) [7209-1511-011](#) [7210-1511-015](#) [7210-1511-019](#) [73137-5015](#) [73216-2241](#) [73404-2300](#) [7405-1521-005](#) [7405-1521-802](#) [8527](#) [8547](#) [FS11V](#) [877931](#) [8808-1511-001](#) [9074-9513-000](#) [9101-9573-002](#) [910A205F](#) [9130-9573-002](#) [PL11SC-026](#) [PL375-33](#) [PL40-5](#) [PL74C-221](#) [PL75MC-217](#) [PL803-7](#) [1200690078](#) [1-201144-1](#) [R107003010W](#) [R110A172100](#) [R112186000](#)