

PAGE 1/3	ISSUE 1438C	SERIES SMP	PART NUMBER R222302302
----------	-------------	------------	------------------------

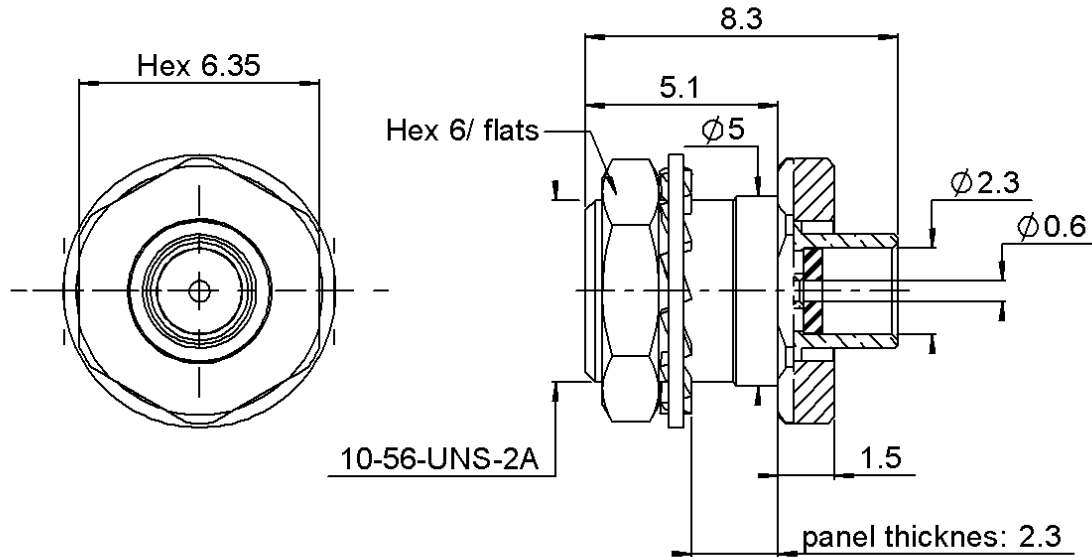

**PANEL CUT OUT**

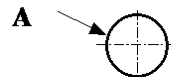

	mm	
	Maxi	mini
A	5.30	5.20

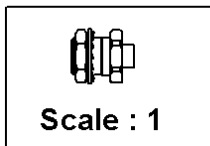

All dimensions are in mm.

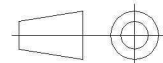
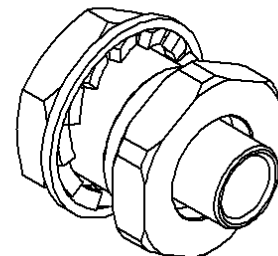

COMPONENTS	MATERIALS	PLATING (µm)
Body	STAINLESS STEEL + BRASS	PASSIVATED+GOLD1.3 OVER NICKEL2
Center contact	BERYLLIUM COPPER	GOLD 1.27 OVER NICKEL 1.27
Outer contact	-	-
Insulator	PTFE	-
Gasket	-	-
Others parts	BRASS	NICKEL 2
-	-	-
-	-	-

PAGE <b>2/3</b>	ISSUE <b>1438C</b>	SERIES <b>SMP</b>	PART NUMBER <b>R222302302</b>
-----------------	--------------------	-------------------	-------------------------------

### PACKAGING

Standard	Unit	Other
<b>100</b>	<b>Contact us</b>	<b>Contact us</b>

### ELECTRICAL CHARACTERISTICS

Impedance	<b>50</b>	$\Omega$
Frequency	<b>0-40</b>	GHz
VSWR	<b>1.50 + 0,0000</b>	x F(GHz) Maxi
Insertion loss	<b>0.12</b>	$\sqrt{F}$ (GHz) dB Maxi
RF leakage	- (	- F(GHz)) dB Maxi
Voltage rating	<b>335</b>	Veff Maxi
Dielectric withstanding voltage	<b>500</b>	Veff mini
Insulation resistance	<b>5000</b>	M $\Omega$ mini

### ENVIRONMENTAL

Operating temperature	<b>-65/+165</b>	$^{\circ}\text{C}$
Hermetic seal	<b>NA</b>	Atm.cm3/s
Panel leakage	<b>NA</b>	

### SPECIFICATION

### MECHANICAL CHARACTERISTICS

Center contact retention		
Axial force – Mating End	<b>NA</b>	N mini
Axial force – Opposite end	<b>NA</b>	N mini
Torque	<b>NA</b>	N.cm mini
Recommended torque		
Mating	<b>NA</b>	N.cm
Panel nut	<b>60</b>	N.cm
Clamp nut	<b>NA</b>	N.cm
A/F clamp nut	<b>0,0000</b>	mm
Mating life	<b>500</b>	Cycles mini
Weight	<b>1,1400</b>	g

### CABLE ASSEMBLY

Stripping	a	b	c	d	e	f
mm	<b>1,3</b>	<b>0</b>	<b>0</b>	<b>0</b>	<b>0</b>	<b>0</b>

Assembly instruction:

Recommended cable(s)

**RG 405**  
**KS 1**

Characteristics indicated on this data sheet are those that can be achieved with the highest performance cable. Intrinsic limitations of the cable may diminish the performance of the assembly

Cable retention

- pull off	<b>200</b>	N mini
- torque	<b>NA</b>	N.cm

### TOOLING

Part Number	Description	Hexagon
R282051000	STRIPPING TOOL	
R282062010	POINTER GAUGE	
R282743100	POSITIONER FOR SOLDERING SMP	
R282744254	POSITIONER FOR SOLDERING SMP	
R282862120	SOLDER GAUGE THCK 1.83	
R282740000	SOLDERING MOUNTING	

### OTHER CHARACTERISTICS

**RF leakage -80dB DC-3 GHz**  
**-65dB from 3-26.5 GHz**  
**Compliant with MIL-STD-348**

PAGE 3/3	ISSUE 1438C	SERIES SMP	PART NUMBER R222302302
----------	-------------	------------	------------------------

**COMPONENTS**

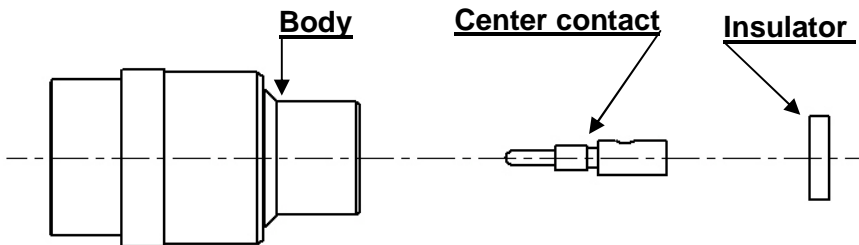

**STRIPPING CABLES**

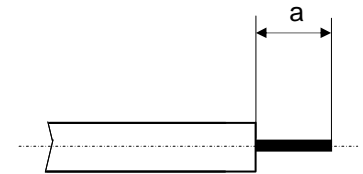

**We recommend a thermal preconditioning cable**

**1**

Strip the dielectric of the cable .  
Clean the cable .  
Soldering 180°C  
Temperature stoking do not exceeded 250°C

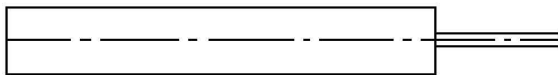

**2**

Screw the positioner onto the soldering jig.  
Slide the center contact onto the cable inner conductor against insulator.  
Fit the cable assembly onto the soldering jig.  
Insert the soldering gauge  
Tighten.  
Take off the soldering gauge.  
and solder the contact.

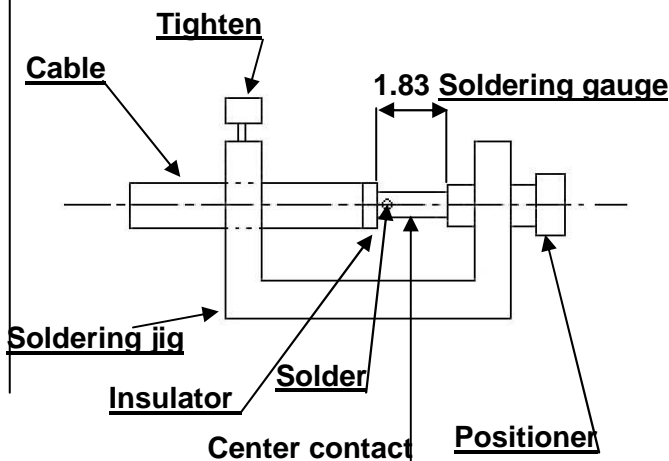

**3**

After cooling remove cable assembly from the jig.  
Insert cable+centre contact in the connector.  
Slide the positioner in the connector interface.  
Slide cable into the connector body until it bottoms against.  
Slide positioner into the assembly.  
Tighten.  
Solder the body onto the cable.  
After cooling remove cable assembly from the jig.

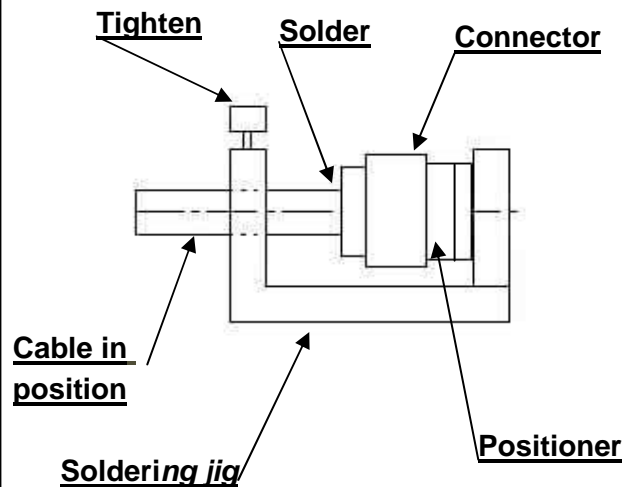

## X-ON Electronics

Largest Supplier of Electrical and Electronic Components

*Click to view similar products for [RF Connectors / Coaxial Connectors](#) category:*

*Click to view products by [Radiall](#) manufacturer:*

Other Similar products are found below :

[8915-1511-000](#) [89674-0827](#) [6001-7071-019](#) [6002-7051-003](#) [6002-7551-202](#) [6059674-1](#) [619550-1](#) [630059-000](#) [M39030/3-01N](#) [6500-7071-046](#) [6769](#) [CX050L2AQ](#) [7002-1541-010](#) [7002-1542-011](#) [7004-1512-000](#) [7009-1511-004](#) [7010-1511-000](#) [7029-1511-060](#) [7101-1541-010](#) [7101-1571-002](#) [7145-1521-002](#) [7203-1571-003](#) [7209-1511-011](#) [7210-1511-015](#) [7210-1511-019](#) [73137-5015](#) [73216-2241](#) [73404-2300](#) [7405-1521-005](#) [7405-1521-802](#) [8527](#) [8547](#) [FS11V](#) [877931](#) [8808-1511-001](#) [9074-9513-000](#) [9101-9573-002](#) [910A205F](#) [9130-9573-002](#) [PL11SC-026](#) [PL375-33](#) [PL40-5](#) [PL74C-221](#) [PL75MC-217](#) [PL803-7](#) [1200690078](#) [1-201144-1](#) [R107003010W](#) [R110A172100](#) [R112186000](#)