

**STRAIGHT PLUG SOLDER TYPE**

**R222.900.200**

**CABLE .085**

Series : SMP-COM

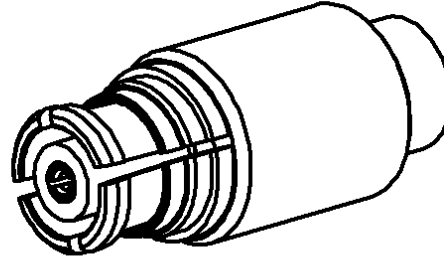
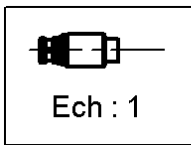
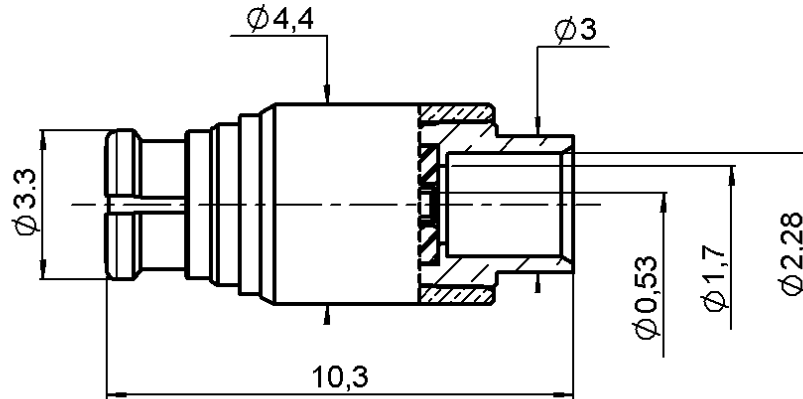

All dimensions are in mm.

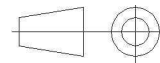

COMPONENTS	MATERIALS	PLATING ( $\mu\text{m}$ )
BODY	BRASS	NPGR
CENTER CONTACT	BERYLLIUM COPPER	NPGR
OUTER CONTACT	BERYLLIUM COPPER	NPGR
INSULATOR	PTFE	
GASKET	-	
OTHERS PARTS	BRASS	NPGR
-	-	-
-	-	-

Issue : 0846 A

In the effort to improve our products, we reserve the right to make changes judged to be necessary.



**RADIALL**®

**STRAIGHT PLUG SOLDER TYPE**

**R222.900.200**

**CABLE .085**

Series : SMP-COM

**PACKAGING**

Standard	Unit	Other
<b>100</b>	<b>'W' option</b>	<b>Contact us</b>

**SPECIFICATION**

**ELECTRICAL CHARACTERISTICS**

Impedance	<b>50</b>	$\Omega$
Frequency	<b>0-12.4*</b>	GHz
VSWR	<b>1.15** + 0,0000</b>	x F(GHz) Maxi
Insertion loss	<b>0.12</b>	$\sqrt{F}$ (GHz) dB Maxi
RF leakage	<b>- ( 55***</b>	- F(GHz)) dB Maxi
Voltage rating	<b>335</b>	Veff Maxi
Dielectric withstanding voltage	<b>500</b>	Veff mini
Insulation resistance	<b>5000</b>	M $\Omega$ mini

**CABLE ASSEMBLY**

Stripping	a	b	c	d	e	f
mm	1,30	0,00	0,00	0,00	0,00	0,00

Assembly instruction :

Recommended cable(s)  
KS 1  
RG 405

Characteristics indicated on this data sheet are those that can be achieved with the highest performance cable. Intrinsic limitations of the cable may diminish the performance of the assembly

Cable retention

- pull off **200** N mini  
- torque **NA** N.cm

**MECHANICAL CHARACTERISTICS**

Center contact retention		
Axial force – Mating end	<b>NA</b>	N mini
Axial force – Opposite end	<b>NA</b>	N mini
Torque	<b>NA</b>	N.cm mini

Recommended torque		
Mating		N.cm
Panel nut		N.cm
Clamp nut		N.cm
A/F clamp nut	<b>0,0000</b>	mm

Mating life	<b>100</b>	Cycles mini
Weight	<b>0,6500</b>	g

**TOOLING**

Part Number	Description	Hexagon
.	.	.
R282.051.000	STRIPPING TOOL	
R282.062.010	POINTER GAUGE	
R282.740.030	SOLDERING MOUNTING	
R282.743.120	POSITIONER FOR SOLDERING SMP	
R282.744.253	POSITIONER FOR SOLDERING SMP	
R282.862.050	SOLDER GAUGE THCK .012	

**ENVIRONMENTAL**

Operating temperature	<b>-55/+105</b>	$^{\circ}$ C
Hermetic seal	<b>NA</b>	Atm.cm3/s
Panel leakage	<b>NA</b>	

**OTHER CHARACTERISTICS**

\*ROS: 1.35 at 12.4GHz  
\*\*ROS at 6GHz  
\*\*\*RF Leakage : -40dB min 3<F<6GHz

Issue : 0846 A

In the effort to improve our products, we reserve the right to make changes judged to be necessary.



**STRAIGHT PLUG SOLDER TYPE**

**R222.900.200**

**CABLE .085**

Series : SMP-COM

**COMPONENTS**

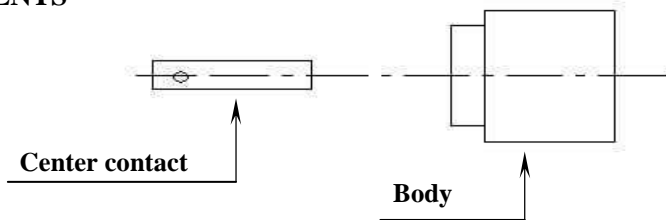

**STRIPPING CABLES**

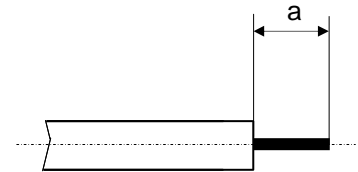

We recommend a thermal preconditioning cable

**1**

Strip the dielectric of the cable .  
Trim the cable.  
Clean the cable .  
Iron temperature not exceed 250°C

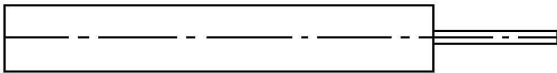

**2**

Screw the positioner onto the soldering jig.  
Slide center contact into positioner.  
Insert solder gauge between contact and cable .  
Tighten and solder the contact.

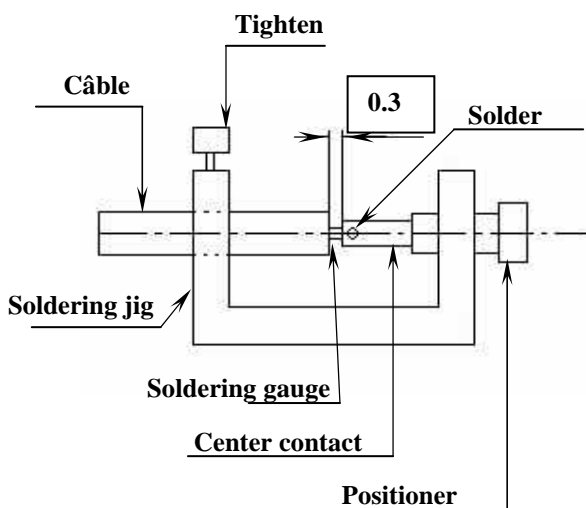

**3**

After cooling remove cable assembly from the jig.  
Slide body into positioner .  
Slide cable into the connector until it bottoms against the positioner .  
Tighten.  
Solder the body onto the cable.  
After cooling remove cable assembly from the jig.

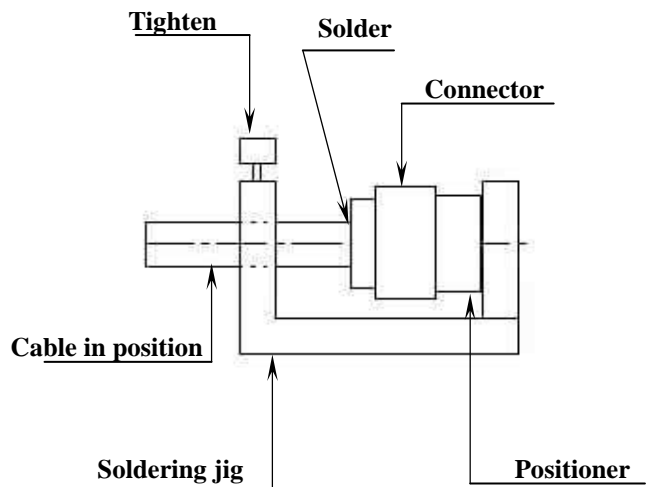

Issue : 0846 A

In the effort to improve our products, we reserve the right to make changes judged to be necessary.

## X-ON Electronics

Largest Supplier of Electrical and Electronic Components

*Click to view similar products for [RF Connectors / Coaxial Connectors](#) category:*

*Click to view products by [Radiall](#) manufacturer:*

Other Similar products are found below :

[8915-1511-000](#) [89674-0827](#) [6001-7071-019](#) [6002-7051-003](#) [6002-7551-202](#) [6059674-1](#) [619550-1](#) [630059-000](#) [M39030/3-01N](#) [6500-7071-046](#) [6769](#) [CX050L2AQ](#) [7002-1541-010](#) [7002-1542-011](#) [7004-1512-000](#) [7009-1511-004](#) [7010-1511-000](#) [7029-1511-060](#) [7101-1541-010](#) [7101-1571-002](#) [7145-1521-002](#) [7203-1571-003](#) [7209-1511-011](#) [7210-1511-015](#) [7210-1511-019](#) [73137-5015](#) [73216-2241](#) [73404-2300](#) [7405-1521-005](#) [7405-1521-802](#) [8527](#) [8547](#) [FS11V](#) [877931](#) [8808-1511-001](#) [9074-9513-000](#) [9101-9573-002](#) [910A205F](#) [9130-9573-002](#) [PL11SC-026](#) [PL375-33](#) [PL40-5](#) [PL74C-221](#) [PL75MC-217](#) [PL803-7](#) [1200690078](#) [1-201144-1](#) [R107003010W](#) [R110A172100](#) [R112186000](#)