

MMBX / MCX series

R223 / R113 / R213

RADIALL 
The next connexion

Pages

MMBX

Introduction 4-4 to 4-6

Interface 4-7

Characteristics 4-8

Plugs 4-9

Receptacles 4-9 to 4-10

Adapters 4-11

Demo board 4-12

Panel drilling 4-12

Receptacle packaging 4-12

Assembly instructions 4-13

MCX

Introduction 4-4 to 4-5 and 4-14

Interface 4-14

Characteristics 4-15 to 4-16

Plugs 4-17 to 4-18

Jacks 4-18

Receptacles 4-19 to 4-20

In series adapters 4-20

Panel drilling 4-21

Packaging 4-21

Assembly instructions 4-22

INTRODUCTION

BOARD TO BOARD SOLUTIONS

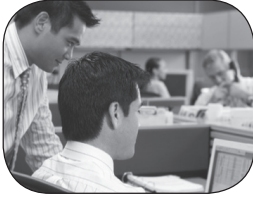

The Best Systems

Radiall's engineers work with your engineers allowing us to develop the best competitively priced misalignment RF coaxial interconnect solutions on the market today.

The Best Choices

Radiall offers more board 2 board choices with four different product groups and ten connector series that can address the most demanding wireless telecom applications required for the new generation of infrastructure compact equipment. From base stations to repeaters and even handheld and GPS devices, we have a tailored connector solution for you; including the new SMP-MAX, SMP-Spring, IMP-Spring and other large, limited and no misalignment solutions.



*SMP-MAX
Receptacle*

SMP-MAX

Get the best for less with the new SMP-MAX large misalignment solution. Its patented impedance matching insulator is optimized for a larger operating gap between connectors making it easier for engineers to handle a board 2 board distance tolerance of at least .078" (2.0 mm) without a spring, which is 300% more than the standard SMP! It features a 3° minimum tilt (radial travel) and it has an operating frequency range of DC-6 GHz and a 1.2 max VSWR guaranteed at DC-3 GHz.



SMP-MAX Adapter

Spring-loaded Connectors

Radiall's one connector IMP-Spring and three connector SMP-Spring and MMBX-Spring large misalignment spring-loaded series are the best for increased maximum distance tolerances.

IMP-Spring is a cost effective unique one connector solution that offers up to .023" (.6 mm) board 2 board distance tolerance with a tilt (radial travel) up to 4.5°.

The new SMP-Spring and MMBX-Spring offer up to .078" (2 mm) board 2 board distance tolerance and a 4.5° tilt (radial travel).

All spring-loaded solutions feature consistent VSWR and low RF leakage.



IMP-Spring and SMP-Spring



IMP

Limited Misalignment

Radiall's one connector IMP and three connector SMP and MMBX limited misalignment series are designed for applications requiring relatively precise distance tolerance of up to .023" (.6 mm) with a tilt (radial travel) of up to 4.5°.

No Misalignment

Radiall's MMT, MMS and MCX series are designed for applications requiring little or no distance tolerance between boards.

INTRODUCTION

MMBX/MCX

Family	Series	Misalignment tolerances		Dimensions		Performance		
		Angle tolerance (example with a 10mm distance between boards)	Board to board distance tolerance	Board to board minimum distance	PCB surface / size	Maximum frequency	Typical VSWR (min/max) at 3 GHz	Power at 3 GHz at 25°C
No misalignment	MMT	0	0	6.4 mm	4.2 X 4.9 / 25 mm ²	8 GHz	1,5	80W
	MMS	0	0	7.65 mm	4.2 X 5.1 / 21 mm ²	6 GHz	1,5	80W
	MCX	0	0	7.95 mm	6 X 6 / 36 mm ²	6 GHz	1,25	120W
Limited misalignment	IMP	0	0.4 mm	2 mm	4.5 X 4.5 / 20 mm ²	6 GHz	1,25	50 W
	SMP	3.5°/0.3mm Max	0.5 mm	9.5 mm	5 X 5 / 25 mm ²	12.4 GHz	1,12	120 W
	MMBX	4.5°/0.7mm Max	0.6 mm	6.7 mm	4 X 4 / 16 mm ²	6 GHz	1,15	150 W
Large misalignment Spring loaded	IMP-Spring	Not specified	1.2 mm	8.1 mm	∅ 7 / 38 mm ²	18 GHz	1,2	150 W
	IMP-Spring	1 ° / 1 mm Max	2.0 mm	16 mm	∅ 7 / 38 mm ²	6 GHz	1,15	150 W
	SMP-Spring	3.5°/0.3mm Max	1.2 mm	15.6 mm	5 X 5 / 25 mm ²	12.4 GHz	1,15	150 W
	MMBX-Spring	4.5°/0.7mm Max	1.6 mm	18 mm	6 X 6 / 36 mm ²	6 GHz	1,18	150 W
Large misalignment cost effective	SMP-Max	3°/1mm Min	2.0 mm Min	13 mm	5.6 X 5.6 / 31 mm ²	6 GHz	1,2	300 W at 2.7 GHz

INTRODUCTION



50Ω

DC - 12.4 GHz

GENERAL

- Snap-on mating
- Microminiature coaxial connectors
- Robust
- Surface mount receptacles
- Fully compatible with automated pick and place machines

APPLICATIONS

- Board to board applications
- Base station
- High density packaging

The MMBX™ connector series is particularly suitable for board to board connection in new generation telecommunication systems. MMBX™ connectors allow a quick connection in a minimum space requirement. Frequency range is DC to 12.4 GHz. SMT connectors are totally compatible with pick and place machines.

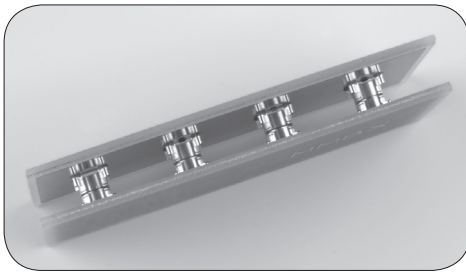

• Space saving

Its small space requirement is a main advantage for applications such as board to board connections as the height is only 7 mm.

• Series Range

Receptacles and in-series adapters can be either sold separately or with the in-series adapter already inserted in the receptacle. In this case, assembly time will be reduced and you will be sure that the in-series adapter is properly inserted, as it has to be assembled perpendicularly to the receptacle.

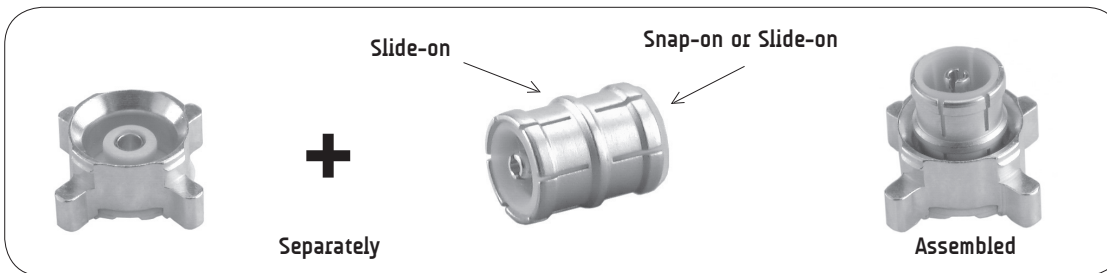

Retention between receptacle and in-series adapter is ensured by the design of the adapter.

- Slide-on/Snap-on: for board to board application, all in-series adapters remain on the same side during disconnection.
- Slide-on/Slide-on

In addition of PCB connectors and in-series adapters, Radiall offers you a wide range of products like straight plugs, right angle plugs and between-series adapters.

PCB connectors

PLUG

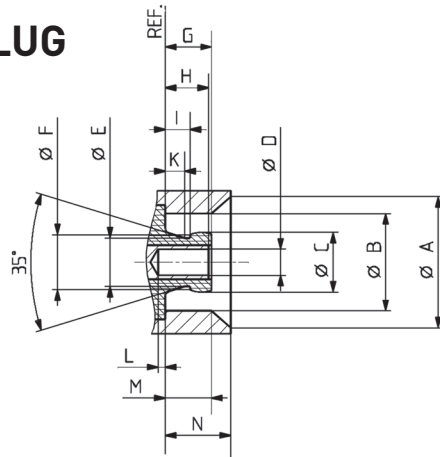

JACK

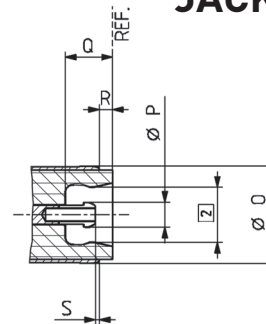

Letter	mm		inch	
	min.	max.	min.	max.
A	5.00 nom.	5.00 nom.	.197 nom.	.197 nom.
B	3.68	3.71	.145	.146
C	2.25	2.30	.088	.090
D	0.98	1.01	.038	.040
E	1.85 nom.	1.85 nom.	.073 nom.	.073 nom.
F	2.10 nom.	2.10 nom.	.083 nom.	.083 nom.
G		1.80		.071
H	1.55	1.75	.061	.069
I	0.90		.035	

Letter	mm		inch	
	min.	max.	min.	max.
K	0.75 nom.	0.75 nom.	.029 nom.	.029 nom.
L	0		0	
M	1.45		.057	
N	2.50 nom.	2.50 nom.	.098 nom.	.098 nom.
O	3.70 nom.	3.70 nom.	.146 nom.	.146 nom.
P	0.95 nom.	0.95 nom.	.037 nom.	.037 nom.
Q	1.85 nom.	1.85 nom.	.073 nom.	.073 nom.
R	0.50 nom.	0.50 nom.	.020 nom.	.020 nom.
S	0.10 nom.	0.10 nom.	.004 nom.	.004 nom.

In series adapters

Slide-on

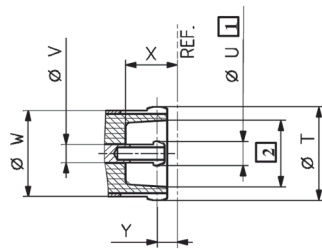

Snap-on

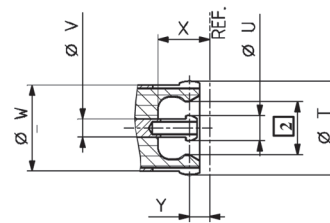

Letter	mm	inch
T	3.70 nom.	.146 nom.
U	0.95 nom.	.037 nom.
V	0.70 nom.	.027 nom.

Letter	mm	inch
W	3.65 nom.	.144 nom.
X	2.05 nom.	.080 nom.
Z	0.80 nom.	.031 nom.

- 1 Slotted and flared to meet electrical and mechanical requirements
- 2 Dimension to meet electrical and mechanical requirements

CHARACTERISTICS

Test/characteristics	CECC 22000	Values/remarks
----------------------	------------	----------------

ELECTRICAL CHARACTERISTICS

Impedance		50Ω		
Frequency range		DC - 12.4 GHz		
Typical V.S.W.R.		DC - 1 GHz	1 - 2.5 GHz	2.5 - 6 GHz
straight connectors: 2/50/S		1.05	1.06	1.10
2.6/50/S		1.05	1.06	1.10
2.6/50/D		1.05	1.06	1.10
right angle connectors: 2/50/S		1.05	1.13	1.22
2.6/50/S		1.05	1.06	1.17
2.6/50/D		1.05	1.06	1.13
Insulation resistance		> 1 GΩ		
Dielectric withstanding voltage	4.4.5	500 Vrms. 50 Hz		
(sea level) 2.50		750 Vrms. 50 Hz		
2.6/50				
Contact resistance		≤ 5 mΩ		
center contact	4.4.2	≤ 1 mΩ		
outer contact	4.4.3			

MECHANICAL CHARACTERISTICS

Mechanical endurance	4.7.1	100 matings
Engagement and separation force		30 N max
Engagement	4.5.4	8-30 N
Separation		
Contact captivation	4.5.2	≥ 10 N
Cable retention force		58 N
2/50		110 N
2.6/50		
Vibration	4.6.3 - IEC 68-2-6 Fc	MIL-STD-202, Method 204 D, condition A

ENVIRONMENTAL CHARACTERISTICS

Temperature range		-55°C + 155°C
Thermal shock	4.6.7 - IEC 68-2-14 Na	MIL STD 202, method 107G, condition B1
Moisture resistance	4.6.6 - IEC 68-2-3 Ca	MIL STD 202, method 106F
Corrosion	4.6.10 - IEC 68-2-11 Ka	MIL STD 202, method 101, condition B
Vibration	4.6.3 - IEC 68-2-6 Fc	MIL STD 202, method 204D, condition A

MATERIALS

Center & outer contacts		Beryllium copper
Bodies		Brass
Ferrules		Copper
Insulators		PTFE

PLATING

Center & outer contacts		Gold/NPGR
Bodies		NPGR
Ferrules		NPGR

All dimensions are given in mm.

Standard packaging = 100 pieces.

STRAIGHT PLUGS (male center contact)

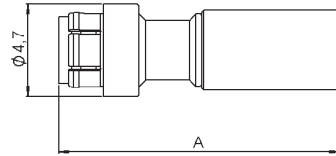
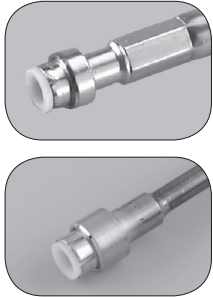

Fig. 1

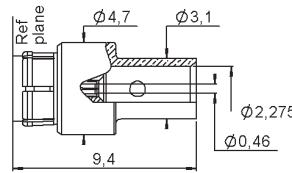

Fig. 2

Cable group	Cable group dia.	Part number	Fig.	A	Captive center contact	Note
RG178/RG196	2/50/S	R223 081 000	1	14.3	yes	Crimp type for flexible cables
RG174/RG316	2.6/50/S	R223 082 000	1	14.5		
RG316	2.6/50/D	R223 083 000	1			
RG405	.085"	R223 062 000	2			Solder type for semi-rigid cables

RIGHT ANGLE PLUGS (male center contact)

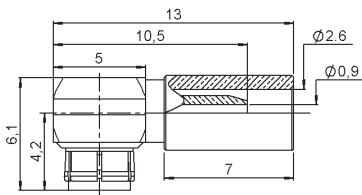
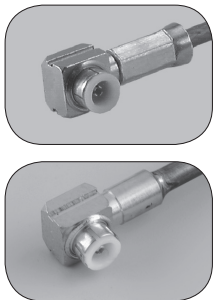

Fig. 1

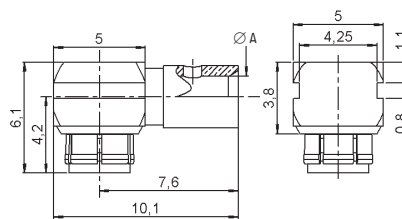

Fig. 2

Cable group	Cable group dia.	Part number	Fig.	A	Captive center contact	Note
RG178/RG196	2/50/S	R223 181 000	1		yes	Crimp type for flexible cables
RG174/RG316	2.6/50/S	R223 182 000	1			
RG316	2.6/50/D	R223 183 000	1			
RG405	.085"	R223 162 000	2	2.275		Solder type for semi-rigid cables

STRAIGHT PCB RECEPTACLES (male center contact)

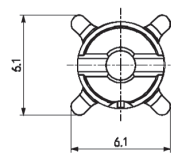

Fig. 1

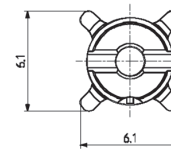
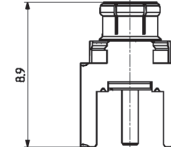
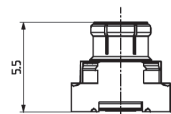

Fig. 2



Part number	Fig.	Captive center contact	PCB	Assembly instructions	Packaging	Note
R223 434 000	1	yes		M01	bulk 100 pieces	SMT
R223 434 800	1				tape & reel 720 pieces	
R223 435 000	2		P01		bulk 100 pieces	

To download data sheets and assembly instructions, visit www.radiall.com & enter the part number in the Search box. **Bold** part numbers represent products typically in stock & available for immediate shipment. See page 8 and 9 for packaging information.

PCB RECEPTACLES

EDGE CARD PCB RECEPTACLES (female center contact)

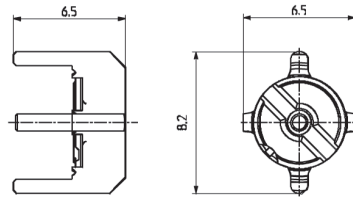
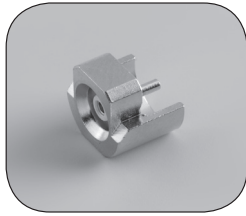

Fig. 1

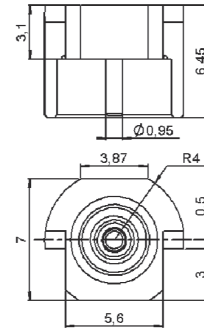

Fig. 2

Part number	Fig.	Captive center contact	Packaging	Note
R223 423 000	1	yes	bulk 100 pieces	SMT edge card
R223 423 010	2			

STRAIGHT PCB RECEPTACLES (female center contact)

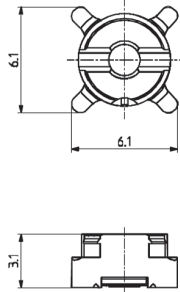
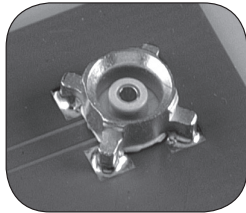

Fig. 1

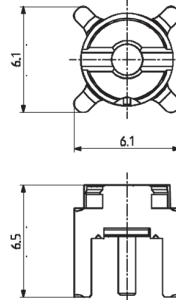

Fig. 2

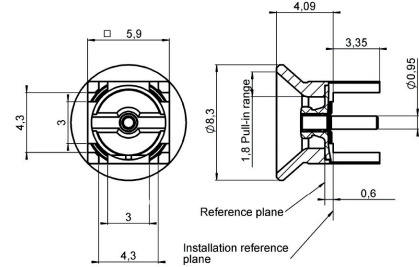
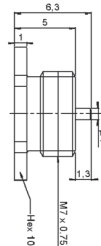
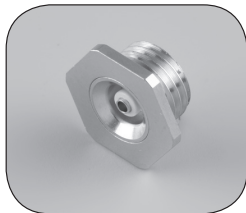

Fig. 3

Part number	Fig.	Captive center contact	PCB	Assembly instructions	Packaging	Note
R223 424 000	1	yes		M01	bulk 100 pieces	SMT
R223 424 800	1				tape & reel 720 pieces	
R223 425 000	2		P01		bulk 100 pieces	
R223 425 110	3		P01		bulk 100 pieces	

SCREW-ON RECEPTACLE (female center contact)



Part number	Captive center contact	Panel drilling
R223 555 000	yes	P03

To download data sheets and assembly instructions, visit www.radiall.com & enter the part number in the Search box.
Bold part numbers represent products typically in stock & available for immediate shipment.
 See page 8 and 9 for packaging information.

IN SERIES ADAPTERS (male-male center contact)

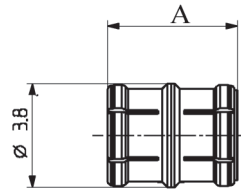
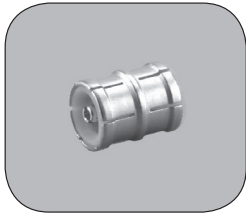

Part number	Length A (mm)	interface:	Nominal board to board
R223 703 000	4.8	snap-slide	6.7
R223 703 080	7.1	slide-slide	9

Other length can be designed upon request: minimum board to board height is 6.7 mm.

IN SERIES BULKHEAD ADAPTERS (male-male center contact)

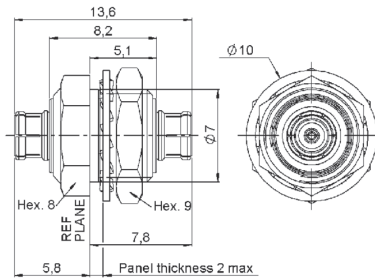

Part number	Series	Panel drilling
R223 720 020	MMBX male/MMBX male	P02

BETWEEN-SERIES ADAPTERS

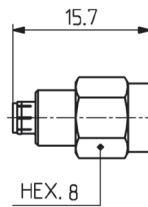

Fig. 1

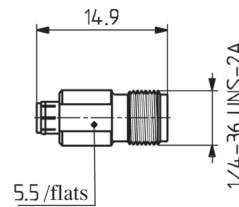

Fig. 2

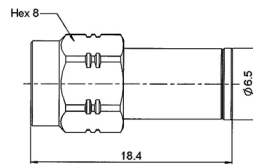

Fig. 3

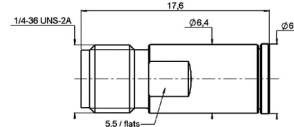

Fig. 4

Part number	Fig.	Series	Packaging
R191 389 100	1	MMBX male/SMA male	unit
R191 389 200	2	MMBX male/SMA female	
R191 389 300	3	MMBX female/SMA male	
R191 389 400	4	MMBX female/SMA female	

To download data sheets and assembly instructions, visit www.radiall.com & enter the part number in the Search box.
Bold part numbers represent products typically in stock & available for immediate shipment.
 See page 8 and 9 for packaging information.

DEMO BOARDS



Part number	Note
R223 990 000	2 SMT receptacles
R223 991 000	2 SMT receptacles with adapters

PANEL DRILLING

P01



	mm		inch	
	maxi	mini	maxi	mini
A	1.4	1.2	.055	.047
B	5.16	5	.203	.197

P02



	mm		inch	
	maxi	mini	maxi	mini
A	7.27	7.13	.283	.281

P03



	Threading
ØA	M7 x 0.75

RECEPTACLE PACKAGING

The tape is delivered on reels of 330 mm diameter

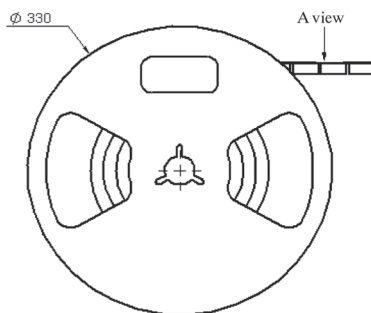

A VIEW

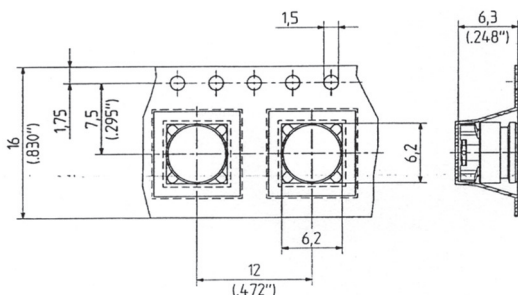

Part number	Note
R223 424 800	including 750 receptacles
R223 434 800	

M01

Part number			
R223 424 000	R223 424 800	R223 434 000	R223 434 800

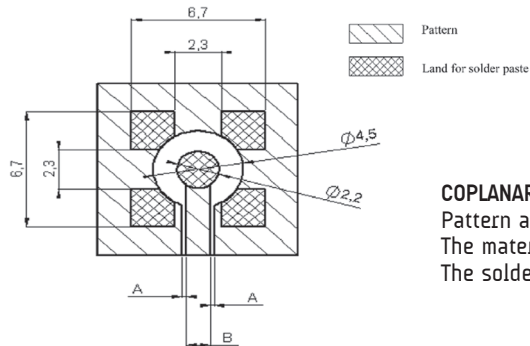

COPLANAR LINE

Pattern and signal are on the same side.

The material of PCB is epoxy resin (FR4) ($\epsilon_r = 4.6$).

The solder resist should be printed except for the land pattern on the PCB.

APPLICATION 75Ω WITH B = 0.55 mm

PCB thickness (mm)	Coplanar line A (mm)
0.8	0.350
1.0	0.360
1.2	0.365
1.6	0.375

APPLICATION 50Ω WITH B = 1.2 mm

PCB thickness (mm)	Coplanar line A (mm)
0.8	0.190
1.0	0.200
1.2	0.205
1.6	0.210

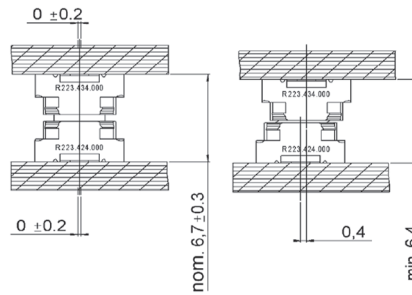
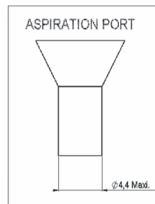
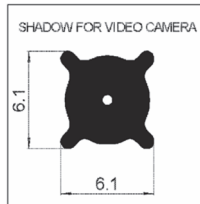

INTRODUCTION

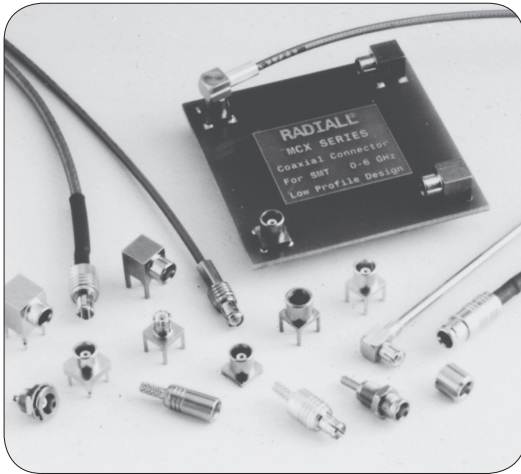

50Ω - 75Ω

DC - 6 GHz

GENERAL

- Subminiature coaxial connectors
- "Push-pull" snap-on mating
- Complies with specification CECC 22220
- CEI standard 1169-36

APPLICATIONS

50Ω models

- Wireless communications
- Civil and military radio-telecommunication equipment

75Ω models

- Videocommunication
- Television broadcasting

The MCX series utilizes the SMB series electrical line and features a particularly simple, compact and robust interface.

The MCX series is 30 % smaller than the SMB.

The MCX series helps to **miniaturize equipment**. It lowers wiring connection costs through its full crimp and solder crimp versions as the centre contact of the straight models can be either crimped or soldered. It optimizes PCB layouts with its range of models for PCBs including surface mount and press-fit receptacles.

INTERFACE

PLUG

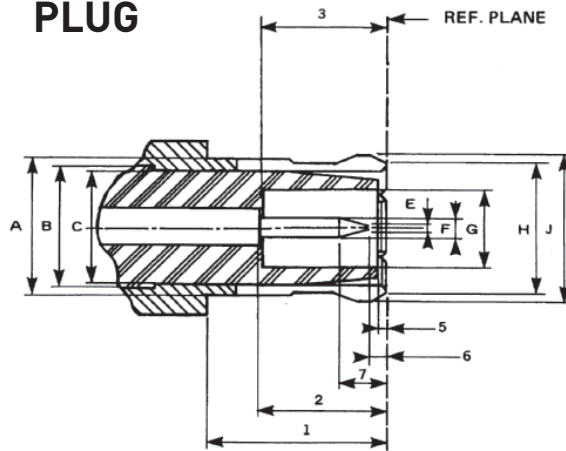

JACK

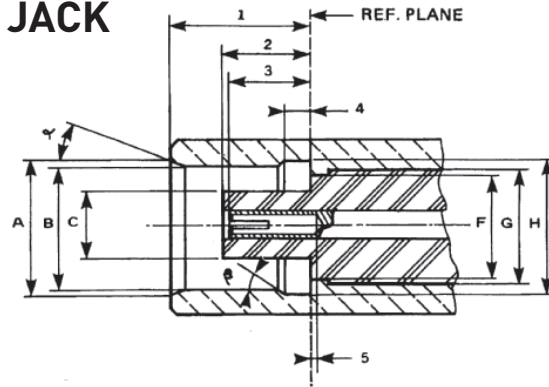

ITEM	mm		inch	
	min.	max.	min.	max.
1	4.15	-	.163	
2	2.80	3.20	.110	.126
3	2.80		.110	
5	0	0.30	0	.012
6	0.15		.006	
7		1.20		.047
A		3.40		.134
B	3.05 nom.		.120 nom.	
C		3.00		.118
E		0.25		.010
F	0.48	0.53	.019	.021
G	2.00		.079	
H		3.60		.142
J		3.80		.150

ITEM	mm		inch	
	min.	max.	min.	max.
1	4.00	4.12	.157	.162
2	2.60	2.80	.102	.110
3	2.30	2.80	.090	.110
4	0.75	0.85	.029	.033
5	0		0	
a	18°	22°	18°	22°
β	43°	47°	43°	47°
A	3.80		.150	
B	3.42	3.48	.135	.137
C		1.98		.078
F		3.00		.118
G	3.05 nom.		3.05 nom.	
H	3.60	3.75	.142	.148

Test/characteristics	Values/remarks
----------------------	----------------

ELECTRICAL CHARACTERISTICS

Impedance	50Ω and 75Ω		
Frequency range	DC - 6 GHz		
Typical V.S.W.R.	1 GHz	2.5 GHz	6 GHz
straight styles: .085	1.04	1.08	1.13
2.6/50/S	1.06	1.09	1.12
right angle styles: .085	1.03	1.06	1.10
2.6/50/S	1.04	1.07	1.10
Insulation resistance	1 000 MΩ		
Contact resistance (mΩ)	Initial	After environment	
center contact	≤ 5	≤ 15	
outer contact	≤ 2.5	≤ 7.5	
Voltage rating (V.R.M.R.)	At sea level	At 70.000 Ft	
• Cable RG 196/U - RG 188A/U - .047"	170 V rms max	45 V rms max	
• ∅ 2.6 double screen	335 V rms max	85 V rms max	
• RG 405/U - .085	250 V rms max	65 V rms max	
Dielectric withstanding voltage	At sea level	At 70.000 Ft	
• Cable RG 196/U - RG 188A/U - .047"	500 V rms max	100 V rms max	
• ∅ 2.6 double screen	750 V rms max	100 V rms max	
• RG 405/U - .085	750 V rms max	100 V rms max	
Power	P = 120W at 1.8 GHz, T = 40°C at sea level, VSWR = 1.1 for a straight plug MCX for ∅ 2.6/50/D cable		

MECHANICAL CHARACTERISTICS

Mechanical endurance	500 matings
Engagement	≤ 14.2 lbs - 63 N max
Separation force	≥ 1.8 Lbs - 8N ≤ 4.5 lbs 20 N
Cable retention force	RG 196A/U ≥ 7.2 lbs - 32 N RG 188A/U ≥ 11.9 lbs - 53 N ∅ 2.6/50 Ω double screen ≥ 24.1 lbs - 107 N .047" ≥ 9.7 lbs - 43 N RG 405/U-.085 ≥ 34.9 lbs - 155 N
Contact captivation	Axial force 2.25 Lbs 10 N

ENVIRONMENTAL CHARACTERISTICS

Operating temperature	-55°C +155°C	
Temperature cycling	CECC 22220 paragraph 4-6-5	
Thermal shock	CECC 22220 paragraph 4-6-7	MIL STD 202 - method 107 condition C
High temperature test	CECC 22220 paragraph 4-7-2	MIL STD 202 - method 108A condition D
Corrosion (salt spray)	CECC 22220 paragraph 4-6-10	MIL STD 202 - method 101 condition B
Vibration	CECC 22220 paragraph 4-6-3	MIL STD 202 - method 204 condition D

MATERIALS AND PLATING

	Materials	Platings
Bodies and male contacts	Brass	Gold/BBR (bodies)
Female center contacts	Beryllium copper	Gold
Ferrules	Brass	
Insulators	PTFE	

All dimensions are given in mm.

Standard packaging = 100 pieces.

CHARACTERISTICS

Test/characteristics	Values/remarks
----------------------	----------------

ELECTRICAL CHARACTERISTICS

Impedance	50Ω
Frequency range	DC - 6 GHz
Typical V.S.W.R. straight connectors	1.3
right angle connectors	1.35
Mating cycles	100
Temperature range	-40°C to +85°C

MATERIALS

Connector body	Brass
Insulator	PTFE
Female center contact	Bronze/Beryllium copper
Male center contact	Brass
Outer contact	Brass

PLATING AND PACKAGING

Body	Gold
Center contact	Gold
Outer contact	Gold
Female	Nickel
Packaging/MOQ	100 pieces bulk/MOQ 1000 pieces
	500 pieces reel/MOQ 1000 pieces
	unit packaging/MOQ 100 pieces

STRAIGHT PLUGS, FULL CRIMP TYPE, FOR FLEXIBLE CABLES

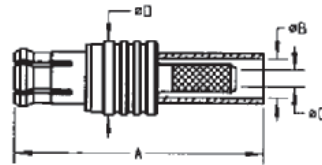
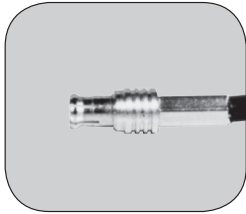

Cable group	Cable group dia.	Part number	Imp. (Ω)	Dimensions (mm)				Captive center contact	Finish
				A	B	C	D		
RG178/RG196	2/50/S	R113 081 000	50	16.1	2.55	1.1	5	no	Gold
RG174/RG316	2.6/50/S	R113 082 000		16.1	2.95	1.65		Gold	
		R113A 082 000		18.7	-	1.55		Gold ECO version	
		R113 083 000		16.2	3.25	1.65		Gold	
RD316	2.6/50/D	R113A 083 000		18.7	-	1.55		Gold ECO version	
RG179	2.6/75/S	R213 082 007	75	18.2	2.95	1.7	5.8	yes	BBR
RD179	2.6/75/D	R213 083 007		18.3	3.25				

STRAIGHT PLUGS, SOLDER TYPE, FOR SEMI-RIGID CABLES

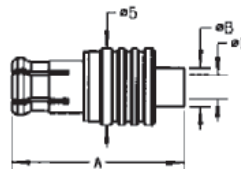
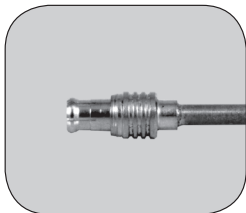

Cable group	Cable group dia.	Part number	Imp. (Ω)	Dimensions (mm)			Captive center contact	Finish
				A	B	C		
.047" semi-rigid	.047"	R113 051 000	50	11.3	2	1.3	no	Gold
RG405	.085"	R113 053 000			3	2.25		

RIGHT ANGLE PLUGS, CRIMP TYPE, FOR FLEXIBLE CABLES

(captive center contact)

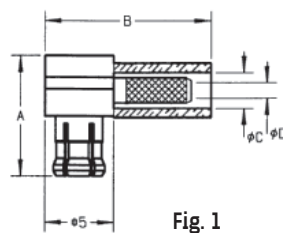
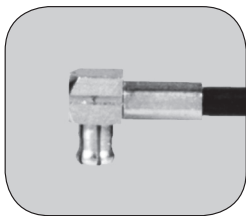

Fig. 1

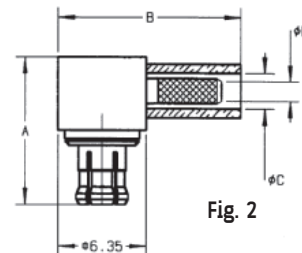

Fig. 2

Cable group	Cable group dia.	Part number	Fig.	Imp. (Ω)	Dimensions (mm)				Finish
					A	B	C	D	
RG178/RG196	2/50/S	R113 181 000	1	50	8.6	11.9	2.55	1.1	Gold
RG174/RG316	2.6/50/S	R113 182 000				11.9	2.95	1.65	Gold
		R113A 182 000			8.9	14.1	1.55	Gold ECO version	
		R113 183 000			8.6	11.9	3.25	1.65	Gold
RD316	2.6/50/D	R113A 183 000			8.9	14.1	1.55	Gold ECO version	
RG179	2.6/75/S	R213 182 007	2	75	10.6	13.3	2.95	1.7	BBR
RD179	2.6/75/D	R213 183 007					3.25		

To download data sheets and assembly instructions, visit www.radiall.com & enter the part number in the Search box. **Bold** part numbers represent products typically in stock & available for immediate shipment. See page 8 and 9 for packaging information.

PLUGS AND JACKS

RIGHT ANGLE PLUGS, SOLDER TYPE (captive center contact)

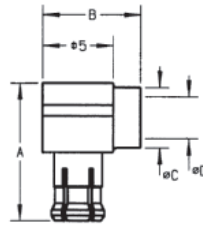
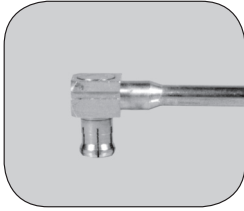

Cable group	Cable group dia.	Part number	Imp. (Ω)	Dimensions (mm)				Finish
				A	B	C	D	
.047" semi-rigid	.047"	R113 151 000	50	8.6	7	2.1	1.25	Gold
RG405	.085"	R113 153 000				3.1	2.25	
RG178/RG174/RG405	2/50/S - 2.6/50/S - .085"	R113 161 000		8	8	3.0	2.35	

STRAIGHT JACKS, FULL CRIMP TYPE, FOR FLEXIBLE CABLES

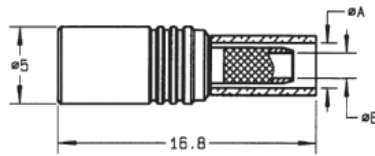

Fig. 1

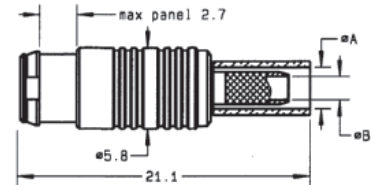
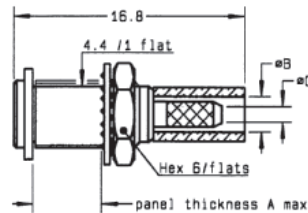
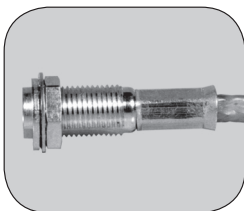

Fig. 2

Cable group	Cable group dia.	Part number	Fig.	Imp. (Ω)	Dimensions (mm)		Captive center contact	Panel drilling	Finish
					A	B			
RG178/RG196	2/50/S	R113 236 000	1	50	2.55	1.1	no		Gold
RG174/RG316	2.6/50/S	R113 240 000			2.95	1.65			
RG179	2.6/75/S	R213 238 007	2	75	2.95	1.7	yes	P01	BBR (Snap mount Panel thickness 2.5 ⁰ _{-0.1})

STRAIGHT BULKHEAD JACKS, FULL CRIMP TYPE, FOR FLEXIBLE CABLES



Cable group	Cable group dia.	Part number	Imp. (Ω)	Dimensions (mm)			Captive center contact	Panel drilling	Finish
				A	B	C			
RG178/RG196	2/50/S	R113 306 000	50	5	2.55	1.1	no	P02	Gold
RG174/RG316	2.6/50/S	R113 310 000			2.95	1.65			

To download data sheets and assembly instructions, visit www.radiall.com & enter the part number in the Search box. **Bold** part numbers represent products typically in stock & available for immediate shipment. See page 8 and 9 for packaging information.

STRAIGHT FEMALE PANEL RECEPTACLES (captive center contact)

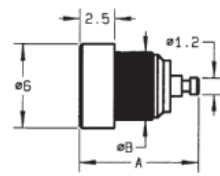
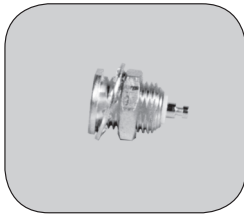

Fig. 1

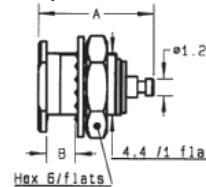
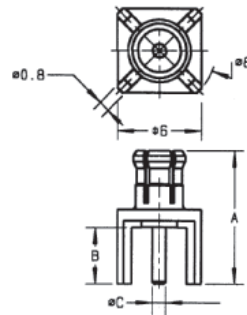
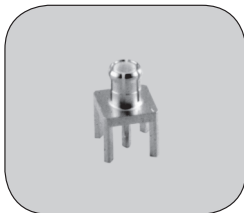

Fig. 2

Part number	Fig.	Imp. (Ω)	Dimensions (mm)		Panel drilling	Finish	Note
			A	B			
R113 402 220	1	50	8.7	4.8	P03	BBR	Press-in mount
R113 553 000	2		8.65	2.5	P02	Gold	Recessed front mount

STRAIGHT MALE PCB RECEPTACLES (captive center contact)



Part number	Imp. (Ω)	Dimensions (mm)			Panel drilling	Finish
		A	B	C		
R113 425 000	50	9.65	4.1	0.98	P05	Gold

STRAIGHT FEMALE PCB RECEPTACLES (captive center contact)

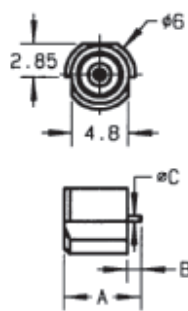

Fig. 1

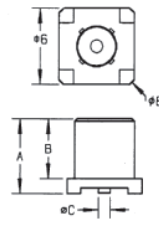

Fig. 2

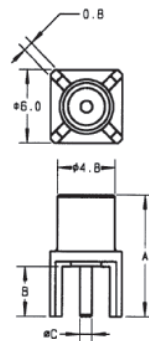

Fig. 3

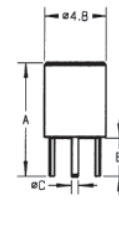

Fig. 4

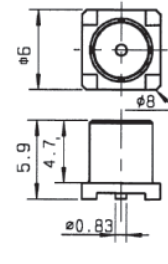

Fig. 5

Part number	Fig.	Imp. (Ω)	Dimensions (mm)			Assembly instructions	Panel drilling	Finish	Note		
			A	B	C						
R113 423 000	1	50	6.9	1.4	0.5	M01	P05	Gold	SMT/Edge-card		
R113 424 000	2		5.9	4.7	0.96				P06	BBR	SMT
R113 424 010											SMT/reel 100 pieces
R113 424 020											SMT/reel 500 pieces
R113A 424 020											SMT/reel 500 pieces ECO version
R113 426 000	3		10	4.1	0.98	P05	Gold	100 pieces ECO version			
R113A 426 000											
R113 426 020	4		9	3	0.5	P05	Gold	Space saving on PCB			
R113 427 000											
R213 426 000	3		75	10	4.1	0.71	P05	Gold	SMT/reel 100 pieces		
R213 424 800	5	M01									

To download data sheets and assembly instructions, visit www.radiall.com & enter the part number in the Search box.

Bold part numbers represent products typically in stock & available for immediate shipment.

See page 8 and 9 for packaging information.

RECEPTACLES AND IN SERIES ADAPTERS

RIGHT ANGLE FEMALE PCB RECEPTACLES (captive center contact)

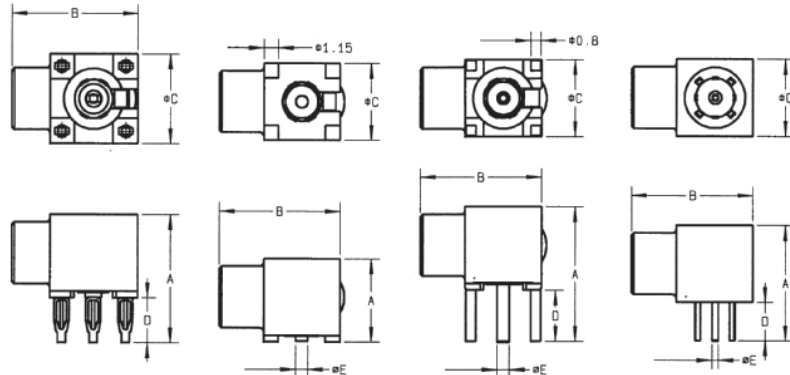

Fig. 1

Fig. 2

Fig. 3

Fig. 4

Part number	Fig.	Imp. (Ω)	Dimensions (mm)					Assembly instructions	Panel drilling	Finish	Note
			A	B	C	D	E				
R113 661 000	1	50	10	10	7	3.5			P04	Gold	Press-fit PCB mount
R113 664 000	2		6.5	9.5	6	0.96	M01				SMT
R113A 664 120	3		10.5							4	P05
R113 665 000			9	9.4	3	0.5	P06	BBR			
R113 665 020	3		6.5	9.5	6	0.83	M01			Gold	Space saving pattern
R113 666 000	4		10.5								4
R213 664 800	2	75	6.5	9.5	6	4	0.83			Gold	SMT/reel 100 pieces
R213 665 000	3		10.5								4

IN SERIES ADAPTERS (female - female)

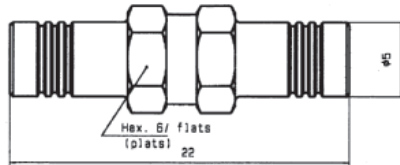

Part number	Imp. (Ω)	Finish
R113 704 000	50	Gold

To download data sheets and assembly instructions, visit www.radiall.com & enter the part number in the Search box.
Bold part numbers represent products typically in stock & available for immediate shipment.
 See page 8 and 9 for packaging information.

PANEL DRILLING



A	MM		INCH	
	maxi	mini	maxi	mini
A	5	4.97	0.197	0.196



	MM		INCH	
	maxi	mini	maxi	mini
A	5	4.9	0.197	0.19
B	4.58	4.46	0.18	0.176



A	MM		INCH	
	maxi	mini	maxi	mini
A	4.77	4.74	0.188	0.187

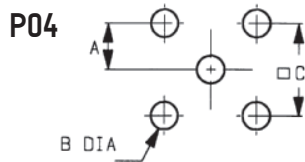

A	MM		INCH	
	maxi	mini	maxi	mini
A	2.565	2.515	0.101	0.1
B	1.09	0.94	0.043	0.037
C	5.105	5.055	0.201	0.199

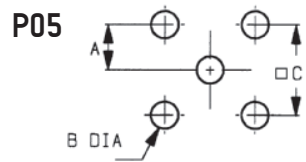

A	MM		INCH	
	maxi	mini	maxi	mini
A	2.56	2.52	0.101	0.099
B	1.4	1.3	0.055	0.051
C	5.13	5.03	0.202	0.198

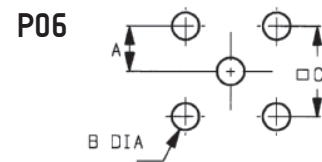

A	MM		INCH	
	maxi	mini	maxi	mini
A	1.30	1.24	.051	.049
B	0.89	0.79	.035	.031
C	2.59	2.49	.102	.098



A	MM		INCH	
	maxi	mini	maxi	mini
A	1.4	1.3	0.055	0.051
B	5.13	5.03	0.202	0.198

PACKAGING

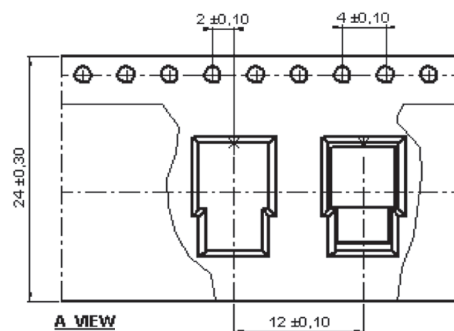
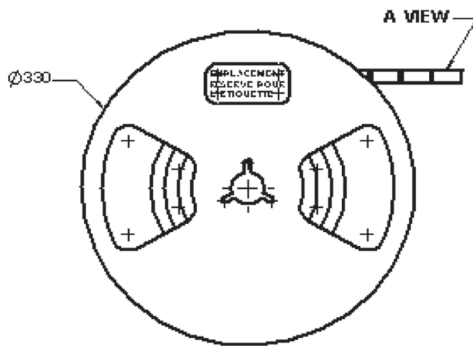

ASSEMBLY INSTRUCTIONS

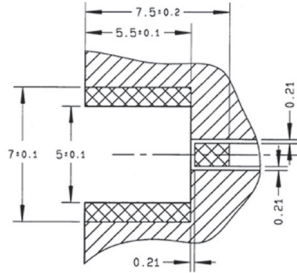

M01

Part number
R113 423 000

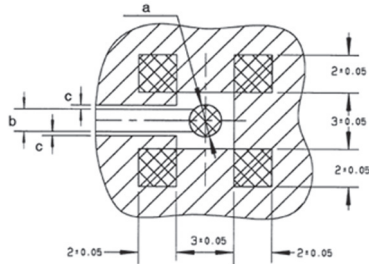

Part number	a	b	c
R113 424 000	Ø 1.7 ^{+0.1} ₀	1.2	0.21
R113A 424 020			
R113 424 010			
R113 424 020			
R113A 664 120	Ø 1.05	1.2	0.21
R213 424 800	Ø 1.57 ^{+0.1} ₀	1	0.63



-  Pattern
-  Land for solder paste

COPLANAR LINE

Pattern and signal are on the same side.
 Thickness of PCB: .063 (1.6 mm).
 The material of PCB is the epoxy resin of glass fabrics bacs (Er = 4.8).
 The solder resist should be printed

VIDEO SHADOW

Part number
R113 423 000

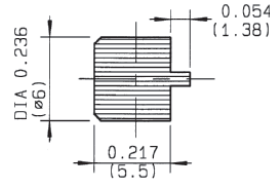

Part number	
R113 424 000	R113 424 020
R113 424 010	R113A 424 020
	R213 424 800

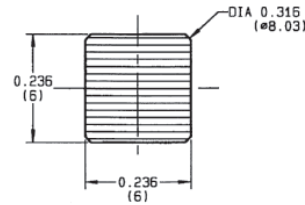

Part number	
R113 664 000	R213 664 800
	R113A 664 120

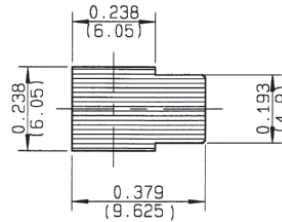

Vacuum nozzle dimensions

MCX 50Ω MCX 75Ω

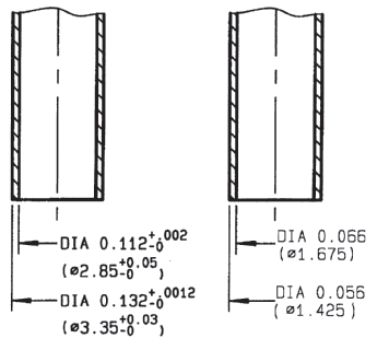

Cable designation	Cable Group Ø / Ω	Imp. Ω	Cable dimensions mm (inch)					Radiall cable if applicable		
			Core type	Core Ø	Insulator Ø	Screen	Outer Ø	P/N	Remark	
RG 174 A/U	2.6 / 50 S	50	7 x 0.16	0.48 (.019)	1.52 (.060)	S	2.79 (.110)	C291 150 000	PVC jacket	
RG 178 B/U	2 / 50 S	50	7 x 0.1	0.30 (.012)	0.84 (.033)	S	1.78 (.070)	C291 145 007	FEP jacket	
RG 178 B/U	2 / 50 S	50	7 x 0.1	0.30 (.012)	0.84 (.033)	S	1.83 (.072)	C291 145 060	PVC jacket	
RG178nonm.	2 / 50 S	50	7 x 0.1	0.29 (.011)	0.84 (.033)	S	1.80 (.071)	C291 140 087	non magnetic / FEP jacket	
RG 179 B/U	2.6 / 75 S	75	7 x 0.1	0.30 (.012)	1.60 (.063)	S	2.54 (.010)	C291 210 007	FEP jacket	
RG 187 A/U	2.6 / 75 S	75	7 x 0.1	0.30 (.012)	1.60 (.063)	S	2.79 (.110)	C291 211 006	PTFE jacket	
RG 188 A/U	2.6 / 50 S	50	7 x 0.17	0.51 (.020)	1.52 (.060)	S	2.79 (.110)	C291 160 006	PTFE jacket	
RG 196 A/U	2 / 50 S	50	7 x 0.1	0.30 (.012)	0.86 (.034)	S	2.03 (.080)	C291 110 006	PTFE jacket	
RG 212 /U	8 / 50 D	50	solid	1.41 (.056)	4.70 (.185)	D	8.43 (.331)	na		
RG 213 /U	10 / 50 S	50	7 x 0.75	2.26 (.089)	7.24 (.285)	S	10.30 (.406)	C291 510 000	PVC jacket	
RG 214 /U	11 / 50 D	50	7 x 0.75	2.25 (.089)	7.24 (.285)	D	10.80 (.425)	C291 600 000	PVC jacket	
RG 215	10 / 50 S	50	7 x 0.75	2.25 (.089)	7.25 (.285)	S	10.29 (.405)	na		
RG 216 /U	11 / 75 D	75	7 x 0.4	1.21 (.048)	7.24 (.285)	D	10.80 (.425)	C291 610 000	PVC jacket	
RG 217 /U	14 / 50 D	50	solid	2.69 (.106)	9.40 (.370)	D	13.84 (.545)	C291 620 000	PVC jacket	
RG 218 /U	22 / 50 S	50	solid	4.95 (.195)	17.27 (.680)	S	22.10 (.870)	C291 630 000	PVC jacket	
RG 223 /U	5 / 50 D	50	solid	0.89 (.035)	2.95 (.116)	D	5.38 (.212)	C291 330 000	PVC jacket	
RG 225 /U	11 / 50 D	50	7 x 0.8	2.38 (.094)	7.24 (.285)	D	10.90 (.429)	C291 605 007	glass fiber jacket	
RG 303 /U	5 / 50 S	50	solid	0.94 (.037)	2.95 (.116)	S	4.32 (.170)	na		
RG 316 /U	2.6 / 50 S	50	7 x 0.17	0.53 (.021)	1.52 (.060)	S	2.49 (.098)	C291 170 007	FEP jacket	
RD 316	2.6 / 50 D	50	7 x 0.17	0.53 (.021)	1.52 (.060)	D	2.80 (.110)	C291 185 067	FEP jacket	
RG 393	10 / 50 D	50	7 x 0.81	2.39 (.094)	7.24 (.285)	D	9.91 (.390)	C291 511 007	FEP jacket	
RG 400	5 / 50 / D	50	19 x 0.19	0.98 (.039)	2.95 (.116)	D	4.95 (.195)	C291 324 007	FEP jacket	
Flexible cable BT approved										
RD 179	2.6 / 75 D	75	7 x 0.10	0.30 (.012)	1.6 (.063)	D	3.07 (.121)	C291 230 080	LSOH jacket	
BT 3002	3.6 / 75 D	75	solid	0.31 (.012)	1.95 (.077)	D	3.55 (.140)	C291 246 046	FEP jacket	
BT 2002	5 / 75 D	75	7 x 0.20	0.60 (.024)	2.5 (.098)	D	5.1 (.200)	C291 333 080	FEP jacket	
Semi rigid cables MIL-C-17 standard										
RG 401 /U	.250"	50	solid	1.63 (.064)	5.31 (.209)	--	6.35 (.250)	C291 870 001	copper tubing	
RG 401 alu	.250"	50	solid	1.63 (.064)	5.31 (.209)	--	6.35 (.250)	C291 874 187	tinned alu tubing	
RG 402 /U	.141"	50	solid	0.92 (.036)	2.98 (.117)	--	3.58 (.141)	C291 860 001	copper tubing	
RG 402 tin	.141"	50	solid	0.92 (.036)	2.98 (.117)	--	3.58 (.141)	C291 862 005	tinned copper tubing	
RG402silver	.141"	50	solid	0.92 (.036)	2.98 (.117)	--	3.58 (.141)	C291 861 066	silvered copper tubing	
RG 402 alu	.141"	50	solid	0.92 (.036)	2.98 (.117)	--	3.58 (.141)	C291 864 187	tinned alu tubing	
RG402nonm.	.141"	50	solid	0.92 (.036)	2.98 (.117)	--	3.58 (.141)	C291 861 061	non magnetic / copper tubing	
RG 405 /U	.085"	50	solid	0.51 (.020)	1.68 (.066)	--	2.20 (.087)	C291 850 001	copper tubing	
RG 405 tin	.085"	50	solid	0.51 (.020)	1.68 (.066)	--	2.20 (.087)	C291 850 005	tinned copper tubing	
RG 405 alu	.085"	50	solid	0.51 (.020)	1.68 (.066)	--	2.20 (.087)	C291 844 187	tinned alu tubing	
RG405nonm.	.085"	50	solid	0.51 (.020)	1.68 (.066)	--	2.20 (.087)	C291 851 001	non magnetic / copper tubing	
.047"	.047"	50	solid	0.29 (.011)	0.94 (.037)	--	1.19 (.047)	C291 855 001	copper tubing	
.047" tin	.047"	50	solid	0.29 (.011)	0.94 (.037)	--	1.19 (.047)	C291 855 065	tinned copper tubing	
Hand-formable cable										
Hand-formable	.085"	50	solid	0.51 (.020)	1.63 (.064)	--	2.21 (.087)	C291 844 065	tin soaked braid	
Hand-formable	.141"	50	solid	0.92 (.036)	2.95 (.116)	--	3.50 (.138)	C291 864 065	tin soaked braid	
Hand-formable	.141"	50	solid	0.92 (.036)	2.98 (.117)	--	4.05 (.159)	C291 866 378	FEP jacket	
Hand-formable	.141"	50	solid	0.92 (.036)	2.98 (.117)	--	4.50 (.177)	C291 866 270	LSZH jacket	
Corrugated cables (with helical or ringed/annular copper tube)										
Flexible	1/4"	50	solid	2.38 (.094)	6.40 (.252)	--	8.70 (.343)	na	ringed/annular tube	
Flexible	1/2"	50	solid	4.80 (.189)	11.6 (.457)	--	16.35 (.644)	C291 972 085	ringed/annular tube	
Flexible	7/8"	50	solid	9.13 (.359)	22.5 (.866)	--	27.7 (1.091)	na	ringed/annular tube	
Flexible	1 1/4"	50	solid	12.7 (.500)	32.5 (1.28)	--	39.5 (1.55)	na	ringed/annular tube	
Flexible	1 5/8"	50	solid	17.3 (.681)	43.5 (1.71)	--	50.5 (1.99)	na	ringed/annular tube	
Super flexible	1/4"	50	solid	1.90 (.075)	4.70 (.185)	--	7.40 (.291)	C291 993 080	helical tube	
Super flexible	3/8"	50	solid	2.60 (.102)	6.30 (.248)	--	10.8 (.425)	C291 996 070	helical tube	
Super flexible	1/2"	50	solid	3.60 (.142)	8.70 (.343)	--	13.2 (.520)	C291 994 080	helical tube	
Super flexible	7/8"	50	tube	9.04 (.356)	23.62 (.930)	--	27.48 (1.082)	C291 996 580	helical tube	

Note: S = single braid. D = dual braid.

For more information about cables manufactured by Radiall, please consult our online catalog.

www.radiall.com

X-ON Electronics

Largest Supplier of Electrical and Electronic Components

Click to view similar products for [RF Adapters - In Series](#) category:

Click to view products by [Radiall](#) manufacturer:

Other Similar products are found below :

[5916-1103-603](#) [5919-1503-000](#) [651A505](#) [82-5552](#) [9030-9523-502](#) [PN2C](#) [A0407000](#) [R114703000W](#) [R125771001](#) [R127871001](#)
[R141710000W](#) [R141723161](#) [R141730000](#) [R143730700](#) [R143770000](#) [R161703000W](#) [R161753000W](#) [R161791530W](#) [R201705000](#)
[R222705200](#) [R222M40010W](#) [R223703180](#) [R316754000](#) [R405006000](#) [R443162000](#) [AD78TL](#) [HRM-513S](#) [1996352-2](#) [2157155-1](#) [252169-75](#)
[AD158](#) [2101130-1](#) [252186](#) [R114704000W](#) [R114720000W](#) [R125705001](#) [R125705701](#) [R125771000](#) [R125771001W](#) [R127704001](#)
[R127.870.001](#) [R127872001](#) [R141717000](#) [R142710000](#) [R142723000](#) [R143703000](#) [R143704000](#) [R143705700](#) [R161771000W](#) [R176754000](#)