

PAGE 1/2	ISSUE 09-04-20B	SERIES ATTENUATOR	PART NUMBER R412519124
----------	------------------------	-----------------------------	-------------------------------

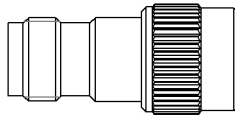

SCALE 1 : 1

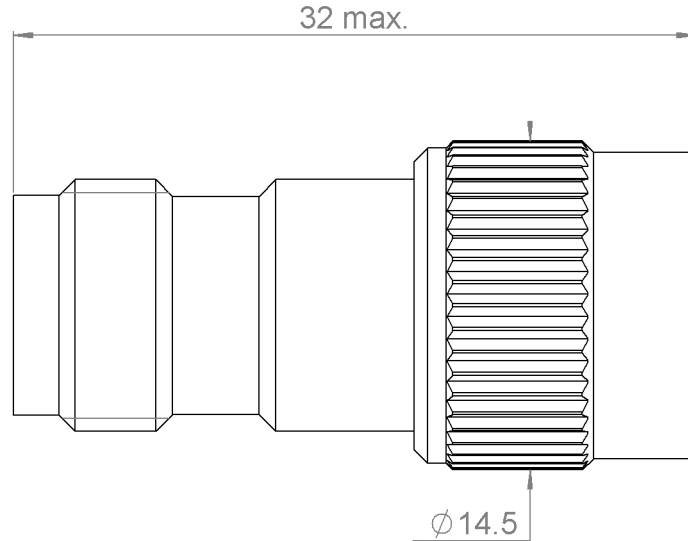
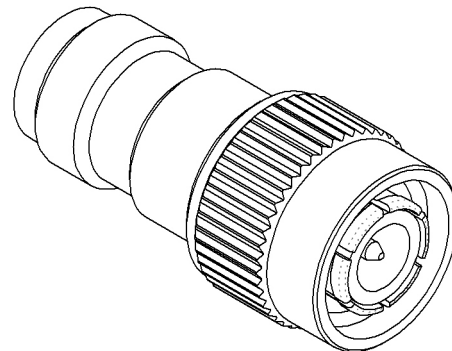

All dimensions are in mm. Tolerances according ISO 2768 m-H

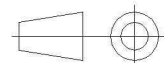

COMPONENTS	MATERIALS	PLATING (µm)
Body	BRASS	NICKEL 2
Male center contact	BRASS	GOLD 1 OVER NICKEL 2
Female center contact	BERYLLIUM COPPER	GOLD 1 OVER NICKEL 2
Outer contact		
Insulator	PTFE	
Gasket	SILICONE RUBBER	
Substrate	ALUMINA	
Resistor	THICK FILM	
Others parts		

PAGE 2/2	ISSUE 09-04-20B	SERIES ATTENUATOR	PART NUMBER R412519124
----------	------------------------	-----------------------------	-------------------------------

ELECTRICAL CHARACTERISTICS

Frequency (GHz)	DC - 2	2 - 3
V.S.W.R (\leq)	1.20	1.30
Deviation(\pm dB)	1.0	1.0

Operating Frequency Range	DC - 3	GHz
Impedance	50	Ω
Nominal Attenuation	19	dB
Peak power at 25°C (1 μ s, 1%)	100	W
Average power at 25°C	1	W (Free Air Cooled)
		W (Conduction Cooled)

MECHANICAL CHARACTERISTICS

Connectors	TNC	Male Female	MIL-C 39012
Weight	16,77 g		

ENVIRONMENTAL CHARACTERISTICS

Operating temperature range	-40 / +85 °C
Storage temperature range	-40 / +85 °C

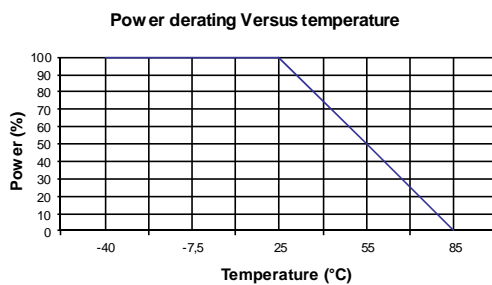
SPECIFICATION
OTHER CHARACTERISTICS

X-ON Electronics

Largest Supplier of Electrical and Electronic Components

Click to view similar products for [Attenuators - Interconnects](#) category:

Click to view products by [Radiall](#) manufacturer:

Other Similar products are found below :

[R411803119](#) [R413806115](#) [R413808000](#) [R413810115](#) [R413850115](#) [R414510000](#) [R414701000](#) [BNC-13](#) [R411800121](#) [R411801121](#)
[R412412124](#) [R412450000](#) [R413800000](#) [R413805000](#) [R413830000](#) [R413840115](#) [R414730000](#) [R415420000](#) [R415703000](#) [R416010000](#)
[R420003110](#) [R411801000](#) [R411815121](#) [R413305000](#) [R413801000](#) [R414520000](#) [R411808121](#) [R412500124](#) [R412414124](#) [R412501124](#)
[HMC-C584](#) [R413802000](#) [R412400124](#) [R411700124](#) [R417310130](#) [R411801119](#) [R412419124](#) [R411703124](#) [R412401124](#) [R443131000](#)
[R417130110](#) [R414700000](#) [R414505000](#) [R411802119](#) [R417720128](#) [R420706110](#) [R413811000](#) [R413803115](#) [R414501000](#) [R417903128](#)