

N ATTENUATOR
6 DB 6 GHZ 1W

R412.706.124
Series : ATTENUATOR

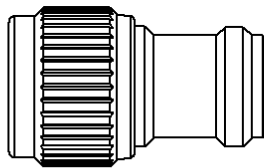

scale 1/1

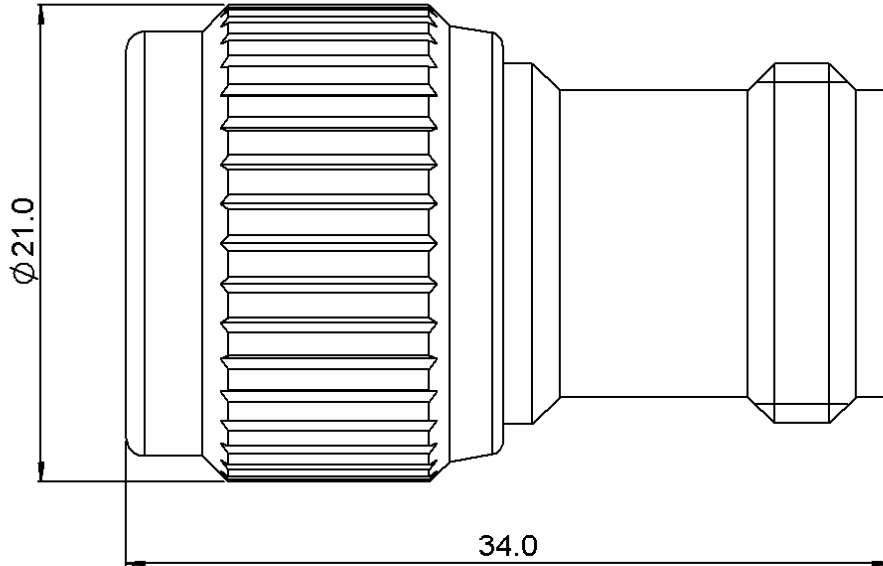
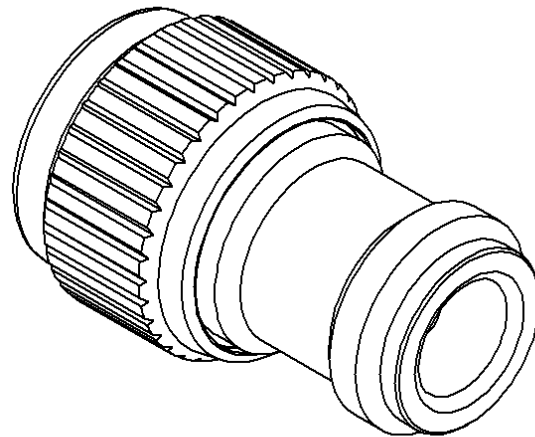

All dimensions are in mm.



COMPONENTS	MATERIALS	PLATING(µm)
BODY	BRASS	NICKEL 2
MALE CENTER CONTACT	BRASS	GOLD 1 OVER NICKEL 2
FEMALE CENTER CONTACT	BERYLLIUM COPPER	GOLD 1 OVER NICKEL 2
OUTER CONTACT		
INSULATOR	PTFE	
GASKET	SILICONE RUBBER	
SUBSTRATE	ALUMINA	
RESISTOR	THICK FILM	
OTHERS PARTS		

Issue : 0828 B

In the effort to improve our products, we reserve the right to make changes judged to be necessary.

N ATTENUATOR
6 DB 6 GHZ 1W

R412.706.124
Series : ATTENUATOR

ELECTRICAL CHARACTERISTICS

Frequency (GHz)	DC - 2	2 - 6
V.S.W.R (≤)	1.20	1.30
Deviation(±dB)	0.30	0.50

Operating Frequency Range	DC - 6	GHz
Impedance	50	Ω
Nominal Attenuation	6	dB
Peak power at 25°C (1μs, 1%)	100	W
Average power at 25°C	1	W (Free Air Cooled)
		W (Conduction Cooled)

MECHANICAL CHARACTERISTICS

Connectors	N	Male Female	MIL-C 39012
Weight	42,6600 g		

ENVIRONMENTAL CHARACTERISTICS

Operating temperature range	-40 / +85 °C
Storage temperature range	-40 / +85 °C

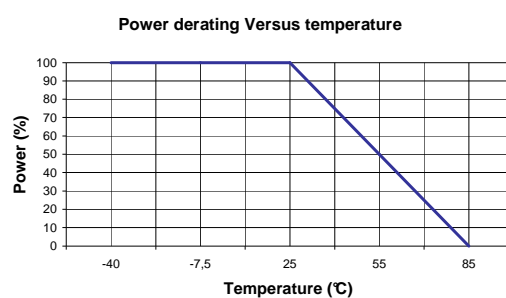

SPECIFICATION

OTHER CHARACTERISTICS

Issue : 0828 B

In the effort to improve our products, we reserve the right to make changes judged to be necessary.



X-ON Electronics

Largest Supplier of Electrical and Electronic Components

Click to view similar products for [Attenuators - Interconnects](#) category:

Click to view products by [Radiall](#) manufacturer:

Other Similar products are found below :

[R411803119](#) [R413806115](#) [R413808000](#) [R413810115](#) [R413850115](#) [R414510000](#) [R414701000](#) [BNC-13](#) [R411800121](#) [R411801121](#)
[R412412124](#) [R412450000](#) [R413800000](#) [R413805000](#) [R413830000](#) [R413840115](#) [R414730000](#) [R415420000](#) [R415703000](#) [R416010000](#)
[R420003110](#) [R411801000](#) [R411815121](#) [R413305000](#) [R413801000](#) [R414520000](#) [R411808121](#) [R412500124](#) [R412414124](#) [R412501124](#)
[HMC-C584](#) [R413802000](#) [R412400124](#) [R411700124](#) [R417310130](#) [R411801119](#) [R412419124](#) [R411703124](#) [R412401124](#) [R443131000](#)
[R417130110](#) [R414700000](#) [R414505000](#) [R411802119](#) [R417720128](#) [R420706110](#) [R413811000](#) [R413803115](#) [R414501000](#) [R417903128](#)