

PAGE 1/2	ISSUE 26-03-18B	SERIES ATTENUATOR	PART NUMBER R413806150
----------	-----------------	-----------------------------	-------------------------------

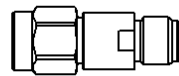

Scale 1:1

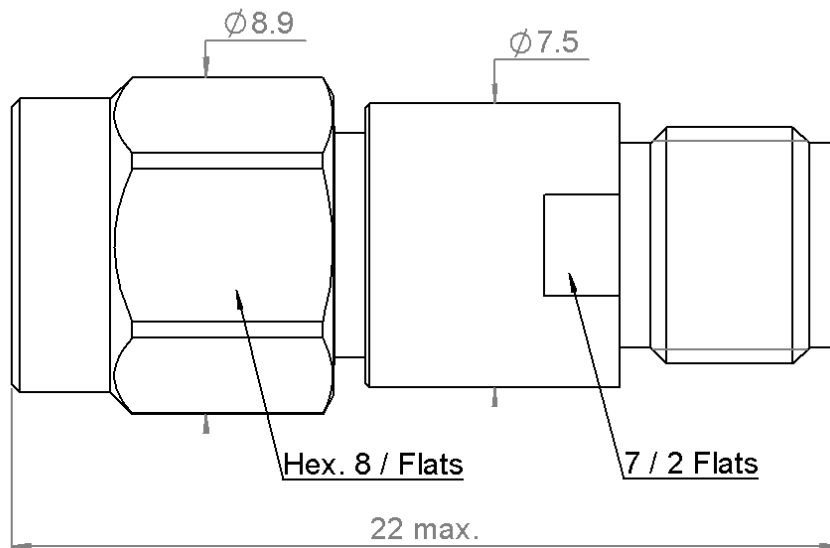
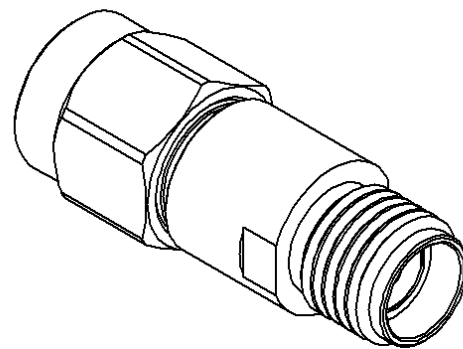

All dimensions are in mm. Tolerances according ISO 2768 m-H

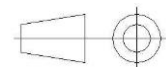

COMPONENTS	MATERIALS	PLATING (μm)
Body	STAINLESS STEEL	PASSIVATED
Male center contact	BERYLLIUM COPPER	GOLD OVER NICKEL
Female center contact	BERYLLIUM COPPER	GOLD OVER NICKEL
Outer contact	STAINLESS STEEL	PASSIVATED
Insulator	PTFE	
Gasket	SILICONE RUBBER	
Substrate	ALUMINA CERAMIC	
Resistor	THIN FILM	
Others parts	STAINLESS STEEL	PASSIVATED

PAGE 2/2	ISSUE 26-03-18B	SERIES ATTENUATOR	PART NUMBER R413806150
----------	------------------------	-----------------------------	-------------------------------

ELECTRICAL CHARACTERISTICS

Frequency (GHz)	DC - 4	4 - 8	8 - 12.4	12.4 - 18	18 - 23
V.S.W.R (≤)	1.1	1.15	1.2	1.25	1.3
Deviation(±dB)	0.3	0.3	0.3	0.3	0.4

Operating Frequency Range	DC - 23	GHz
Impedance	50	Ω
Nominal Attenuation	6	dB
Peak power at 25°C (1μs, 1%)	50	W
Average power at 25°C	2	W (Free Air Cooled)
		W (Conduction Cooled)

MECHANICAL CHARACTERISTICS

Connectors	SMA	Male Female	MIL-C 39012
Weight	4,7000 g		

ENVIRONMENTAL CHARACTERISTICS

Operating temperature range	-55/+125 °C
Storage temperature range	-55/+125 °C

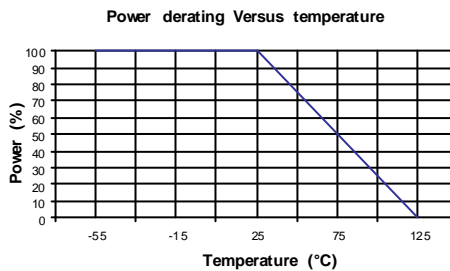
SPECIFICATION
OTHER CHARACTERISTICS

X-ON Electronics

Largest Supplier of Electrical and Electronic Components

Click to view similar products for [Attenuators - Interconnects](#) category:

Click to view products by [Radiall](#) manufacturer:

Other Similar products are found below :

[R411803119](#) [R413806115](#) [R413808000](#) [R413810115](#) [R413850115](#) [R414510000](#) [R414701000](#) [R415303000](#) [BNC-13](#) [R411800121](#)
[R411801121](#) [R412412124](#) [R412450000](#) [R413800000](#) [R413805000](#) [R413830000](#) [R413840115](#) [R414730000](#) [R415420000](#) [R415703000](#)
[R416010000](#) [R420003110](#) [R411801000](#) [R411815121](#) [R413305000](#) [R413801000](#) [R414520000](#) [R411808121](#) [R412500124](#) [R412414124](#)
[R412501124](#) [HMC-C584](#) [R413802000](#) [R412400124](#) [R411700124](#) [R417310130](#) [R411801119](#) [R412419124](#) [R411703124](#) [R412401124](#)
[R443131000](#) [R417130110](#) [R414700000](#) [R414505000](#) [R411802119](#) [R417720128](#) [R420706110](#) [R413811000](#) [R413803115](#) [R414501000](#)