

PAGE 1/2	ISSUE 17-07-15A	SERIES ATTENUATOR	PART NUMBER R414430150
----------	-----------------	----------------------	-------------------------------

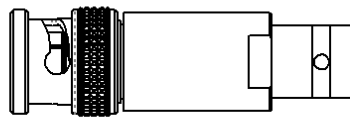

Scale 1:1

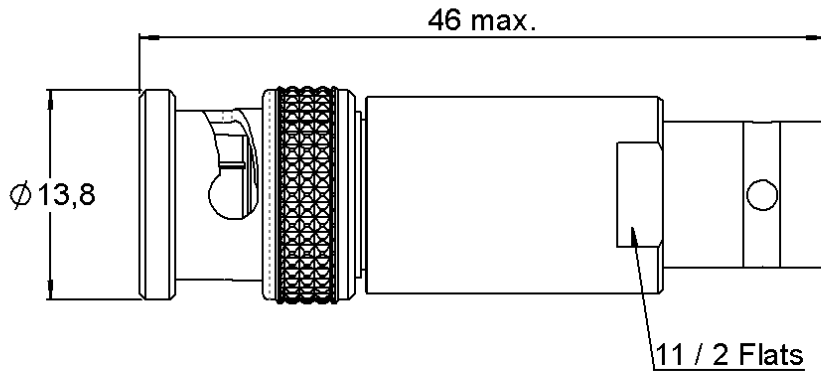
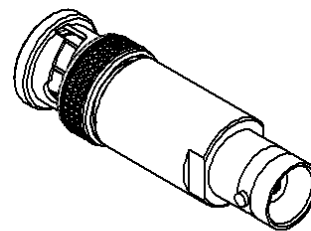

All dimensions are in mm.

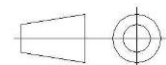

COMPONENTS	MATERIALS	PLATING (μm)
Body	STAINLESS STEEL	PASSIVATED
Male center contact	BERYLLIUM COPPER	GOLD OVER NICKEL
Female center contact	BERYLLIUM COPPER	GOLD OVER NICKEL
Outer contact	BRASS	NICKEL
Insulator	PTFE	
Gasket	SILICONE RUBBER	
Substrate	ALUMINA CERAMIC	
Resistor	THIN FILM	
Others parts	-	-

PAGE 2/2	ISSUE 17-07-15A	SERIES ATTENUATOR	PART NUMBER R414430150
----------	-----------------	-----------------------------	-------------------------------

ELECTRICAL CHARACTERISTICS

Frequency (GHz)	DC - 2	2 - 4
V.S.W.R (≤)	1.08	1.15
Deviation(±dB)	0.4	0.4

Operating Frequency Range	DC - 4	GHz
Impedance	50	Ω
Nominal Attenuation	30	dB
Peak power at 25°C (1μs, 1%)	50	W
Average power at 25°C	2	W (Free Air Cooled)
		W (Conduction Cooled)

MECHANICAL CHARACTERISTICS

Connectors	BNC	Male Female	MIL-C 39012
Weight	26,9000 g		

ENVIRONMENTAL CHARACTERISTICS

Operating temperature range	-55/+125 °C
Storage temperature range	-55/+125 °C

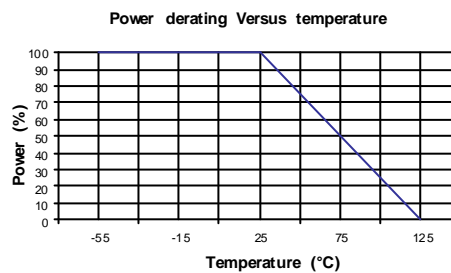

SPECIFICATION

OTHER CHARACTERISTICS

X-ON Electronics

Largest Supplier of Electrical and Electronic Components

Click to view similar products for [Attenuators - Interconnects](#) category:

Click to view products by [Radiall](#) manufacturer:

Other Similar products are found below :

[R411803119](#) [R413806115](#) [R413808000](#) [R413810115](#) [R413850115](#) [R414510000](#) [R414701000](#) [BNC-13](#) [R411800121](#) [R411801121](#)
[R412412124](#) [R412450000](#) [R413800000](#) [R413805000](#) [R413830000](#) [R413840115](#) [R414730000](#) [R415420000](#) [R415703000](#) [R416010000](#)
[R420003110](#) [R411801000](#) [R411815121](#) [R413305000](#) [R413801000](#) [R414520000](#) [R411808121](#) [R412500124](#) [R412414124](#) [R412501124](#)
[HMC-C584](#) [R413802000](#) [R412400124](#) [R411700124](#) [R417310130](#) [R411801119](#) [R412419124](#) [R411703124](#) [R412401124](#) [R443131000](#)
[R417130110](#) [R414700000](#) [R414505000](#) [R411802119](#) [R417720128](#) [R420706110](#) [R413811000](#) [R413803115](#) [R414501000](#) [R417903128](#)