

N ATTENUATOR
13 DB 12.4 GHZ 2W

R414.713.000

Series : ATTENUATOR

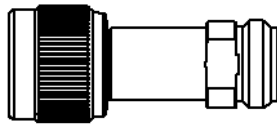
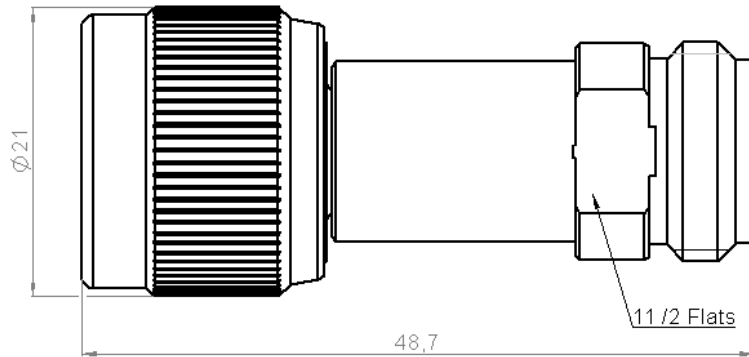

SCALE 1/1

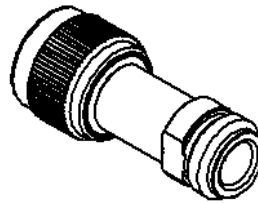

All dimensions are in mm.

COMPONENTS	MATERIALS	PLATING(μm)
BODY	LAITON	NICKEL 5
MALE CENTER CONTACT	CUPRO BERYLLIUM	OR 2.5 SUR NICKEL 1
FEMALE CENTER CONTACT	CUPRO BERYLLIUM	OR 2.5 SUR NICKEL 1
OUTER CONTACT		
INSULATOR	PTFE	
GASKET	ELASTOMERE SILICONE	
SUBSTRATE	ALUMINE	
RESISTOR	Couche mince	
OTHERS PARTS		

Issue : 0823 C

In the effort to improve our products, we reserve the right to make changes judged to be necessary.

N ATTENUATOR
13 DB 12.4 GHZ 2W

R414.713.000
 Series : ATTENUATOR

ELECTRICAL CHARACTERISTICS

Frequency (GHz)	DC - 4	4 - 8	8 - 12.4	
V.S.W.R (≤)	1.15	1.20	1.25	
Deviation(±dB)	0.30	0.50	0.70	
Operating Frequency Range	DC - 12.4			GHz
Impedance	50			Ω
Nominal Attenuation	13			dB
Peak power at 25°C (1μs, 1%)	100			W
Average power at 25°C	2			W (Free Air Cooled) W (Conduction Cooled)

MECHANICAL CHARACTERISTICS

Connectors N Male Female MIL-C 39012
 Weight 59,6200 g

ENVIRONMENTAL CHARACTERISTICS

Operating temperature range -55 /+125 °C
 Storage temperature range -55 /+125 °C

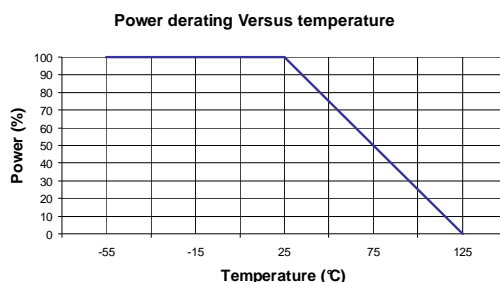

SPECIFICATION

OTHER CHARACTERISTICS

Issue : 0823 C

In the effort to improve our products, we reserve the right to make changes judged to be necessary.

X-ON Electronics

Largest Supplier of Electrical and Electronic Components

Click to view similar products for [Attenuators - Interconnects](#) category:

Click to view products by [Radiall](#) manufacturer:

Other Similar products are found below :

[R411803119](#) [R413806115](#) [R413808000](#) [R413810115](#) [R413850115](#) [R414510000](#) [R414701000](#) [BNC-13](#) [R411800121](#) [R411801121](#)
[R412412124](#) [R412450000](#) [R413800000](#) [R413805000](#) [R413830000](#) [R413840115](#) [R414730000](#) [R415420000](#) [R415703000](#) [R416010000](#)
[R420003110](#) [R411801000](#) [R411815121](#) [R413305000](#) [R413801000](#) [R414520000](#) [R411808121](#) [R412500124](#) [R412414124](#) [R412501124](#)
[HMC-C584](#) [R413802000](#) [R412400124](#) [R411700124](#) [R417310130](#) [R411801119](#) [R412419124](#) [R411703124](#) [R412401124](#) [R443131000](#)
[R417130110](#) [R414700000](#) [R414505000](#) [R411802119](#) [R417720128](#) [R420706110](#) [R413811000](#) [R413803115](#) [R414501000](#) [R417903128](#)