

PAGE 1/2	ISSUE 22-03-16B	SERIES ATTENUATOR	PART NUMBER R417030130
----------	------------------------	-----------------------------	-------------------------------

SCALE 1 : 2

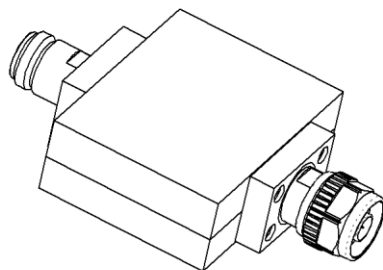

All dimensions are in mm.

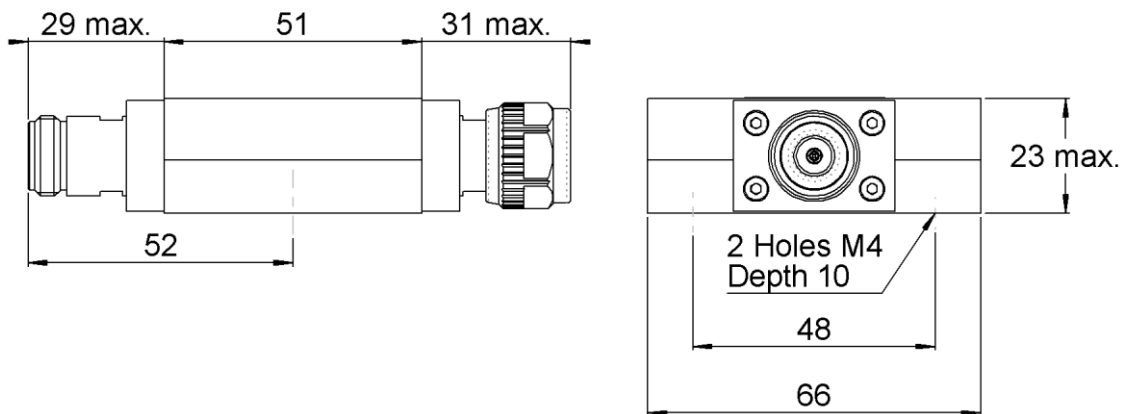
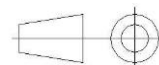

COMPONENTS	MATERIALS	PLATING (µm)
Body	STAINLESS STEEL	PASSIVATED
Male center contact	BERYLLIUM COPPER	GOLD 0.5 OVER NICKEL PHOSPHORUS 2
Female center contact	BERYLLIUM COPPER	GOLD 0.5 OVER NICKEL PHOSPHORUS 2
Outer contact	-	-
Insulator	PTFE	
Gasket	SILICONE RUBBER	
Substrate	ALUMINA	
Resistor	THICK FILM	
Others parts	ALUMINIUM	BLACK PAINTING

PAGE 2/2	ISSUE 22-03-16B	SERIES ATTENUATOR	PART NUMBER R417030130
----------	------------------------	-----------------------------	-------------------------------

ELECTRICAL CHARACTERISTICS

Frequency (GHz)	DC - 1	1 - 2	2 - 3
V.S.W.R (≤)	1.10	1.25	1.35
Deviation(±dB)	2.00	2.00	2.00

Operating Frequency Range	DC - 3	GHz
Impedance	50	Ω
Nominal Attenuation	30	dB
Peak power at 25°C (1μs, 1%)	5000	W
Average power at 25°C		W (Free Air Cooled)
	50	W (Conduction Cooled)
For conduction cooling, a plate 500 cm2 x 3 mm(78 sq.in*1/8) min. is required		

MECHANICAL CHARACTERISTICS

Connectors	N	Male Female	MIL-C 39012
Weight	290,4100	g	

ENVIRONMENTAL CHARACTERISTICS

Operating temperature range	-55 /+125	°C
Storage temperature range	-55 /+125	°C

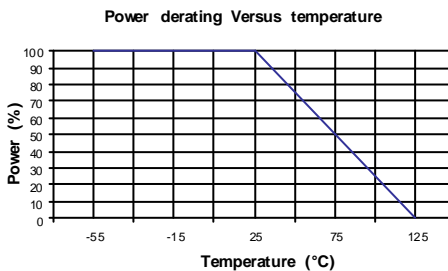

SPECIFICATION

OTHER CHARACTERISTICS

X-ON Electronics

Largest Supplier of Electrical and Electronic Components

Click to view similar products for [Attenuators - Interconnects](#) category:

Click to view products by [Radiall](#) manufacturer:

Other Similar products are found below :

[R411803119](#) [R413806115](#) [R413808000](#) [R413810115](#) [R413850115](#) [R414510000](#) [R414701000](#) [BNC-13](#) [R411800121](#) [R411801121](#)
[R412412124](#) [R412450000](#) [R413800000](#) [R413805000](#) [R413830000](#) [R413840115](#) [R414730000](#) [R415420000](#) [R415703000](#) [R416010000](#)
[R420003110](#) [R411801000](#) [R411815121](#) [R413305000](#) [R413801000](#) [R414520000](#) [R411808121](#) [R412500124](#) [R412414124](#) [R412501124](#)
[HMC-C584](#) [R413802000](#) [R412400124](#) [R411700124](#) [R417310130](#) [R411801119](#) [R412419124](#) [R411703124](#) [R412401124](#) [R443131000](#)
[R417130110](#) [R414700000](#) [R414505000](#) [R411802119](#) [R417720128](#) [R420706110](#) [R413811000](#) [R413803115](#) [R414501000](#) [R417903128](#)