

### DP3T-SPDT Coaxial Switches DC to 6 GHz, DC to 20 GHz, DC to 26.5 GHz, DC to 40 GHz

Radiall's PLATINUM SERIES switches are optimized to perform at a high level over an extended life span. With outstanding RF performances, and a guaranteed Insertion Loss repeatability of 0.03 dB over a life span of 10 million switching cycles. PLATINUM SERIES switches are perfect for automated test and measurement equipment, as well as signal monitoring devices.

#### PART NUMBER SELECTION

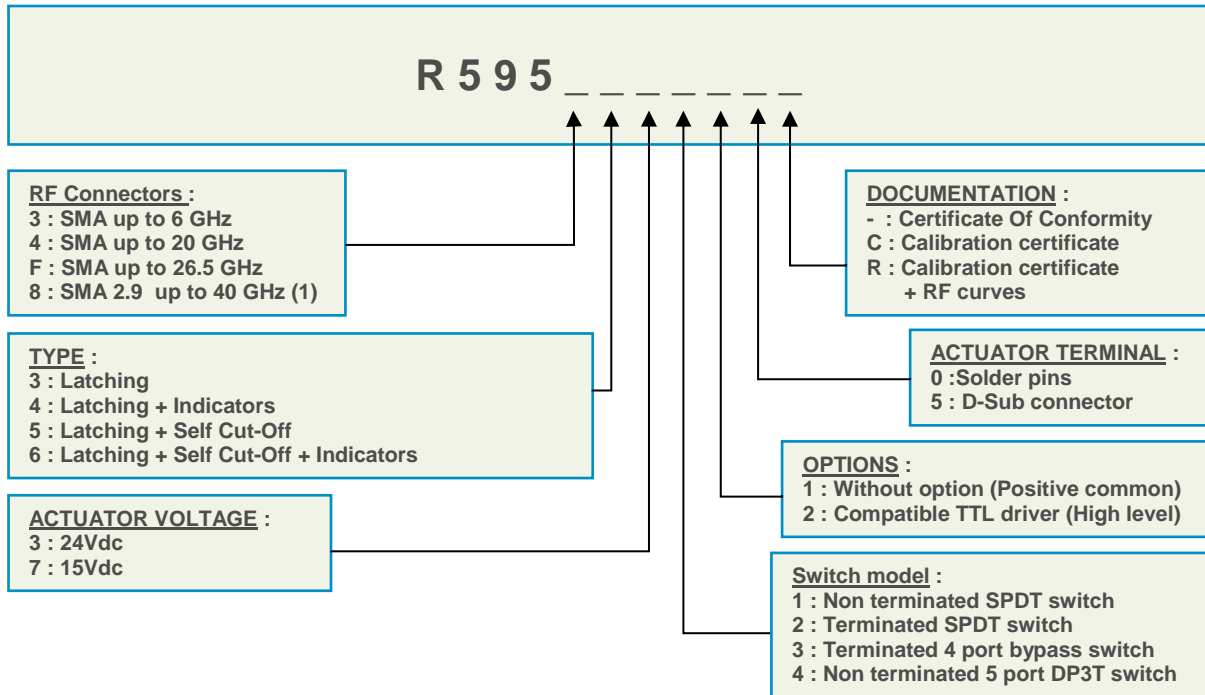

(1) Connector SMA2.9 is equivalent to "K Connector<sup>®</sup>", registered trademark of Anritsu

#### PICTURE



RF PERFORMANCES

PART NUMBER	R5953-----	R5954-----	R595F-----	R5958-----
Frequency Range GHz	DC to 6	DC to 20	DC to 26.5	DC to 40
Impedance Ohms	50			
Insertion Loss dB (Maximum)	0.20 + (0.45 / 26.5) x frequency (GHz)			
Isolation dB (Minimum)	85	DC to 6 GHz : 85 6 to 12.4 GHz : 75 12.4 to 20 GHz : 65	DC to 6 GHz : 85 6 to 12.4 GHz : 75 12.4 to 20 GHz : 65 20 to 26.5 GHz : 60	DC to 6 GHz : 85 6 to 12.4 GHz : 75 12.4 to 20 GHz : 65 20 to 26.5 GHz : 60 26.5 to 40 GHz : 55
V.S.W.R. (Maximum)	1.15	DC to 6 GHz : 1.15 6 to 12.4 GHz : 1.25 12.4 to 20 GHz : 1.30	DC to 6 GHz : 1.15 6 to 12.4 GHz : 1.25 12.4 to 20 GHz : 1.30 20 to 26.5 GHz : 1.60	DC to 6 GHz : 1.15 6 to 12.4 GHz : 1.25 12.4 to 20 GHz : 1.30 18 to 26.5 GHz : 1.60 26.5 to 40 GHz : 1.80
Third order Inter Modulation	-120 dBc typical (2 carriers 20W)			
Repeatability (up to 10 million cycles measured at 25°C)	0.03 dB maximum			0.05 dB maximum

TYPICAL RF PERFORMANCES

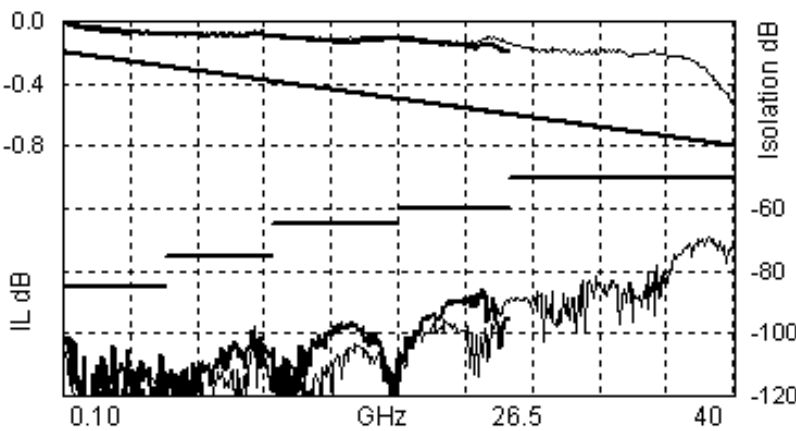

Insertion Loss and Isolation :

- 26.5GHz model with SMA connector
- - - 40GHz model with SMA2.9 connector

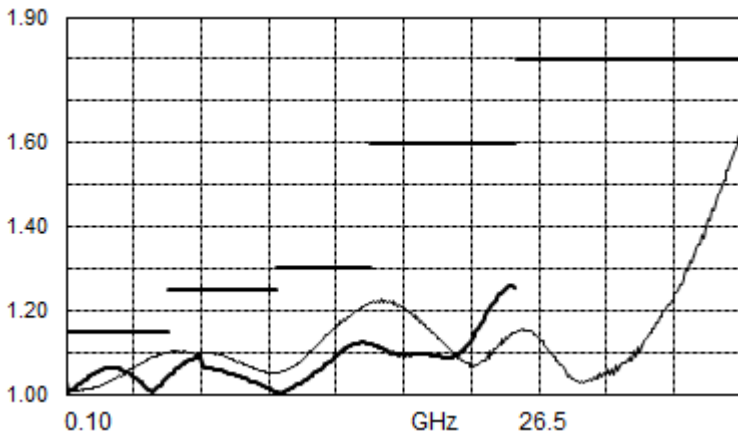

V.S.W.R. :

- 26.5GHz model with SMA connector
- - - 40GHz model with SMA2.9 connector

ADDITIONAL SPECIFICATIONS

Operating mode		Latching	
Nominal operating voltage (Vdc) (across operating temperature)			24 (20 / 32)      15 (12 / 20)
Coil resistance (+/-10%) (Ohms)		SPDT	350      120
		Terminated SPDT, DP3T, Bypass	175      60
Nominal operating current at 23°C (mA)		SPDT	68      125
		Terminated SPDT, DP3T, Bypass	140      250
Average power	All models	RF path	Cold switching : See Power Rating Chart on final page Hot switching : 1 Watt CW
	Terminated model	Internal terminations	1 Watt average into 50Ω
		External terminations	0.5 Watt average into 50Ω
TTL input	High Level	3 to 7 V	800 μA max at 7 V
	Low Level	0 to 0.8 V	20 μA max at 0.8V
Switching time max (ms)		15	
Life min for	SMA	10 million cycles	
	SMA 2.9	5 million cycles	
Connectors		SMA – SMA 2.9	
Actuator terminal		D-Sub pin female Solder pins	
Weight max (g)	SPDT	< 60	
	Terminated SPDT, DP3T, Bypass	< 100	

ENVIRONMENTAL SPECIFICATIONS

Operating temperature range (°C)	-25 to +75
Storage temperature range (°C)	-55 to +85
Temperature cycling (MIL-STD-202 , Method 107D , Cond.A) (°C)	-55 to +85 (10 cycles)
Sine vibration operating (MIL STD 202 , Method 204D , Cond.D)	10-2000 Hz, 20g
Random vibration operating	16.91g (rms) 50–2000 Hz 3min/axis
Shock operating (MIL STD 202 , Method 213B , Cond.G)	50g / 11 ms, sawtooth
Humidity operating	15 to 95% relative humidity
Humidity storage (MIL STD 202 , Method 106E , Cond.E)	65°C, 95% RH, 10 days
Altitude operating	15,000 feet (4,600 meters)
Altitude storage (MIL STD 202 , Method 105C , Cond.B)	50,000 feet (15,240 meters)

PAGE 4/12	ISSUE 05-11-18	SERIES DP3T/SPDT	PART NUMBER R595 XXX XXX
-----------	----------------	------------------	--------------------------

**SWITCH MODEL 1: NON TERMINATED SPDT SWITCH**

The non-terminated SPDT switch is a single pole double throw switch. This switch is “break before make”.

RF SCHEMATIC DIAGRAM



INDICATORS POSITION



**Standard drive option “1” (Positive common):**

- Connect pin +Vcc to supply
- Select desired RF path by applying ground to the corresponding "Close" pin (Ex: ground pin E1 to switch to position E1. RF path 1-2 closed and RF path 2-3 open).
- To open desired path and close the new RF path, connect ground to the corresponding “close” pin (Ex: ground pin E2 to open RF path 1-2 and close RF path 2-3)

**TTL drive option “2”**

- Connect pin GND to ground.
- Connect pin +Vcc to supply
- Select (close) desired RF path by applying TTL "High" to the corresponding "drive" pin (Ex: apply TTL "High" to pin E1 to switch to position E1. RF path 1-2 closed and RF path 2-3 open).
- To open desired path and close the new RF path, apply TTL "High" to the "drive" pin which corresponds to the desired RF path. (Ex: apply TTL "High" to pin E2 to open RF path 1-2 and close RF path 2-3).

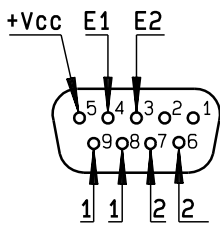

D-Sub connector

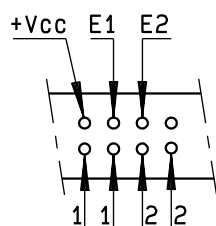

Solder pins

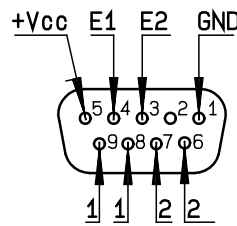

D-Sub connector

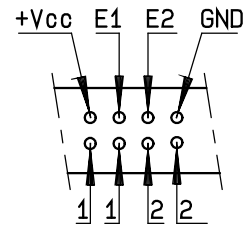

Solder pins

All dimensions are in millimeters [inches].

With D-Sub connector

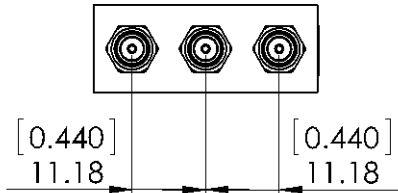

With solder pins

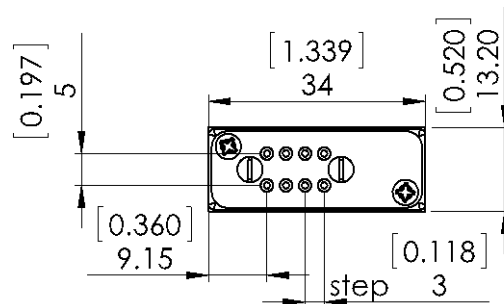
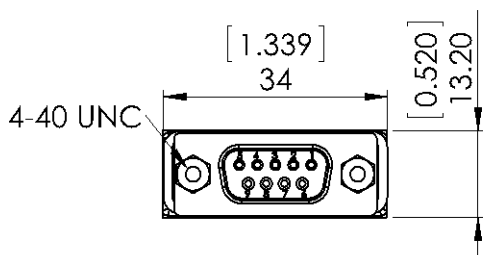
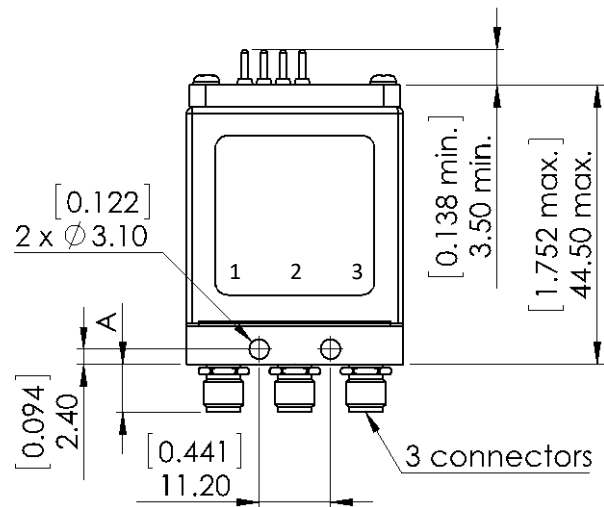
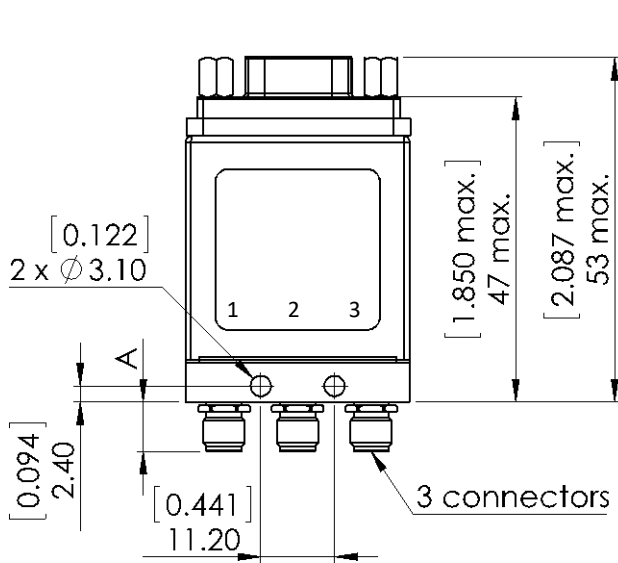
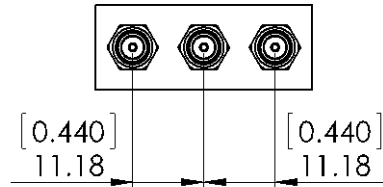

Connectors	A max mm [inches]
SMA up to 26.5GHz	7.7 [0.303]
SMA 2.9 up to 40GHz	6.7 [0.264]

PAGE 6/12	ISSUE 05-11-18	SERIES DP3T/SPDT	PART NUMBER R595 XXX XXX
-----------	----------------	------------------	--------------------------

**SWITCH MODEL 2: TERMINATED SPDT SWITCH**

The-terminated SPDT switch is a single pole double throw switch. The unused ports are terminated into 50ohms. This switch is “break before make”.

RF SCHEMATIC DIAGRAM

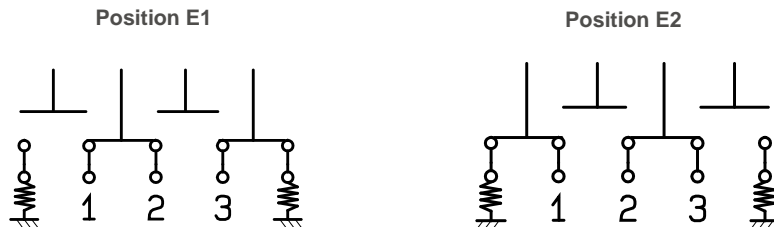

INDICATORS POSITION



**Standard drive option “1” (Positive common):**

- Connect pin +Vcc to supply
- Select desired RF path by applying ground to the corresponding "Close" pin (Ex: ground pin E1 to switch to position E1. RF path 1-2 closed and RF path 2-3 open).
- To open desired path and close the new RF path, connect ground to the corresponding “close” pin (Ex: ground pin E2 to open RF path 1-2 and close RF path 2-3)

**TTL drive option “2”**

- Connect pin GND to ground.
- Connect pin +Vcc to supply
- Select (close) desired RF path by applying TTL "High" to the corresponding "drive" pin (Ex: apply TTL "High" to pin E1 to switch to position E1. RF path 1-2 closed and RF path 2-3 open).
- To open desired path and close the new RF path, apply TTL "High" to the "drive" pin which corresponds to the desired RF path.  
(Ex: apply TTL "High" to pin E2 to open RF path 1-2 and close RF path 2-3).

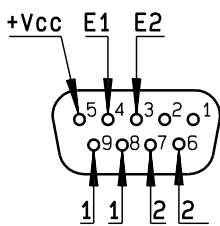

D-Sub connector

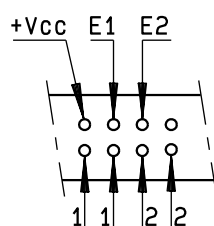

Solder pins

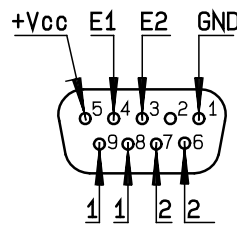

D-Sub connector

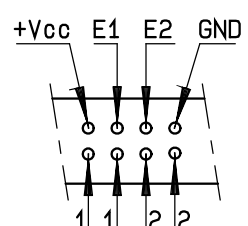

Solder pins

All dimensions are in millimeters [inches].

**Model SMA with D-Sub connector**

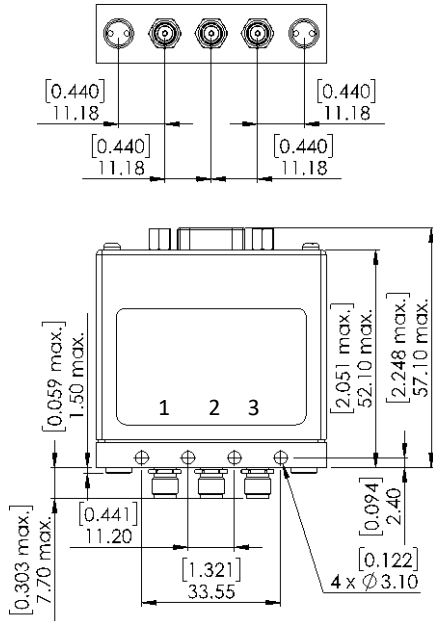

**Model SMA with solder pins**

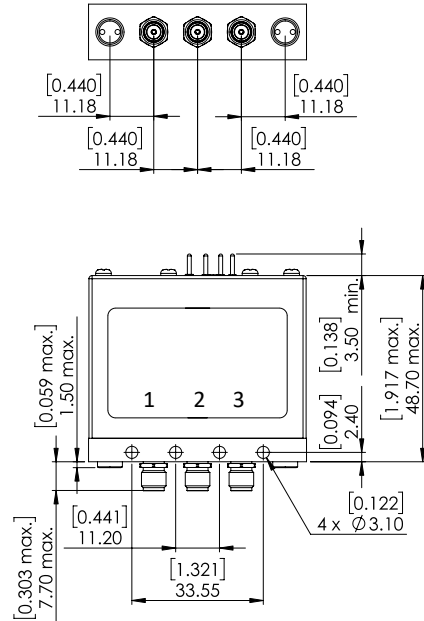

**Model SMA2.9 with D-Sub connector**

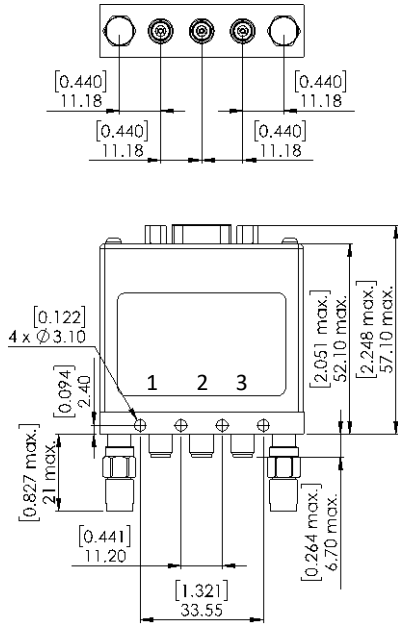

**Model SMA2.9 with solder pins**

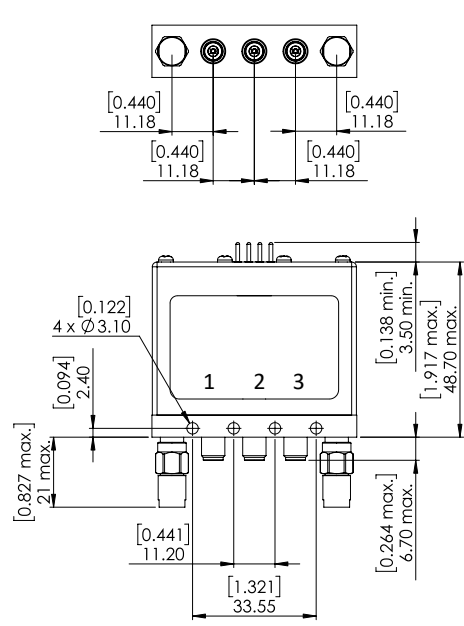

**TOP view - D-Sub connector**

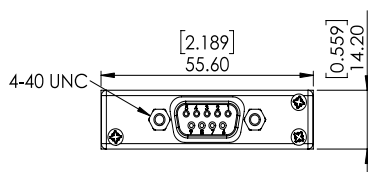

**TOP view - solder pins**

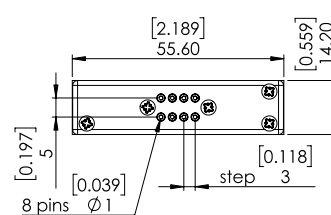

PAGE 8/12	ISSUE 05-11-18	SERIES DP3T/SPDT	PART NUMBER R595 XXX XXX
-----------	----------------	------------------	--------------------------

**SWITCH MODEL 3: TERMINATED 4 PORT BYPASS SWITCH**

The terminated 4 port bypass switch can terminate into 50 ohms the device under test. These switches are “break before make”.

RF SCHEMATIC DIAGRAM

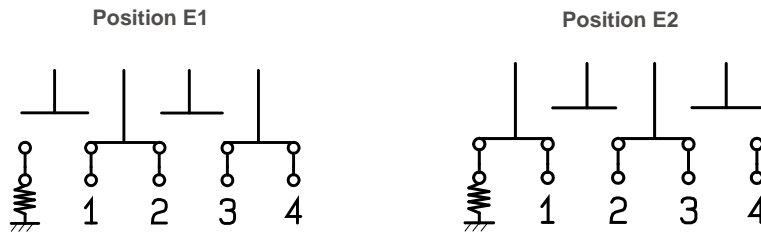

INDICATORS POSITION



**Standard drive option “1” (Positive common):**

- Connect pin +Vcc to supply
- Select desired RF path by applying ground to the corresponding "Close" pin (Ex: ground pin E1 to switch to position E1. RF path 1-2 closed and RF path 2-3 open).
- To open desired path and close the new RF path, connect ground to the corresponding "close" pin (Ex: ground pin E2 to open RF path 1-2 and close RF path 2-3)

**TTL drive option “2”**

- Connect pin GND to ground.
- Connect pin +Vcc to supply
- Select (close) desired RF path by applying TTL "High" to the corresponding "drive" pin (Ex: apply TTL "High" to pin E1 to switch to position E1. RF path 1-2 closed and RF path 2-3 open).
- To open desired path and close the new RF path, apply TTL "High" to the "drive" pin which corresponds to the desired RF path.  
(Ex: apply TTL "High" to pin E2 to open RF path 1-2 and close RF path 2-3).

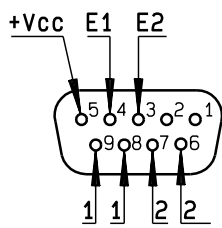

D-Sub connector

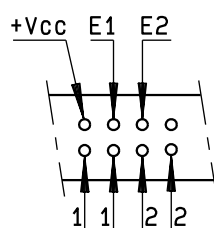

Solder pins

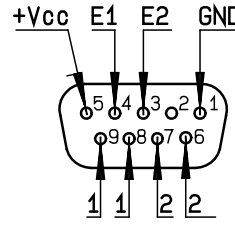

D-Sub connector

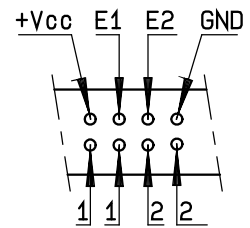

Solder pins



All dimensions are in millimeters [inches].

**Model 26.5 GHz with D-Sub connector**

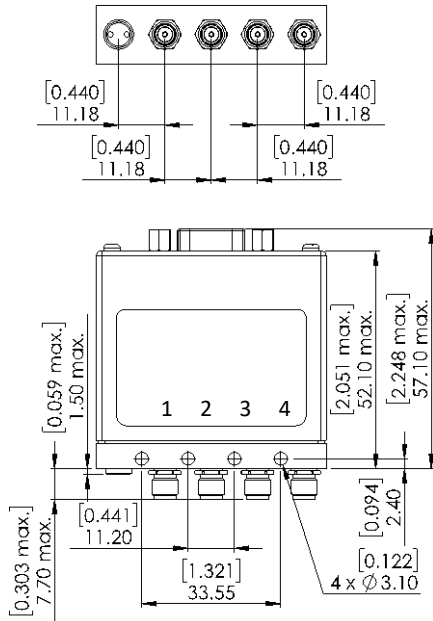

**Model 26.5 GHz with solder pins**

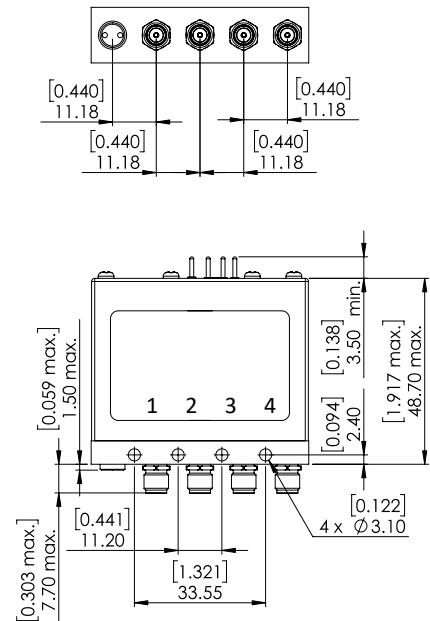

**Model 40 GHz with D-Sub connector**

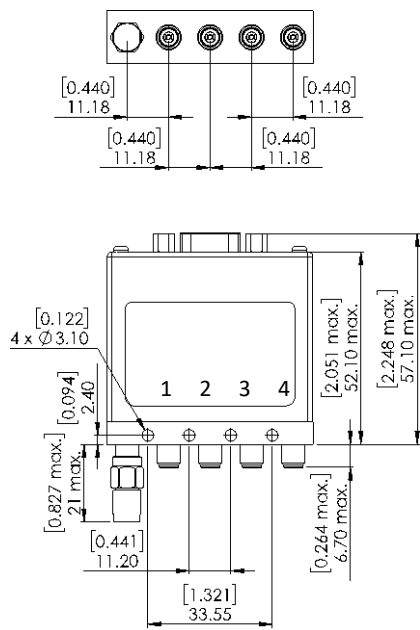

**Model 40 GHz with solder pins**

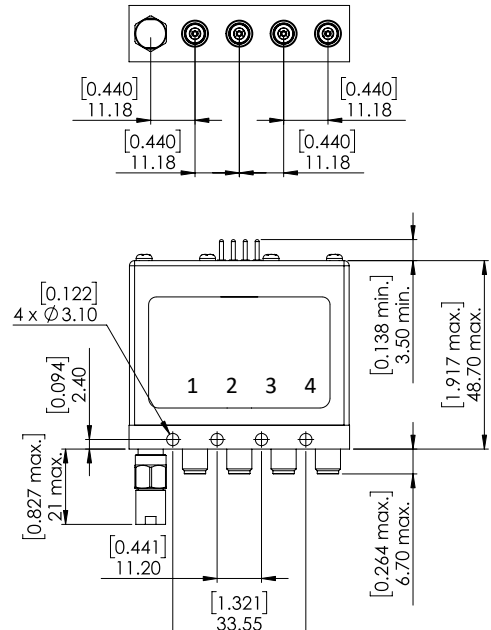

**TOP view - D-Sub connector**

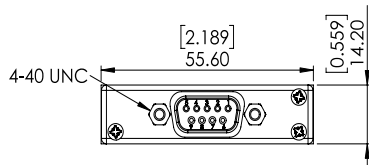

**TOP view - solder pins**

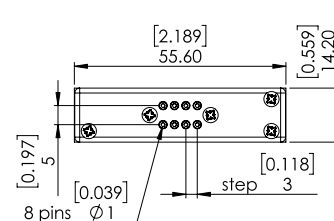

PAGE 10/12	ISSUE 05-11-18	SERIES DP3T/SPDT	PART NUMBER R595 XXX XXX
------------	----------------	------------------	--------------------------

## SWITCH MODEL 4: NON TERMINATED 5 PORT DP3T SWITCH

The non-terminated 5 port DP3T switch can be used as SPDT with high power terminations, as a bypass switch. In this application, the fifth port can be terminated externally with a high power termination. These switches are "break before make".

### RF SCHEMATIC DIAGRAM

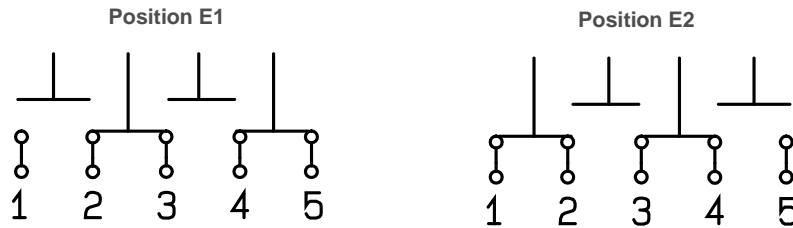

### INDICATORS POSITION



#### Standard drive option "1" (Positive common):

- Connect pin +Vcc to supply
- Select desired RF path by applying ground to the corresponding "Close" pin (Ex: ground pin E1 to switch to position E1. RF path 2-3 and RF path 4-5 open).
- To open desired path and close the new RF path, connect ground to the corresponding "close" pin (Ex: ground pin E2 to open RF path 2-3 and 4-5 and close RF path 1-2 and 3-4)

#### TTL drive option "2"

- Connect pin GND to ground.
- Connect pin +Vcc to supply
- Select (close) desired RF path by applying TTL "High" to the corresponding "drive" pin (Ex: apply TTL "High" to pin E1 to switch to position E1. RF path 2-3 and RF path 4-5 closed and RF path 1-2 and 3-4 open).
- To open desired path and close the new RF path, apply TTL "High" to the "drive" pin which corresponds to the desired RF path. (Ex: apply TTL "High" to pin E2 to open RF path 2-3 and 4-5 and close RF path 1-2 and 3-4).

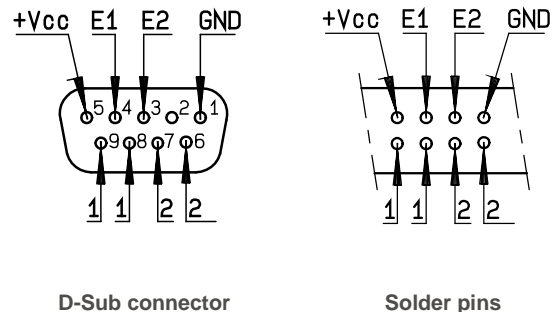
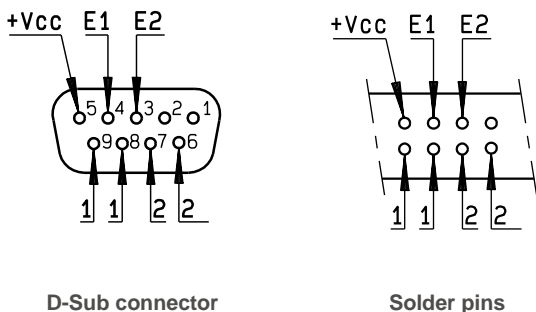

PAGE 11/12	ISSUE 05-11-18	SERIES DP3T/SPDT	PART NUMBER R595 XXX XXX
------------	----------------	------------------	--------------------------

All dimensions are in millimeters [inches].

With D-Sub connector

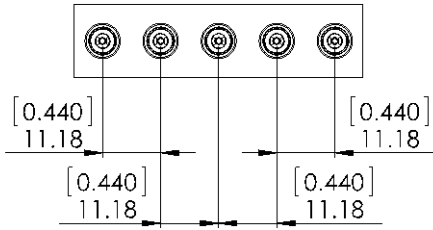

With solder pins

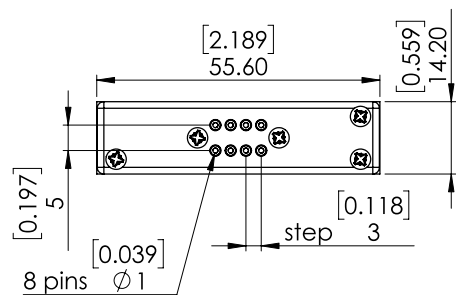
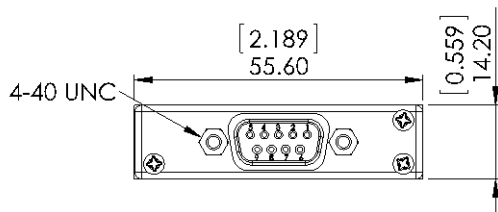
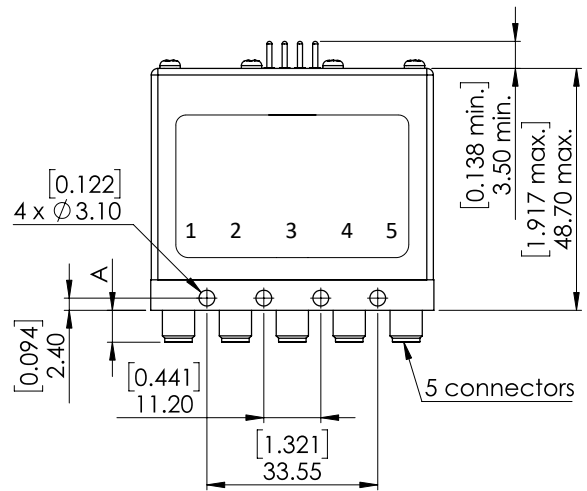
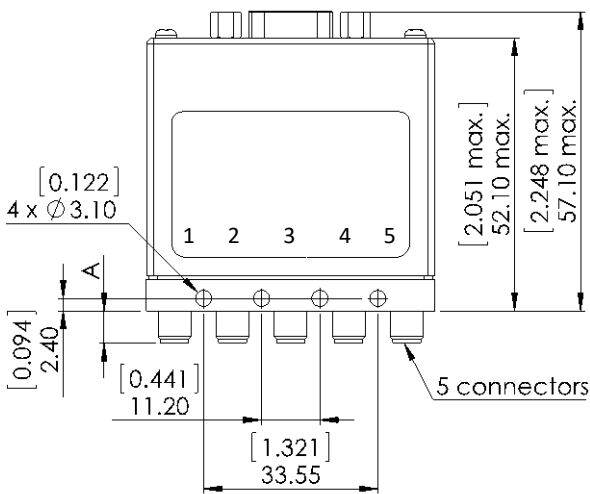
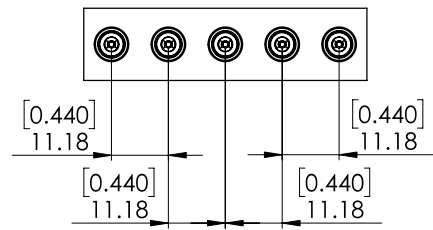

Connectors	A max mm [inches]
SMA up to 26.5GHz	7.7 [0.303]
SMA 2.9 up to 40GHz	6.7 [0.264]

PAGE 12/12	ISSUE 05-11-18	SERIES DP3T/SPDT	PART NUMBER R595 XXX XXX
------------	----------------	------------------	--------------------------

POWER RATING CHART

This graph is based on the following conditions:

- Ambient temperature: + 25°C
- Sea level
- V.S.W.R.: 1 and cold switching

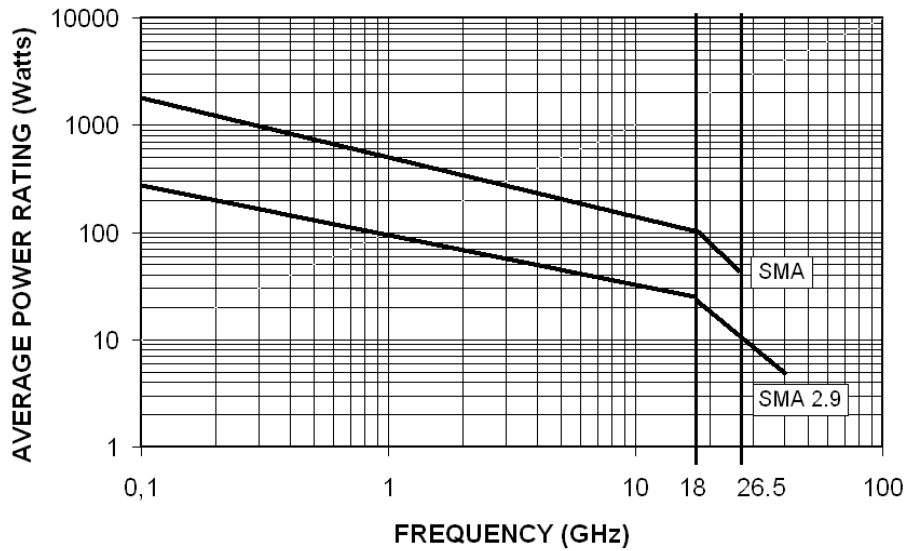

DERATING FACTOR VERSUS V.S.W.R.

The average power input must be reduced for load V.S.W.R. above 1.

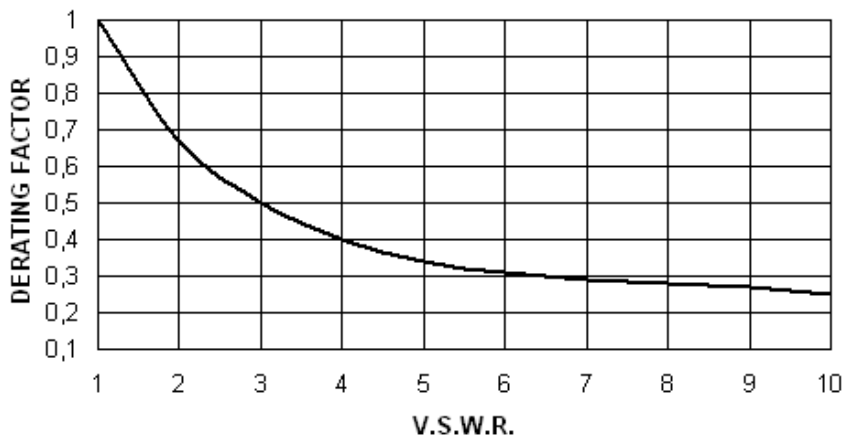

## X-ON Electronics

Largest Supplier of Electrical and Electronic Components

*Click to view similar products for [Coaxial Switches](#) category:*

*Click to view products by [Radiall](#) manufacturer:*

Other Similar products are found below :

[CR-53S10](#) [R599311000](#) [R599906000](#) [R599910000](#) [CCT-38S150-T](#) [CR-58S160](#) [MS180LH3-HRMJ-040V300A](#) [R599312000](#) [R512F73417](#)  
[R514F73417](#) [R595333210](#) [R595F53225](#) [R591363400](#) [R595433410](#) [R595333215](#) [R595337220](#) [R595343115](#) [R595343125](#) [R591362440](#)  
[R593373148](#) [R595343215](#) [CCR-33K40](#) [R595357325](#) [CCS-18N480-TDS](#) [R591702640](#) [R591763600](#) [CR-33K10](#) [R599313000](#) [R516431100](#)  
[R591722605](#) [ARD15105](#) [MS156LH1-HRMJ-088V300A](#) [R570412000](#) [R570412100](#) [R570413000](#) [R570422100](#) [R570423000](#) [R570432000](#)  
[R570433000](#) [R570442000](#) [R570442100](#) [R570412030](#) [R570423030](#) [R570432010](#) [R570433100](#) [R570443030](#) [R570463100](#) [R570442010](#)  
[R570413030](#) [R570452000](#)