

TEST AND MEASUREMENT

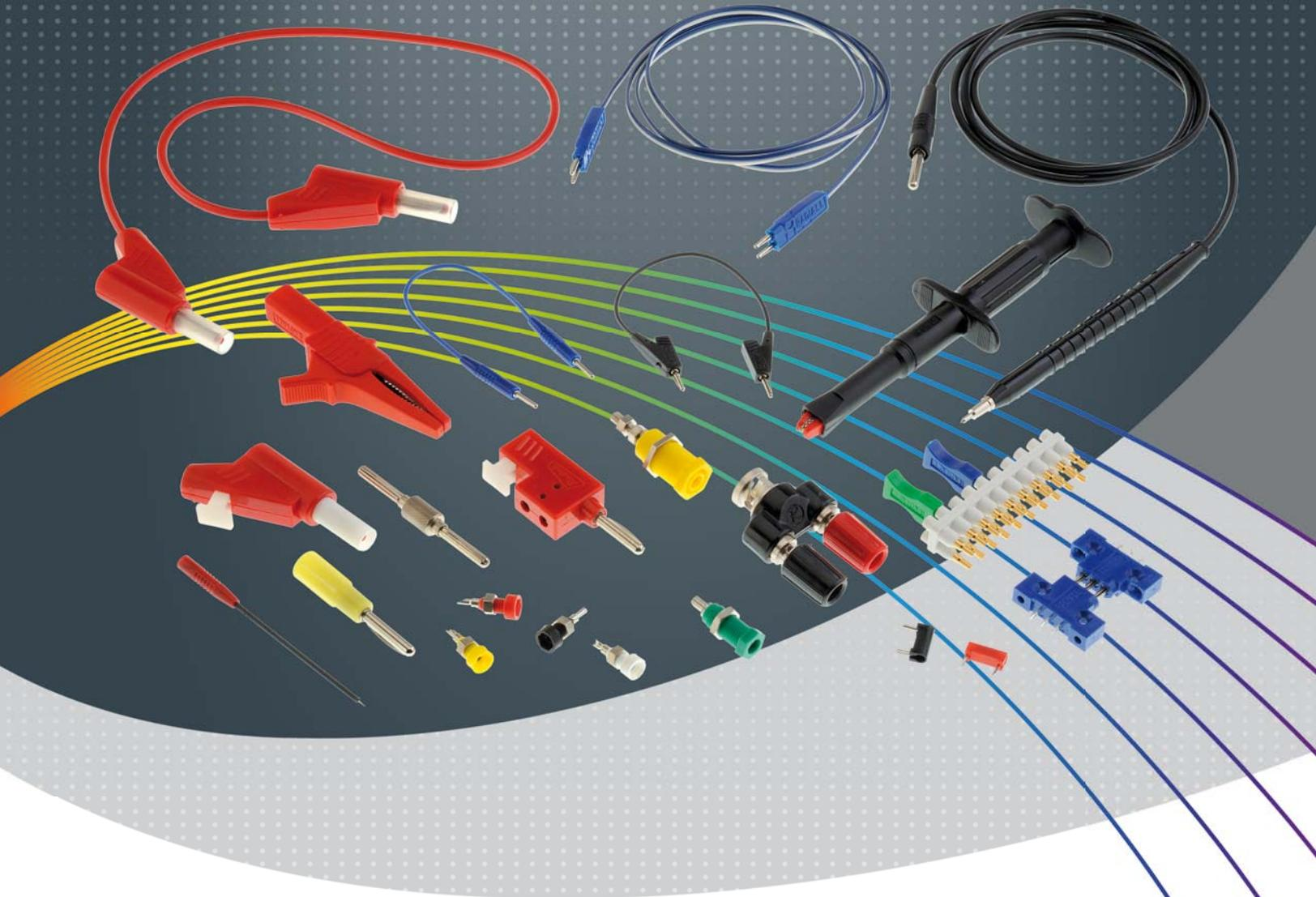

## Banana Plugs Series

**RADIALL**   
The next connexion

# COMPANY PROFILE



Technical information and sales contacts are available at : [www.radiall.com](http://www.radiall.com)

## Simply Your Best Connection

Radiall is a global leader in the design, development and manufacturing of leading edge interconnect solutions. Dedicated to understanding its customers' needs since 1952, Radiall has earned the reputation of being "the best of the best" in engineering ingenuity by providing a constant flow of creative system solutions serving the telecommunications, aerospace, defense, instrumentation, automotive, industrial, medical and broadcast markets.

## The Best End-to-End Interconnect Solutions

We offer an extensive range of solutions that supports the most demanding signal transmission applications. 4G wireless infrastructure, active array radars, IED's detection, electrical wiring in aircrafts, soldier tactical radios, in-vehicle communications networks, and magnetic resonance imaging systems are just a few of the complex applications that we support.

- RF coaxial connectors
- Fiber optic connectors and transceivers
- Coaxial and fiber optic cable assemblies and harnesses
- High frequency microwave components
- Coaxial switches, including the smallest and most reliable SPDT relay
- Multipin rectangular connectors
- Rack and panel connectors
- Antennas for tactical networks, aerospace and instrumentation

## Best Value-added Services

- **Collaboration:** We work closely with your engineers to understand your business, your technical needs, and your budgetary issues;
- **Wide Product Range:** We manage our product lines thru the entire lifecycle in order to offer you a wide selection of standard products at an affordable cost;
- **Custom Products:** We can tailor products to specific equipment and application needs;
- **Global Presence:** We're everywhere you need us, with worldwide sales, engineering support, R&D in North America, Europe, and Asia, and manufacturing facilities strategically located in the United States, Mexico, France, India, and China;
- **Responsive Support and Service:** From the design stage, planning to post-installation support, we're with you at every step, whether you need sales support or engineering expertise;
- **On-time Delivery:** We support your logistical needs so you get the products when and where you need them;
- **Warranty:** We proudly stand behind our products.



## Certifications and Environmental

Radiall is ISO 9001: 2008 certified and dedicated to continuous improvement programs that have resulted in also being AS9100, TS16949 and ISO 14001 certified. In addition, Radiall is committed to investing in its people, future technologies and the environment, such as being RoHS (Restriction of Hazardous Substances) and REACH (Registration, Evaluation, Authorization and Restriction of Chemical substances) compliant.

	<b>Pages</b>
Introduction .....	4 to 6
Finder guide .....	7 to 8

**4 mm SERIES**

Introduction .....	9
Characteristics .....	10
Packaging .....	10
Safety series plugs .....	11
sockets .....	11
patch cords .....	12 to 13
Standard series plugs .....	14
sockets .....	15
patch cords .....	15 to 17
Accessories .....	18

**2 mm SERIES**

Introduction .....	19 to 20
Characteristics .....	21 to 22
Packaging .....	22
Plugs .....	23
Sockets .....	24
Patch cords .....	24 to 25
20 way fixed connectors .....	26
Contact blocks .....	27
Ribbon patch cords .....	28
Polarized contact blocks .....	28
Polarized ribbon patch cords .....	29
Accessories .....	30

**BANANA ADAPTERS**

Introduction .....	31
Characteristics .....	31
Packaging .....	31
Adapters .....	32
Adapters patch cords .....	33

Panel drilling .....	34
Index .....	35

# INTRODUCTION

Radiall offers a wide selection of high quality and reliable professional banana plugs for the most demanding test and measurement applications.

Radiall professional banana plugs consist of two major series and adapters:

- **The 4 mm Series**

- Safety plugs and sockets
- Safety patch cords
- Standard plugs and sockets
- Standard patch cords
- Accessories

- **The 2 mm Series**

- Plugs and sockets
- Patch cords
- PCB test points
- 20-way fixed connector
- Short circuit links
- Contact block and ribbon patch cords
- Accessories

- **Adapters**

- 2 mm/4 mm banana adapter
- BNC/2 mm banana adapter
- BNC/4 mm banana adapter
- Banana adapter patchcord
- Coaxial banana adapter patchcord

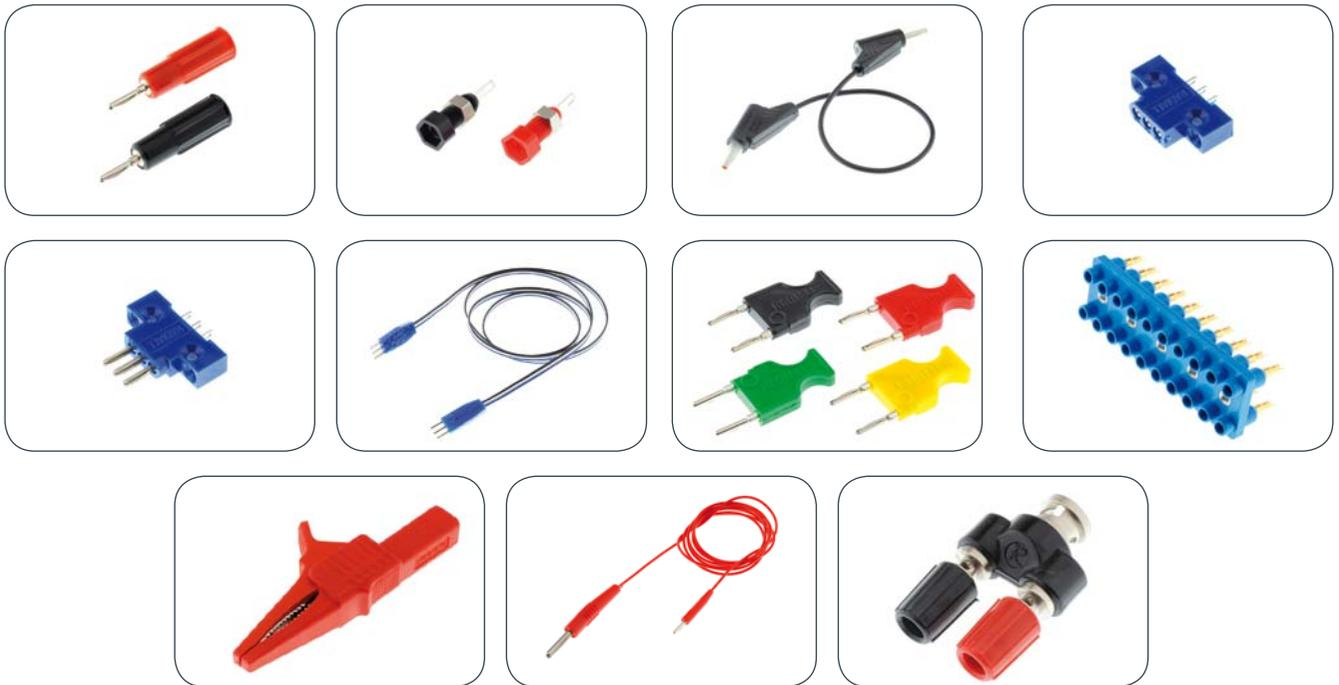

## APPLICATIONS

- Research institutes and laboratories
- Education
- Instrumentations
- Low voltage
- Electronics



The Bananas Plugs have been designed in accordance with the NF C 93 440.

[www.radiall.com](http://www.radiall.com)

## FEATURES AND BENEFITS

### Features

Radiall in-house technologies insure high reliable products thanks to its advanced proper design.

#### Radiall contact design

The Radiall contact consists of a monobloc pin fitted with a copper beryllium spring finger. Depending on the model, the pin either has or has not a protective sleeve.

	4 mm SERIES	2 mm SERIES
Contact resistance, max.	0.5 mΩ	1 mΩ
Current rating, max @ 20°C	30 A	10 A
Contact durability, min.	10,000 mating cycles	

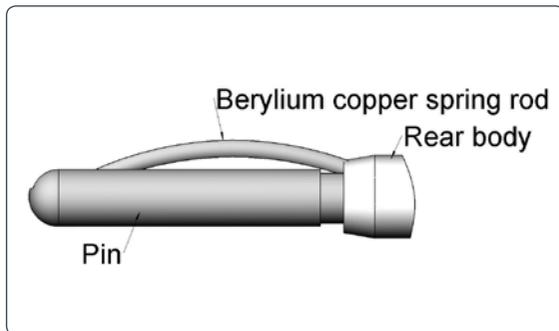

### Benefits

- Excellent electrical conduction
- Very low contact resistance
- Robust contact point pressure when connected
- High durability for high number of mating cycles

## GLOSSARY OF ABBREVIATIONS

ABBREVIATION SERIES		DESIGNATION
4mm	2mm	
B1	BL-I	Insulated plug with solder connection
B2		Insulated plug with crimp or solder connection
	BL-PI	Insulated panel plug
B4	BL	Uninsulated plug
	BL2-4	Uninsulated threaded plug
	BLP-4	Uninsulated panel plug with solder connection
DPI	DL-PI	Insulated panel socket
DPIS		Insulated safety panel socket
DP	DLP	Uninsulated panel socket
	BLP D-2	Uninsulated panel plug/2mm dia. socket
BDR-4	BDR-2	Stackable plug with quick grip cable clamp
BDR-SR		Stackable plug, partial safety
BDR-PR		Stackable plug, partial safety non thermofusible sleeve
BDM	BDM	Stackable patch cord
BDSA		Stackable patch cord, total safety
BDSR		Stackable patch cord, partial safety
BM	BLM	Extension patch cord
DM	DLM	Extension female patch cord
PTM		Test probe patch cord
	FL	Contact block
	ML	Ribbon patch cords

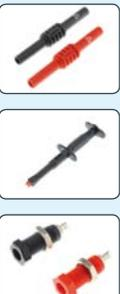
SERIES	IMAGE	CATEGORY	DESCRIPTION	PAGE		
4 mm		Safety series	Banana plugs	Stackable plug (BDR-SR)	11	
				Stackable plug, non thermofusible sleeve (BDR-PR)		
			Panel sockets	Insulated safety panel socket (DPIS)		
		Safety series	Patch cords	Plug/Plug stackable, retractable sleeve (BDSR)	12	
				Plug/Plug stackable, non-retractable sleeve (BDSA)		
				Patch cords made to order	13	
		Standard series	Banana plugs	Uninsulated plug (B4)	14	
				Insulated plug with solder connection (B1)		
				Insulated plug with crimp or solder connection (B2)		
				Stackable plug with quick grip cable clamp (BDR-4)		
			Standard series	Panel sockets	Uninsulated panel sockets (DP)	15
					Insulated panel sockets (DPI)	
			Standard series	Patch cords	BM/BM extension patch cords	16
					BDM/BDM stackable patch cords	
					PTM/BM Test probe patch cords	
					Patch cords made to order	17
		Accessoires & adapter		Test clip- with sliding hook	18	
			Test clip - with alligator clip			
			Test clip - with flexible steel rod			
			Crocodile clip			
			Safety test probe			
			Safety female -female adapter			
2 mm		Standard series	Banana plugs	Uninsulated plug with crimp or solder connection (BL)	23	
				Uninsulated panel plug with solder connection (BLP-4)		
				Uninsulated panel plug/2mm dia.socket (BLP D-2)		
				Insulated plugs with solder connection (BL-I)		
				Insulated panel plug (BL-PI)		
				Stackable plug with quick grip cable clamp (BDR-2)		
		Standard series	Panel sockets	Uninsulated panel sockets (DLP)	24	
				Insulated panel socket (DL-PI)		
		Standard series	Patch cords	BLM extension patch cords	25	
				BLDM stackable patch cords		
Patch cords made to order						

To download data sheets, visit [www.radiall.com](http://www.radiall.com)  
 For other specific demand, please contact Radiall sales

FINDER GUIDE

SERIES	IMAGE	CATEGORY		DESCRIPTION	PAGE
2 mm		Standard series	Multi-contact 20-way fixed connectors	Solder cup - 12 mm contact pitch	26
				Solder cup - 6 mm contact pitch	
				Pin - 12 mm contact pitch	
				Pin - 6 mm contact pitch	
		Contact Blocks & Ribbon patch cords and polarization	Short cut circuit	12 mm contact pitch	27
				6 mm contact pitch	
		Contact Blocks & Ribbon patch cords and polarization	Contact blocks	Male contact blocks (FL M)	28
				Female contact blocks (FL F)	
			Patch leads	Male-male ribbon patch cords (ML MM)	29
				Female-female ribbon patch cords (ML FF)	
	Polarized contact blocks Polarized ribbon patch cords	Polarized contact blocks	29		
		Polarized ribbon patch cords (made to order)			
		Accessoires		PCB Test socket	30
				Test probe	
Adapters		Banana adapters	Banana adapters	2 mm Male - 4 mm Female	32
			BNC/Banana adapters	BNC/2 mm Banana adaptor	
		BNC/4 mm Banana adaptor			
		Banana adapters patch cords		BLM/BM	33
				BLDM/BDM	
				BLM/DM	
		Coaxial patch cords		BNC/BCX	

## 4 mm SAFETY SERIES

With safety an important criteria when using test and measurement instrumentation, especially for high-voltage use, the Radiall 4 mm Safety Series offers an improved protection system that eliminates all risk of contact with live elements when handling components.

Safety connectors are reinforced by a protective sleeve and an insulation cap on the top of the contact.

The protective sleeve may be retractable or non-retractable. All plugs with non-retractable sleeves are rated at 600V, CAT III or 1000V, CAT II according to the safety standard IEC 61010-031 version 2002.

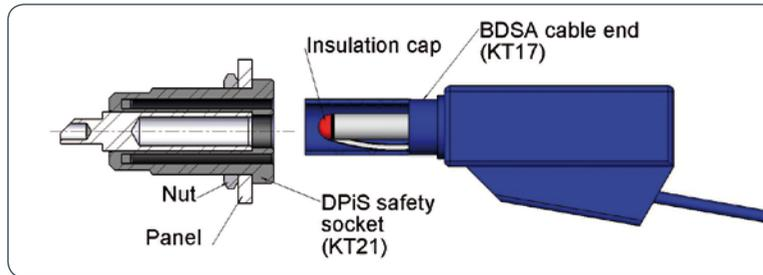

## 4 mm STANDARD SERIES

The 4 mm Standard Series meets the requirements of NF C 93 440 standards.

The product in this series are not intended for hand-held use at voltage above 30Vac/60Vdc.

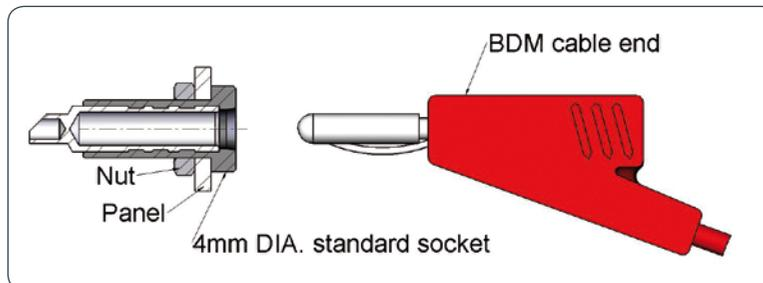

Example of a regular connection: the contact is exposed.

## ACCESSORIES: TEST CLIPS

**With sliding hook:** The contact hook guarantees a good grip on wires, components and PCB pin up to 1.5mm<sup>2</sup> thick.

**Alligator Test Clips:** Features a large opening and gripping efficiency for use on motors, fuse holders, terminals, etc.

**Flexible Steel Rod Test Clips:** The thin flexible steel rod allows testing of hard-to-reach points in dense circuitry.

**Crocodile Test Clips:** Features a large 20 mm opening to allow attachment to larger test points.

**Safety Test probe:** An extra thin probe allows contact through coatings and some insulations. It can also be used for PCB measurements. Fitted with a rear-mounted 4 mm socket, it can be used with BM patch cords.

## CHARACTERISTICS

	PLUGS	SOCKETS	PATCH CORDS
<b>ELECTRICAL</b>			
Current rating, max. 4 mm safety 4 mm standard	30 A (at 20°C)		15 A (at 20°C) patch cords 1 mm <sup>2</sup> 15 A (at 20°C) patch cords 1 mm <sup>2</sup> 30 A (at 20°C) 2 and 2.5 mm <sup>2</sup>
Dielectric withstanding voltage	2500 V <sub>rms</sub> at 50 Hz		
Operating voltage	750 V <sub>rms</sub> at 50Hz		
Insulation resistance, min	5000 MΩ		
Contact resistance, max	0.5 mΩ		
<b>MECHANICAL</b>			
Mechanical, durability, min.	10 000 matings		
Average insertion force	25 N		
Tightening torque 4 mm safety 4 mm standard		Max 140 N.cm 120Ncm	
<b>ENVIRONMENTAL</b>			
Temperature range 4 mm Safety	-40°C/+85°C	-40°C/+100°C	BDSR patch cords -40°C/+85°C BDSA patch cords -25°C/+70°C
4 mm standard	(uninsulated) (insulated models)	-65°C/+155°C -60°C/+100°C	-40°C/+70°C
<b>MATERIAL</b>			
Insulation	Thermoplastic		
Contacts	Nickel or tin plated Copper alloy/brass		

## CHARACTERISTICS ACCESSORIES

	WITH SLIDING HOOK	WITH ALLIGATOR CLIP	WITH FLEXIBLE STEEL RODS	WITH CROCODILE DIE	SAFETY TEST PROBE
<b>ELECTRICAL CHARACTERISTICS</b>					
Operating voltage, max.	1000 V <sub>rms</sub>				1500 V <sub>rms</sub>
Current rating max	4 A (at 20°C)	16 A (at 20°C)	2.5 A	32 A	
Clip opening (max)	1.5mm (max hooking capacity)	20 mm	-	20 mm	-
<b>MATERIALS</b>					
Body	Thermoplastic				
Contact	Stainless steel				Steel

## PACKAGING

	4 mm SAFETY SERIES	4 mm STANDARD SERIES
Plugs	10 pieces	100 pieces (except BDR4 = 10pieces)
Panel sockets	100 pieces	
Patch cords	10 pieces	
Accessories	10 pieces	

**STACKABLE PLUG, PARTIAL SAFETY (BDR-SR)**

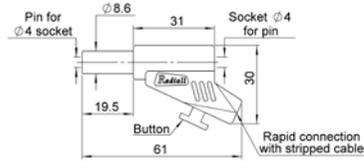
FIGURE	PART NUMBER	COLOR	STANDARD
 	R941 460 600	Black	NFC 93440-KT12R
	R941 461 600	Red	
	R941 462 600	Green	
	R941 463 600	Blue	
	R941 464 600	Yellow	

**STACKABLE PLUG, PARTIAL SAFETY - NON-THERMOFUSIBLE SLEEVE (BDR-PR)**

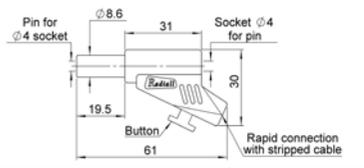
FIGURE	PART NUMBER	COLOR	STANDARD
 	R941 480 600	Black	NFC 93440 - KT12R DCN 5935 BA
	R941 481 600	Red	

**SOCKETS**

**INSULATED SAFETY PANEL-MOUNT SOCKETS (DPIS)**

Insulated safety panel sockets are mateable with standard 4 mm BM/BDM patch cords and BDRS/BDSA safety patch cords.

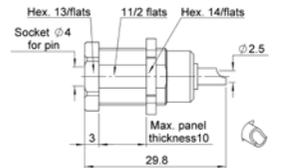
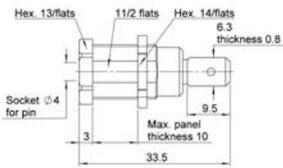
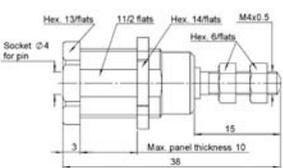
FIGURE	PART NUMBER	COLOR	TERMINATION	STANDARD	PANEL DRILLING
 	R941 920 600	Black	Solder cup	NFC 93440-KT21F	P05
	R941 921 600	Red			
	R941 922 600	Green			
	R941 923 600	Blue			
	R941 924 600	Yellow			
 	R941 920 602	Black	Flat for FASTON lug type	NFC 93440-KT21L	P05
	R941 921 602	Red			
 	R941 920 603	Black	For fork lug	NFC 93440-KT21V	P05
	R941 921 603	Red			
	R941 924 603	Yellow			

To download data sheets, visit [www.radiall.com](http://www.radiall.com)  
For other specific demand, please contact Radiall sales

# PATCH CORDS

Except where specified, all patch cords lengths are defined by the length of the cable without connectors or strain relief.

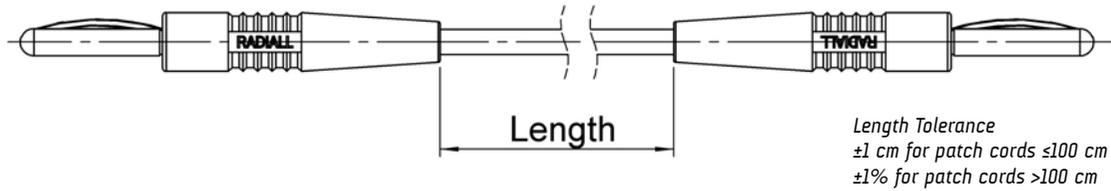

Radiall Patch Cord Series includes:

- **BDSR/BDSR**: Retractable sleeve for partial security
- **BDSA/BDSA**: Non-retractable sleeve where secure connections are critical;  
The cable assembly is rated at 1000V, CAT II according to the safety standard IEC61010-31
- Patch cords made-to-order

## PLUG/PLUG STACKABLE PATCH CORDS - RETRACTABLE SLEEVE (BDSR/BDSR)

Cable type: PVC, 1 mm<sup>2</sup> conductor, 3.5 mm.



### R948 1xx 600

Patch cords length:

- 3 : 25 cm
- 4 : 50 cm
- 5 : 100 cm
- 6 : 150 cm
- 7 : 200 cm

Colour:

- 0 : Black
- 1 : Red

## PLUG/PLUG STACKABLE PATCH CORDS - NON-RETRACTABLE SLEEVE (BDSA/BDSA)

Cable type: PVC, 1 mm<sup>2</sup> conductor, 3.5 mm.



### R948 3xx 600

Patch cords length:

- 0 : 25 cm
- 1 : 50 cm
- 2 : 100 cm

Colour:

- 0 : Black
- 1 : Red

**MADE-TO-ORDER PATCH CORDS**

Customized patch cords using BDSR plugs can be made-to-order to your specifications. Choices include connector style, cable type, color, and cable length.

**HOW TO ORDER**

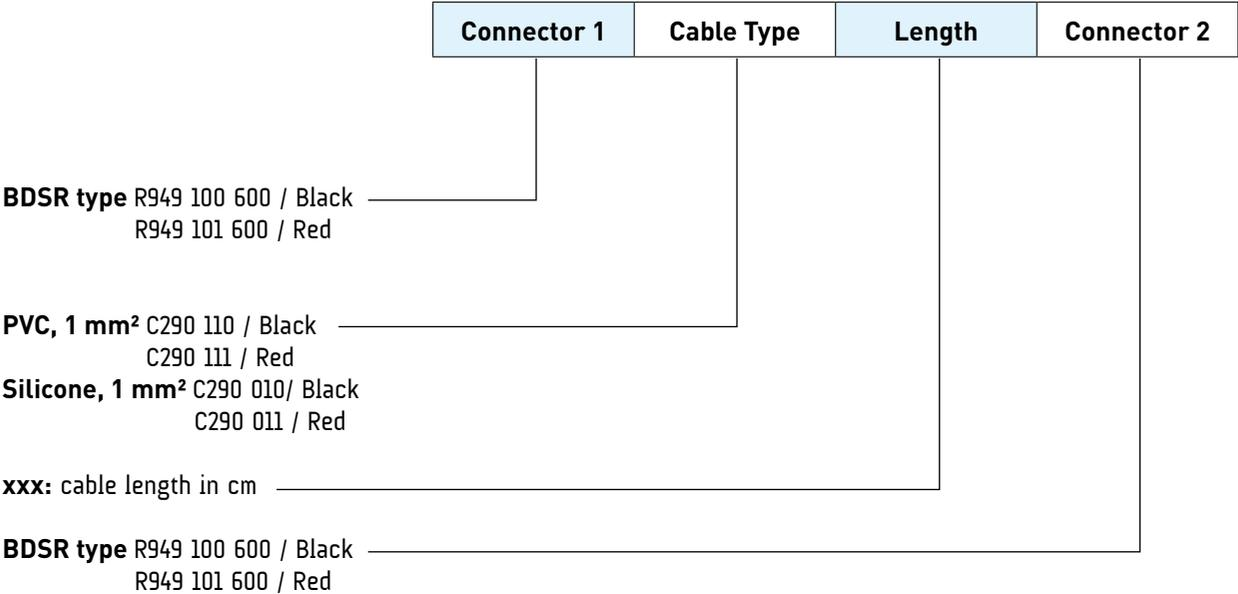

**EXAMPLE TO ORDER:**

1 Black BDSR plug / red silicone 1mm<sup>2</sup> cable length 125 cm / 1 Red BDSR plug.  
Part number: **R949 100 600 / C290 011-125 cm / R949 100 600**

For other specific demand, please contact Radiall sales

# PLUGS

## UNINSULATED BANANA PLUGS

FIGURE	PART NUMBER	DESCRIPTION	PANEL DRILLING
	R941 019 000	<b>Solder or crimp</b> <b>1.5 mm solder post</b> Strip length: 5 mm Crimp tool: Buchanan R612 548 000 Positioner Radiall R282 561 000 Crimp setting: 1.20 (18 AWG) 1.08 (22 AWG) Maxi 15A	
	R941 029 000	<b>Solder or crimp</b> <b>2 mm solder post</b> Strip length: 5 mm Crimp tool: Buchanan R612 548 000 Positioner Radiall R282 561 000 Crimp setting: 1.50 (14 AWG) 1.25 (18 AWG)	
	R941 049 000	<b>Threaded panel connection</b> 8 mm rear length	P03
	R941 069 000	<b>Threaded panel connection</b> 18 mm rear length	P03
	R941 149 000	<b>Panel banana plug</b> 4 mm with rear socket for mating with 4 mm plug	P01

## INSULATED BANANA PLUGS

FIGURE	PART NUMBER	COLOR	REAR TERMINATION OPTIONS
	R941 330 000	Black	- Tin-plated solder cup or - Rear socket for 2 mm banana plug (14 AWG)
	R941 331 000	Red	
	R941 332 000	Green	
	R941 333 000	Blue	
	R941 334 000	Yellow	
	R941 336 000	White	
	R941 340 000	Black	- Tin-plated solder cup or - Screw tightening or - Rear socket for 2 mm banana plug (14 AWG)
	R941 341 000	Red	
	R941 342 000	Green	
	R941 343 000	Blue	
R941 344 000	Yellow		
	R941 460 000	Black	- Stackable banana with quick-grip clamp for stripped cable - 2 & 4 mm socket for banana plugs
	R941 461 000	Red	

To download data sheets, visit [www.radiall.com](http://www.radiall.com)  
 For other specific demand, please contact Radiall sales

UNINSULATED PANEL SOCKETS (DP)

FIGURE	PART NUMBER	DESCRIPTION	PANEL DRILLING
	R941 619 000	Solder cup Cable tripping dimension 4mm (14AWG)	P01
	R941 629 000 (nickel plated version)		

INSULATED PANEL SOCKETS (DPI)

FIGURE	PART NUMBER	COLOR	DESCRIPTION	PANEL DRILLING
	R941 920 001	Black	Tin-plated solder cup UL 94V-0 thermoplastic insulation	P06
	R941 921 001	Red		
	R941 922 001	Green		
	R941 923 001	Blue		
	R941 924 001	Yellow		
	R941 926 001	White		

PATCH CORDS

Except where specified, all patch cords lengths are defined by the length of the cable without connectors or strain relief.

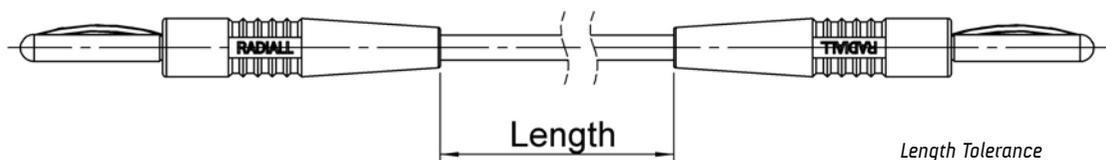

Length Tolerance  
 ±1 cm for patch cords ≤100 cm  
 ±1% for patch cords >100 cm

Radiall Patch Cord Series includes:

- **BM/BM:** Molded extension patch cords
- **BDM/BDM:** Molded stackable patch cords
- **PTM/BM:** Molded test probe patch cords
- **Patch cords made-to-order**

To download data sheets, visit [www.radiall.com](http://www.radiall.com)  
 For other specific demand, please contact Radiall sales

[www.radiall.com](http://www.radiall.com)

## PATCH CORDS

### EXTENSION PATCH CORDS (BM/BM)

Cable type: PVC, 1 mm<sup>2</sup> conductor, 3.5 mm insulation.



#### R 948 0xx 000

Patch cords length:  
 2 : 20 cm  
 4 : 50 cm  
 5 : 100 cm  
 6 : 150 cm  
 7 : 200 cm

Colour:  
 0 : Black  
 1 : Red  
 2 : Green  
 3 : Blue

### STACKABLE PATCH CORDS (BDM/BDM)

Cable types:

PVC, 1 mm<sup>2</sup>, 3.5 mm insulation.

PVC, 2 mm<sup>2</sup> conductor, 2.5 mm insulation.

Silicone, 2.5 mm<sup>2</sup> conductor, 4 mm insulation.



#### R948 1xx 0xx

Patch cords length:  
 3 : 25 cm  
 4 : 50 cm  
 5 : 100 cm  
 6 : 150 cm  
 7 : 200 cm

Colour:  
 0 : Black  
 1 : Red  
 2 : Green  
 3 : Blue  
 4 : Yellow

Cable type:  
 00 : PVC 1 mm<sup>2</sup> 3.5 mm  
 02 : PVC 2 mm<sup>2</sup> 3.5 mm  
 29 : Silicone 2.5 mm<sup>2</sup> 4 mm

### TEST PROBE PATCH CORDS (PTM/BM)

Cable types: PVC, 1 mm<sup>2</sup>, 3.5 mm insulation.



PART NUMBER	COLOUR	CORD LENGTH
R948 250 000	Black	100 cm
R948 251 000	Red	100 cm

## MADE-TO-ORDER PATCH CORDS

This series comprises the following extremities: BM, BDM, DM.  
 Choices include connector style, cable type, color, and cable length.

### HOW TO ORDER

Connector 1	Cable Type	Length	Connector 2
<b>BM type</b> R949 000/Black R949 001/Red R949 003/Blue <b>BDM type</b> R949 100/Black R949 101/Red <b>DM type</b> R949 500/Black R949 501/Red	<b>PVC 1 mm<sup>2</sup> cross section:</b> C 290 11x x = 0: Black, 1: Red, 2: Green, 3 :Blue, 4: Yellow <b>PVC 2mm<sup>2</sup> cross section :</b> C 290 10x x = 0: Black, 1: Red, 2: Green, 3:Blue, 4: Yellow	<b>xxx cm:</b> over cable length in centimeter	

**BM type** R949 000/Black  
 R949 001/Red  
 R949 003/Blue  
**BDM type** R949 100/Black  
 R949 101/Red  
**DM type** R949 500/Black  
 R949 501/Red

**For free end:** please write the word “free”.

**EXAMPLE TO ORDER:**

1 black BDM plug/green PVC 1 mm<sup>2</sup> with 80 cm length/1 red BDM plug  
 Part number: **R949 100/C290 112-80 cm/R949101**

For other specific demand, please contact Radiall sales

## ACCESSORIES

## FEMALE/FEMALE ADAPTERS

These adapters allow for the connection between two standard patch cords with BM extremities.

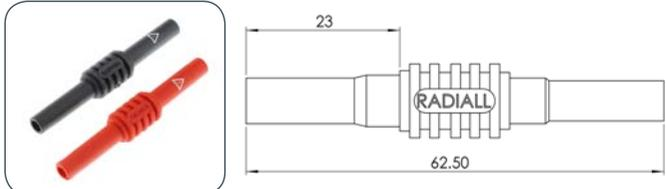
FIGURE	PART NUMBER	COLOUR
	R941 960 000	Black
	R941 961 600	Red

## TEST CLIPS

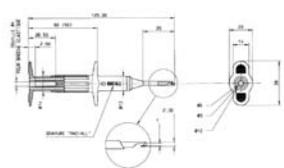
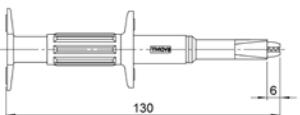
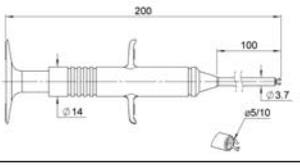
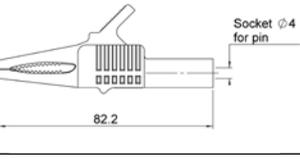
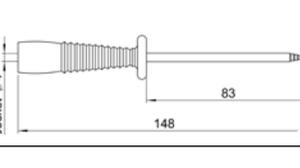
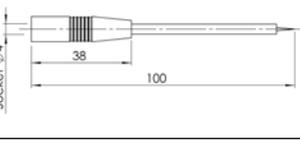
FIGURE	DESCRIPTION	PART NUMBER	COLOR	SERIES
 	With sliding hook	R999 700 600	Black	4 mm Safety series
		R999 701 600	Red	
 	With Alligator Test Clip	R999 710 600	Black	
		R999 711 600	Red	
 	With Flexible Steel Rod Test Clip	R999 720 600	Black	
		R999 721 600	Red	
 	With Crocodile Test Clip	R995 376 600	Black	
		R995 376 601	Red	
 	Safety Test Probe	R941 850 600	Black	
		R941 851 600	Red	
 	Safety Test Probe	R941 850 000	Black	4 mm Standard series
		R941 851 000	Red	

Radiall's high-quality and reliable 2 mm Series are designed for high-density test and measurement applications. This series includes a wide range of plugs, sockets, patch cords, test accessories, multiway connectors, short-circuit link, and other configurations.

- Plugs
- Sockets
- Patch cords
- PCB test points
- 20-way fixed connector
- Short circuit links
- Contact block and ribbon patch cords
- Accessories

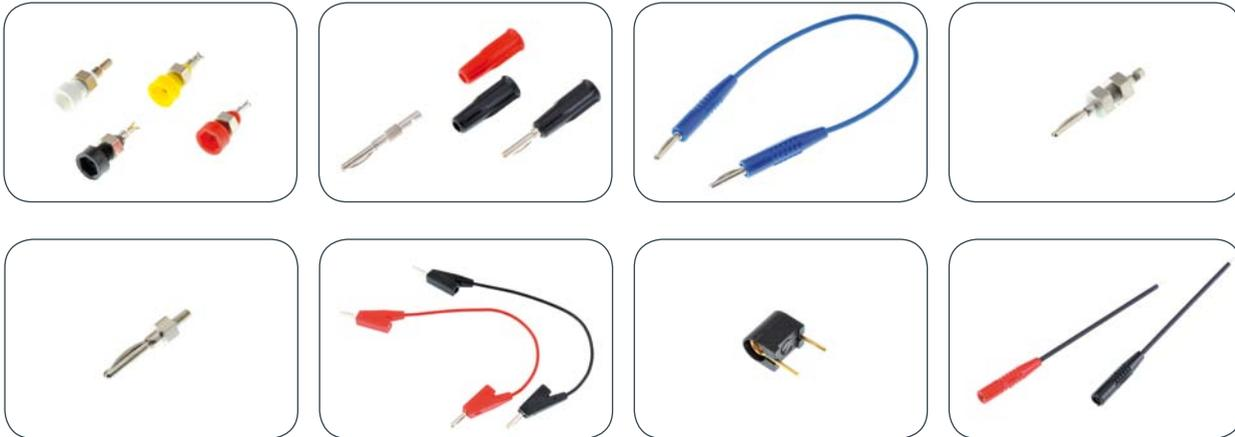

## 20-WAY FIXED CONNECTORS



These connectors contain twenty 2 mm sockets molded into a low-profile housing. The tight pitch between sockets makes them particularly suitable for use in circuit beakers and test batteries.

### Advantages:

- Quick assembly time with single mounting operation for multi-connections
- Space savings
- Simplified panel piercing
- Orientation of solder shafts

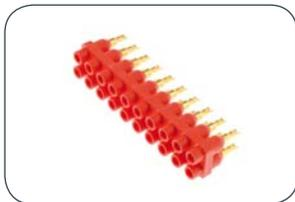

Has the potential to be able to remove the cable harness without disconnecting each socket.

## SHORT-CIRCUIT U LINKS



The short-circuit U link is a complementary component to the 20-way fixed connector and can be used to make shunts. It is fitted with a rear-mounted 2 mm socket.

To download data sheets, visit [www.radiall.com](http://www.radiall.com)  
For other specific demand, please contact Radiall sales

[www.radiall.com](http://www.radiall.com)

## INTRODUCTION

### 2 mm CONTACT BLOCKS AND RIBBON PATCH CORDS SERIES

This series includes: contact blocks, ribbon patch cords and polarized ribbon patch cords.

Dimensions of contact outlets and projections.

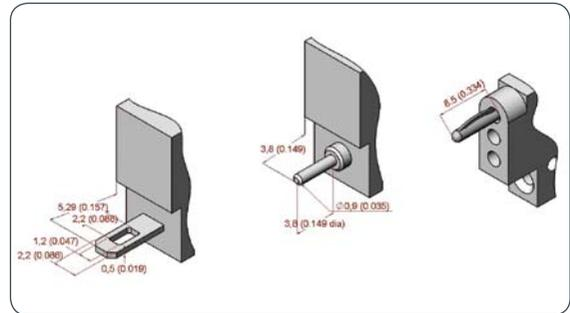
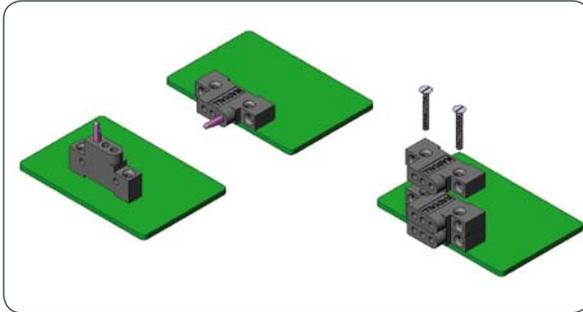

### RIBBON PATCH CORDS



The contact blocks can mate with ribbon patch cords which have:

- excellent contact
- sturdy construction
- contact polarization options
- low bulk
- high retention

They can be used for several field applications such as: electronics, laboratories, education and telecommunications, etc.

### ACCESSORIES PCB TEST SOCKET

Test sockets simplify testing and maintenance of equipment where direct contact with components should be avoided.

- **Test Socket entrax 10.16 mm:** This model with the particular disposition of the pins allows the unmobilization on the circuit board. This version is particularly adapted for a wave soldering operation.
- **Test Socket entrax 5.08 mm:** This test socket is made up of a joined spiral spring with a nickel over plated protection.

### ACCESSORIES TEST PROBE

An extra thin probe allows contact through coatings and some insulations. It can also be used for PCB measurements. Fitted with a rear-mounted 2 mm socket, it can be used with BLM and BLDM patch cords.

PLUGS	SOCKETS	PATCH CORDS
-------	---------	-------------

## ELECTRICAL

Current rating, max.	10 A (at 20°C)	PVC cable 0.3mm <sup>2</sup> section 5 A (at 20°C)
Dielectric withstanding voltage	1500 Vrms 50 Hz	
Operating voltage	250 Vrms 50 Hz	
Insulation resistance, min	5000 MΩ	
Contact resistance, max	1 mΩ	

## MECHANICAL

Mechanical endurance, min	10000 matings
Average insertion force	14 N

## ENVIRONMENTAL

Temperature range	Uninsulated -65°C/+155°C Insulated models -60°C/+100°C	-40°C/+70°C
-------------------	---	-------------

## MATERIAL

Insulation	Thermoplastic
Contacts	Nickel or tin plated Copper alloy/brass

20-WAY FIXED CONNECTOR	SHORT-CIRCUIT U LINKS
------------------------	-----------------------

## ELECTRICAL CHARACTERISTICS

Current rating, max.	7 A (at 20°C)	
Dielectric withstanding voltage	2000 Vrms 50 Hz	
Operating voltage	500 Vrms 50 Hz	
Insulation resistance	5000 MΩ	

## MECHANICAL

Mechanical endurance	10,000 matings	
----------------------	----------------	--

## ENVIRONMENTAL

Temperature range	-40°C/+125°C	-40°C/+70°C
-------------------	--------------	-------------

## MATERIAL

Insulation	Self-extinguishable PBT UL 94V0	PVC
Contacts	Brass with gold plating	Brass/Bronze

To download data sheets, visit [www.radiall.com](http://www.radiall.com)

# CHARACTERISTICS

## CONTACT BLOCKS & RIBBON PATCH CORDS

### ELECTRICAL

Current rating, max.	
Contact blocks	7 A (@ 20°C)
Ribbon patch cords	5 A (@ 20°C)
Dielectric withstanding voltage	1500 Vrms 50 Hz
Operating voltage	250 Vrms 50 Hz
Insulation resistance (Insulated models)	5000 MΩ
Contact resistance	1mΩ

### MECHANICAL

Endurance	> 10 000 matings
-----------	------------------

### ENVIRONMENTAL

Temperature range	
Contact blocks	-65°C/+120°C
Ribbon patch cords	-40°C/85°C

### MATERIAL

Insulation	Thermoplastic
Body	Nickel or tin plated (solder connection) Copper alloy/Brass

## ACCESSORIES

### PCB TEST SOCKETS

### TEST PROBE

### ELECTRICAL

Dielectric withstandard voltage		1000 Vrms
Extra 10.16 model	1500 Vrms 50 Hz	
Other models	1000 V	
Operating voltage	250 Vrms 50 Hz	250 Vrms 50 Hz

### MECHANICAL

Insulation resistance	10000 MΩ	5000 MΩ
-----------------------	----------	---------

### ENVIRONMENTAL

Operating temperature	-40°C/+100°C	-25°C/70°C
-----------------------	--------------	------------

## PACKAGING

DESCRIPTION	PACKAGING
Plugs	100 pieces (except BDR-2 = 10 pieces)
PCB test sockets	100 pieces
Patch cords	10 pieces
20-way fixed connector	1 piece
Short-circuit u links	100 pieces
PCB test sockets	100 pieces
Test probe	10 pieces
Contact blocks	50 pieces
Ribbon patch cords	10 pieces

UNINSULATED BANANA PLUGS

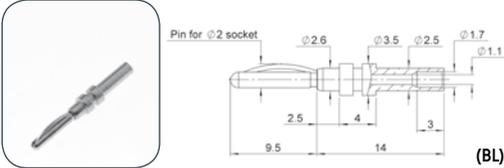
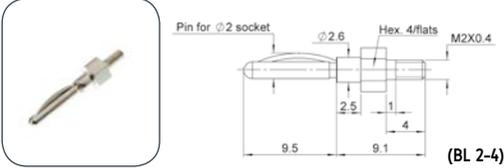
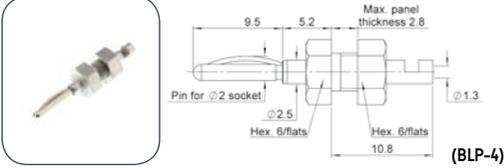
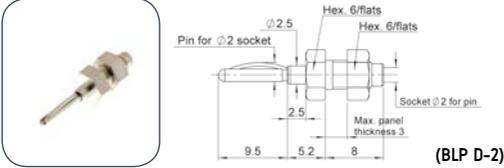
FIGURE	PART NUMBER	DESCRIPTION	PANEL DRILLING
	R921 019 000	Solder or crimp Strip length: 4 mm Crimp tool: Buchanan R612 548 000 Positioner Radiall R282 982 000 Cable: AWG 20, 22, 24	
	R921 029 000	Threaded Rear length 4 mm	
	R921 119 000	Nut - tin-plated solder Strip length: 4 mm Cable: AWG 20	P03
	R921 149 000	Male-female adapter with nut	P03

INSULATED BANANA PLUGS

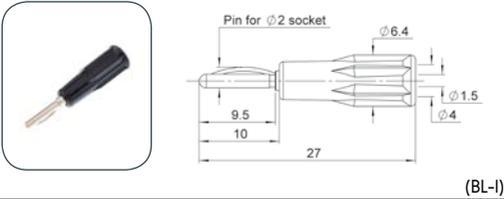
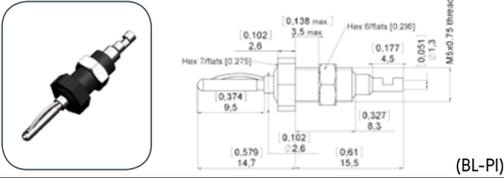
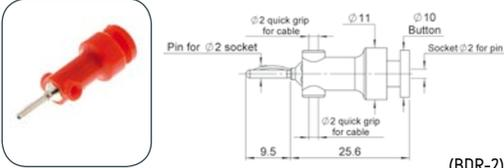
FIGURE	PART NUMBER	COLOR	REAR TERMINATION OPTIONS	PANEL DRILLING
	R921 330 000	Black	Tin-plated solder Cable: AWG 20	
	R921 331 000	Red		
	R921 332 000	Green		
	R921 333 000	Blue		
	R921 334 000	Yellow		
	R921 336 000	White		
	R921 420 000	Black	Panel mount with tin-plated solder Cable: AWG 20	P02
	R921 461 000	Red	Stackable plug with quick grip clamp 2 mm rear socket	

To download data sheets, visit [www.radiall.com](http://www.radiall.com)  
For other specific demand, please contact Radiall sales

# SOCKETS

## UNINSULATED BANANA SOCKETS

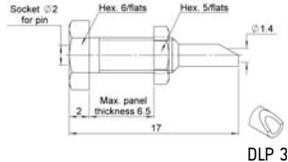
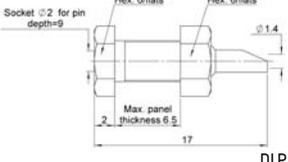
FIGURE	PART NUMBER	REAR TERMINATION OPTIONS	PANEL DRILLING
  <p>DLP 3.5</p>	R921 609 000	Tin-plated solder Panel mount: M3.5 x 0.35 thread Strip length: 4 mm Cable: AWG 20	P04
 <p>DLP 4</p>	R921 629 000	Tin-plated solder Panel mount: M4 x 0.5 thread Strip length: 4 mm Cable: AWG 20	P03

## INSULATED BANANA SOCKETS

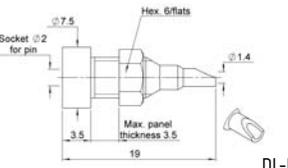
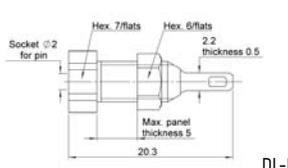
FIGURE	PART NUMBER	COLOR	TERMINATION	PANEL DRILLING
  <p>DL-PI</p>	R921 920 000	Black	Machined panel-mount socket Tin-plated solder termination Strip length: 4 mm Cable: AWG 20	P02
	R921 921 000	Red		
	R921 922 000	Green		
	R921 923 000	Blue		
	R921 924 000	Yellow		
  <p>DL-PI</p>	R921 926 000	White	Stamped panel-mount socket Tin-plated solder termination Strip length: 4 mm AWG 20 wire	P02
	R921 930 000	Black		
	R921 931 000	Red		
	R921 932 000	Green		
	R921 933 000	Blue		
	R921 934 000	Yellow		
R921 936 000	White			

# PATCH CORDS

Except where specified, all patch cords lengths are defined by the length of the cable without connectors or strain relief.

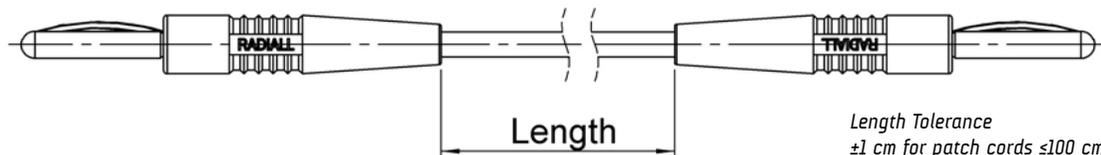

*Length Tolerance*  
±1 cm for patch cords ≤100 cm  
±1% for patch cords >100 cm

Radiall Patch Cord Series includes:

- **BLM:** Molded miniature extension patch cords
- **BMDM:** Molded miniature stackable patch cords
- **Patch cords made-to-order**

Each plug is soldered onto the cable in order to assure an excellent electrical connection with very stable transfer resistance.

**Molded Extension (BLM)**

Cable: pvc cable 0,3 mm<sup>2</sup>.



**R928 0xx 000**

Patch cords length: 1 : 10 cm 5 : 100 cm	Colour: 0 : Black 1 : Red 3 : Blue
--	---

**Molded Stackable (BLDM)**

Cable: pvc cable 0,3 mm<sup>2</sup>.

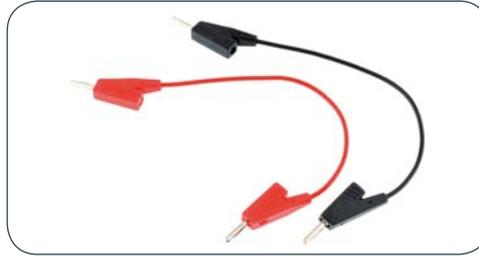

**R928 1xx 000**

Patch cords length: 1 : 10 cm 2 : 20 cm 4 : 50 cm 5 : 100 cm	Colour: 0 : Black 1 : Red 2 : Green 3 : Blue 4 : Yellow
--	--

**PATCH CORDS MADE TO ORDER**

Customized patch cords using BLM, BLDM, or DLM plugs can be made-to-order to your specifications. Choices include connector style, cable type, color, and cable length. Packaging : 10 identical patch cords.

**HOW TO ORDER**

Connector 1	Cable Type	Length	Connector 2
-------------	------------	--------	-------------

**BLM type** R929 000/Black  
R929 001/Red

**BDLM type** R929 100/Black  
R929 101/Red

**DLM type** R929 500/Black  
R929 501/Red

**PVC section 0.3mm<sup>2</sup>:** C 290 00x  
x = 0: Black, 1: Red, 2: Green, 3: Blue, 4: Yellow

**xxx cm:** cable length in centimeter

**BM type** R929 000/Black  
R929 001/Red

**BDM type** R929 100/Black  
R929 101/Red

**DM type** R929 500/Black  
R929 501/Red

For free end: please write the word "free".

**EXAMPLE TO ORDER:**

1 black BLM extremity/ red PVC cable length 40 cm/ 1 red DLM plug  
Part number: R929 000/C290 001 - 40 cm/R929 501

For other specific demand, please contact Radiall sales

# 20-WAY FIXED CONNECTORS

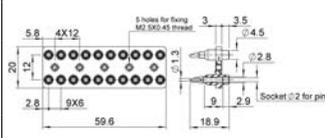
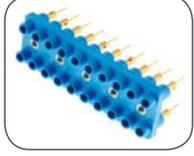
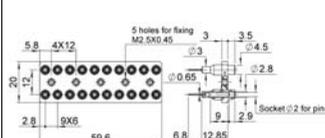
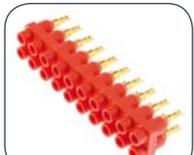
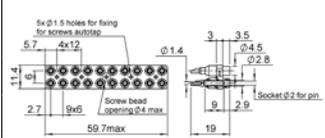
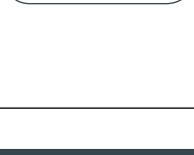
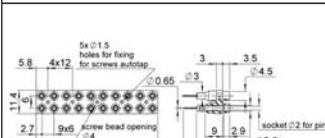
12 mm CONTACT PITCH				
		R929 991 000	Blue	Solder Cup
		R929 991 001	Red	
		R929 991 002	Green	
		R929 991 003	Black	
		R929 991 004	Yellow	
		R929 992 000	Blue	Pin
6 mm CONTACT PITCH				
		R929 993 000	Blue	Solder Cup
		R929 993 001	Red	
		R929 993 002	Green	
		R929 993 003	Black	
		R929 993 004	Yellow	
		R929 994 003	Black	Pin

# SHORT-CIRCUIT U LINK

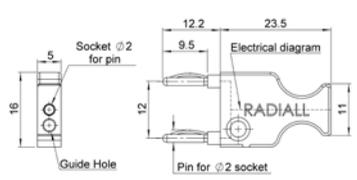
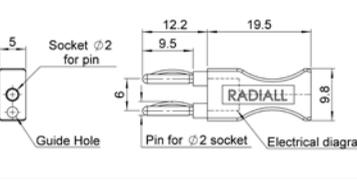
12 mm CONTACT PITCH				
		R644 543 000	Blue	Solder Cup
		R644 543 001	Red	
		R644 543 002	Green	
		R644 543 003	Black	
		R644 543 004	Yellow	
6 mm CONTACT PITCH				
		R644 543 020	Blue	Solder Cup
		R644 543 021	Red	
		R644 543 022	Green	
		R644 543 023	Black	
		R644 543 024	Yellow	

The contact blocks are available for different types of connections:

- Wire soldering
- Straight pins for PCB
- Elbow pins for PCB (contact your Radiall sales representative)
- Wrapping pins (contact your Radiall sales representative)

## Male Contact Blocks

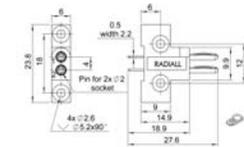
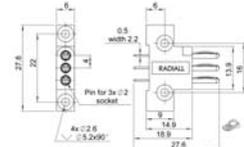
FIGURE	PART NUMBER	NOTE
	 (FL 2M)	Tin-plated solder cup
	 (FL 3M)	

## Female Contact Blocks

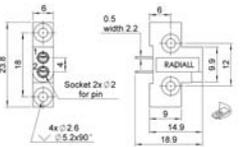
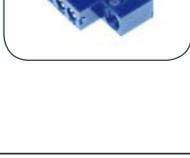
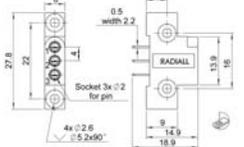
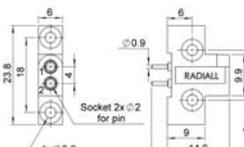
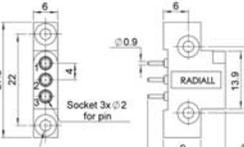
FIGURE	PART NUMBER	NOTE
	 (FL 2F)	Tin-plated solder cup
	 (FL 3F)	
	 (FL 2F-CI)	PCB Pins
	 (FL 3F-CI)	

To download data sheets, visit [www.radiall.com](http://www.radiall.com)  
For other specific demand, please contact Radiall sales

## RIBBON PATCH CORDS

Ribbon patch cords are fitted with crimped, non-removable contacts. The connector ends are molded onto a ribbon cable composed of several cables connected by thermoplastic sealing. The patch cords can be mated with FL contact blocks.

### Male-Male Ribbon patch cords 100 cm Lengths

FIGURE	PART NUMBER	DESIGNATION	NUMBER OF CONTACT
	R644 823 000	ML 2 MM	2
	R644 833 000	ML 3 MM	3

### Female-Female Ribbon patch cords

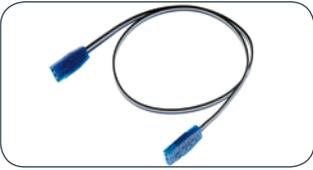
FIGURE	PART NUMBER	DESIGNATION	NUMBER OF CONTACT
	R644 828 000	ML 2 FF	2
	R644 838 000	ML 3 FF	3

## POLARIZED CONTACT BLOCKS

### MADE-TO-ORDER POLARIZED CONTACT BLOCKS

Polarized contact blocks include male and female contacts in the same housing. The polarization of contact block is based on an indicator at contact n°1.

*All polarized contact blocks are made to order. Please contact Radiall sales for delivery time.*

FIGURE	PART NUMBER	NUMBER OF CONTACT	DESIGNATION
	R644 220 (...)	2	Outlet wire solder
	R644 240 (...)	4	

#### EXAMPLE TO ORDER:

1 contact block with 2 contacts: 1 male contact (position 1) + 1 female contact (position 2).

Part number: **R644 220 (1M + 1F)**

To download data sheets, visit [www.radiall.com](http://www.radiall.com)  
For other specific demand, please contact Radiall sales

# POLARIZED RIBBON PATCH CORDS

## HOW TO ORDER

Connector 1	Cable Type	Length	Connector 2
-------------	------------	--------	-------------

**Polarized connector with:**  
 - 2 contacts: R644 596 (...)  
 - 4 contacts: R644 598 (...)

**Cable 2 conductors:** C290 400  
**Cable 4 conductors:** C290 420

**xxx cm:** length in centimeter

**Polarized connector with:**  
 - 2 contacts: R644 596 (...)  
 - 4 contacts: R644 598 (...)

**EXAMPLE TO ORDER:**

One ribbon patch cord composed of two male contacts and two female contacts on one connector, a cable length 175 cm, one connector with the same polarity on the other end.  
 Part number: R644 598 (2M+2F)/C290 420 - 175 cm/R644 598 (2M+2F) (see the below figure 1)

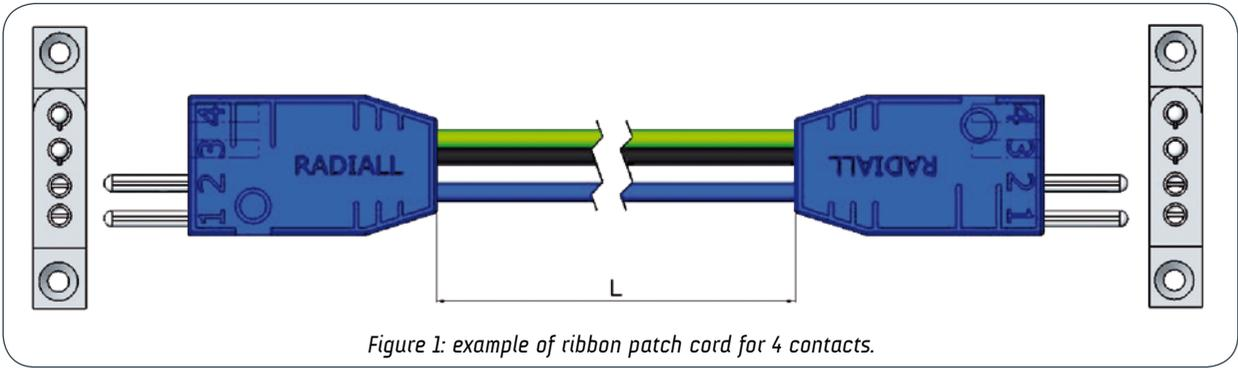
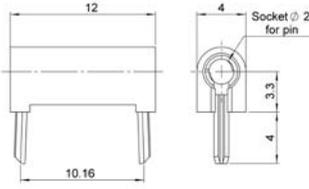
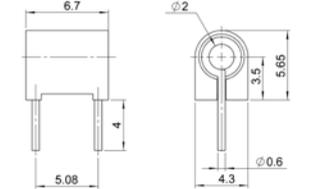
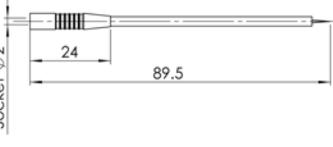

Figure 1: example of ribbon patch cord for 4 contacts.

To download data sheets, visit [www.radiall.com](http://www.radiall.com)  
 For other specific demand, please contact Radiall sales

ACCESSORIES

TEST SOCKETS AND TEST PROBE

FIGURE	PART NUMBER	COLOR	DESCRIPTION
 	R921 910 000	Black	Test socket entrax 10.16 mm
	R921 911 000	Red	
	R921 912 000	Green	
	R921 913 000	Blue	
	R921 914 000	Yellow	
	R921 916 000	White	
 	R921 820 070	Black	Test socket entrax 5.08 mm
	R921 820 071	Red	
	R921 820 072	Green	
	R921 820 073	Blue	
	R921 820 074	Yellow	
	R921 820 076	White	
 	R921 850 000	Black	Test probe
	R921 851 000	Red	

To download data sheets, visit [www.radiall.com](http://www.radiall.com)  
 For other specific demand, please contact Radiall sales

# INTRODUCTION

The connection may be attached to a coaxial line. You will find at the end of the catalog the adapters which allow connecting between 2 mm and 4 mm or between BNC coaxial connectors with banana plugs for both 2 mm and 4 mm connectors.



# CHARACTERISTICS

2 mm/4 mm ADAPTER	BNC/2 mm ADAPTER	BNC/4 mm ADAPTER	ADAPTER PATCH CORDS
-------------------	------------------	------------------	---------------------

**ELECTRICAL**

Current rating, max.	10 A (at 20°C)		5 A (at 20°C)
Dielectric withstanding voltage	1500 Vrms at 50 Hz	Two-way: 2500 Vrms at 50 Hz One-way: 750 Vrms at 50 Hz	1500 Vrms at 50 Hz
Operating voltage	250 Vrms at 50 Hz		250 Vrms at 50 Hz
Insulation resistance, min.	5000 MΩ	Two-way: 5000 MΩ One-way: 5000 MΩ	5000 MΩ

**ENVIRONMENTAL**

Temperature range	-40/+70°C	-40/+100°C	-40/+70°C
-------------------	-----------	------------	-----------

**MATERIAL**

Insulator (banana plug/socket side)	Thermoplastic
Electrical contacts	Nickel or tin plated Copper alloy/brass

# PACKAGING

DESCRIPTION	PACKAGING
2 mm /4mm	100 pieces
BNC/2 mm	1 piece
BNC/4 mm	1 piece
Patch cords	10 pieces

# ADAPTERS

## 2 mm Pin to 4 mm SOCKET ADAPTERS

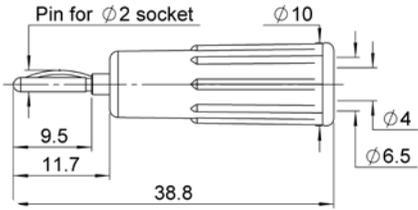
FIGURE	PART NUMBER	COLOR	NOTE
 	R921 390 000	Black	2 mm male - 4 mm female adapter
	R921 391 000	Red	

## 2 mm to BNC ADAPTERS

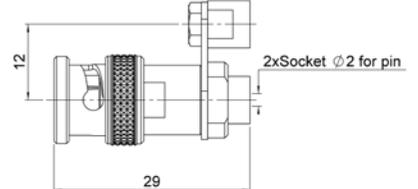
FIGURE	PART NUMBER	COLOR	NOTE
 	R191 450 000	Black	Packaging individually

## 4 mm to BNC ADAPTERS

These adaptors are designed to uncouple electric signals from input and output terminals of a measuring device fitted with male or female BNC fixed connectors.

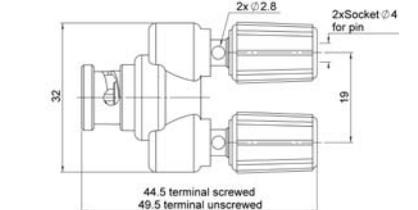
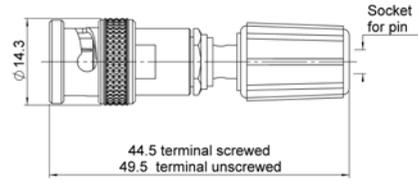
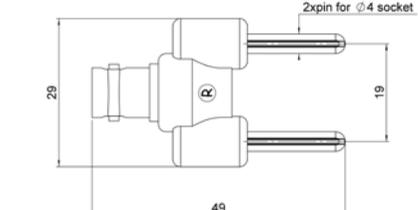
FIGURE	PART NUMBER	NOTE
 	R191 453 000	BNC: male Banana: two 4 mm sockets
 	R191 454 000	BNC: male Banana: one 4 mm socket
 	R191 455 000	BNC: female Banana: two 4 mm plugs

### BANANA ADAPTER PATCH CORDS

Patch cords are designed to provide continuity between two pieces of equipment or create patch cords with 2 mm interfaces on one end and 4 mm interface on the other.

Cable Type: 0.3 mm<sup>2</sup>, PVC

FIGURE	PART NUMBER	COLOR	CONFIGURATION
	R999 251 000	Red	BLM/BM 100 cm length
	R999 350 000	Black	BLDM/BDM 100 cm length
	R999 351 000	Red	
	R999 352 000	Green	
	R999 353 000	Blue	
	R999 354 000	Yellow	
	R999 520 000	Black	BLM/DM 20 cm length
	R999 521 000	Red	

### COAXIAL PATCH CORDS/4 mm BANANA PLUG

#### BCX Coaxial Patch Cords

The BCX coaxial cords are normally connected to the terminals of measuring devices in order to uncouple the central core from the braid of a coaxial cable. The BCX plug is non-removable. The cable core is soldered to the center contact and the braid is soldered to the socket.

FIGURE	PART NUMBER	COLOR	CONFIGURATION
	R948 450 000	Black	Length: 100 cm (with connectors)

PANEL DRILLING

P01

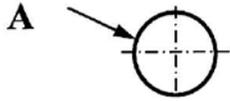

mm		
	Maxi	mini
A	6.2	6.1

P02



mm		
	Maxi	mini
A	5.2	5.1

P03



mm		
	Maxi	mini
A	4.2	4.1

P04



mm		
	Maxi	mini
A	3.7	3.6

P05

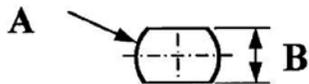

mm		
	Maxi	mini
A	12.2	12.1
B	11.2	11.1

P06

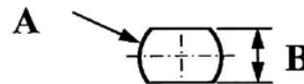

mm		
	Maxi	mini
A	8.2	8.1
B	7.2	7.1

## PART NUMBER INDEX

R191 450 000.....32	R921 420 000.....23	R929 993 003..... 26	R941 921 001.....15
R191 453 000.....32	R921 461 000.....23	R929 993 004..... 26	R941 921 600.....11
R191 454 000.....32	R921 609 000.....24	R929 994 003..... 26	R941 921 602.....11
R191 455 000.....32	R921 629 000.....24		R941 921 603.....11
	R921 820 070.....30	R941 019 000..... 14	R941 922 001.....15
R644 020 000.....27	R921 820 071.....30	R941 029 000..... 14	R941 922 600.....11
R644 030 000.....27	R921 820 072.....30	R941 049 000..... 14	R941 923 001.....15
R644 120 000.....27	R921 820 073.....30	R941 069 000..... 14	R941 923 600.....11
R644 121 000.....27	R921 820 074.....30	R941 149 000..... 14	R941 924 001.....15
R644 130 000.....27	R921 820 076.....30	R941 330 000..... 14	R941 924 600.....11
R644 131 000.....27	R921 850 000.....30	R941 331 000..... 14	R941 924 603.....11
R644 220 (...).28	R921 851 000.....30	R941 332 000..... 14	R941 926 001.....15
R644 240 (...).28	R921 910 000.....30	R941 333 000..... 14	R941 960 000.....18
R644 543 000.....26	R921 911 000.....30	R941 334 000..... 14	R941 961 600.....18
R644 543 001.....26	R921 912 000.....30	R941 336 000..... 14	
R644 543 002.....26	R921 913 000.....30	R941 340 000..... 14	R948 250 000.....16
R644 543 003.....26	R921 914 000.....30	R941 341 000..... 14	R948 251 000.....16
R644 543 004.....26	R921 916 000.....30	R941 342 000..... 14	R948 450 000.....33
R644 543 020.....26	R921 920 000.....24	R941 343 000..... 14	
R644 543 021.....26	R921 921 000.....24	R941 344 000..... 14	R995 376 600.....18
R644 543 022.....26	R921 922 000.....24	R941 346 000..... 14	R995 376 601.....18
R644 543 023.....26	R921 923 000.....24	R941 460 000..... 14	
R644 543 024.....26	R921 924 000.....24	R941 460 600..... 11	R999 251 000.....33
R644 823 000.....28	R921 926 000.....24	R941 461 000..... 14	R999 350 000.....33
R644 828 000.....28	R921 930 000.....24	R941 461 600..... 11	R999 351 000.....33
R644 833 000.....28	R921 931 000.....24	R941 462 600..... 11	R999 352 000.....33
R644 838 000.....28	R921 932 000.....24	R941 463 600..... 11	R999 353 000.....33
	R921 933 000.....24	R941 464 600..... 11	R999 354 000.....33
R921 019 000.....23	R921 934 000.....24	R941 480 600..... 11	R999 520 000.....33
R921 029 000.....23	R921 936 000.....24	R941 481 600..... 11	R999 521 000.....33
R921 119 000.....23		R941 619 000..... 15	R999 700 600.....18
R921 149 000.....23	R929 991 000..... 26	R941 629 000..... 15	R999 701 600.....18
R921 330 000.....23	R929 991 001..... 26	R941 850 000..... 18	R999 710 600.....18
R921 331 000.....23	R929 991 002..... 26	R941 850 600..... 18	R999 711 600.....18
R921 332 000.....23	R929 991 003..... 26	R941 851 000..... 18	R999 720 600.....18
R921 333 000.....23	R929 991 004..... 26	R941 851 600..... 18	R999 721 600.....18
R921 334 000.....23	R929 992 000..... 26	R941 920 001..... 15	
R921 336 000.....23	R929 993 000..... 26	R941 920 600..... 11	
R921 390 000.....32	R929 993 001..... 26	R941 920 602..... 11	
R921 391 000.....32	R929 993 002..... 26	R941 920 603..... 11	



**AEROSPACE**



**AUTOMOTIVE**



**DEFENSE**



**INDUSTRIAL**



**INSTRUMENTATION**



**MEDICAL**



**SPACE**



**TELECOM**

## EUROPE

### France - RADIALL S.A.

101, Rue Ph. Hoffmann  
93116 ROSNY sous BOIS (Paris)  
Tel.: +33 1 49 35 35 35 - Fax: +33 1 48 54 63 63  
E-Mail: info@radiall.com

### Finland - RADIALL SF

P.O. Box 202 - 90101 OULU  
Tel.: +358 407 522 412  
E-Mail: infofi@radiall.com

### Germany - RADIALL GmbH

Carl-Zeiss Str. 10 Postfach 200143  
D63307 - RÖDERMARK (Frankfurt)  
Tel.: +49 60 74 91 07 0 - Fax: +49 60 74 91 07 70  
E-Mail: infode@radiall.com

### Italy - RADIALL Elettronica S.R.L.

Via Concordia, 5 - 20090 ASSAGO MILANO  
Tel.: +39 02 48 85 121 - Fax: +39 02 48 84 30 18  
E-Mail: infoit@radiall.com  
Regional office: Roma

### Netherlands - RADIALL B.V.

Hogebrenkerweg 15b - 3871 KM HOEVELAKEN  
Tel.: +31 33 253 40 09 - Fax: +31 33 253 45 12  
E-Mail: infofl@radiall.com

### Sweden - RADIALL A.B.

Sjöängsvägen 2 - SE-192 72 SOLLENTUNA (Stockholm)  
Tel.: +46 844 434 10 - Fax: +46 875 449 16  
E-Mail: infose@radiall.com

### U.K. - RADIALL Ltd.

Ground Floor, 6 The Grand Union Office Park,  
Packet Boat Lane  
UXBRIDGE Middlesex UB8 2GH (London)  
Tel.: +44 1895 425 000 - Fax: +44 1895 425 010  
E-Mail: infouk@radiall.com

## NORTH AMERICA

### USA - RADIALL USA, Inc.

6825 West Galveston Street  
CHANDLER, Arizona 85226  
Tel.: +1 480 682 9400 - Fax: +1 480 682 9403  
E-Mail: infousa@radiall.com

## ASIA

### China - SHANGHAI RADIALL Electronic Co., Ltd.

N° 390 Yong He Road 200072 - SHANGHAI  
Tel.: +86 21 66 52 37 88 - Fax: +86 21 66 52 11 77  
E-Mail: infosh@radiall.com

### Japan - NIHON RADIALL

Shibuya-ku Ebisu 1-5-2, Kougetsu Bldg 405  
TOKYO 150-0013  
Tel.: +81 3 3440 6241 - Fax: +81 3 3440 6242  
E-Mail: infojp@radiall.com

### Hong Kong - RADIALL Electronics Ltd.

Flat D, 6/F, Ford Glory Plaza,  
37-39 Wing Hong Street  
Cheung Sha Wan  
KOWLOON HONG KONG  
Tel: +852-2959-3833 - Fax: +852-2959-2636  
E-Mail: infohk@radiall.com

### India - RADIALL India Pvt. Ltd.

25 D, II Phase, Peenya Industrial Area  
BANGALORE 560058  
Tel.: +91 80 83 95 271 - Fax: +91 80 83 97 228  
E-Mail: infoin@radiall.com

## ALSO REPRESENTED IN

Australia	Hungary	Poland
Austria	Indonesia	Russia
Belgium	Israel	Singapore
Brazil	Korea	Spain
Czech Republic	Latvia	Switzerland
Denmark	Lithuania	Taiwan
Estonia	Malaysia	Thailand
Greece	Norway	Vietnam
	Philippines	South Africa

For the above countries, please contact the local agent or RADIALL at info@radiall.com

## X-ON Electronics

Largest Supplier of Electrical and Electronic Components

*Click to view similar products for [Test Plugs & Test Jacks](#) category:*

*Click to view products by [Radiall](#) manufacturer:*

Other Similar products are found below :

[01-2601-4-0210](#) [01-2601-4-0212](#) [01-2604-4-0212](#) [01-2604-5-0210](#) [01-2150-1-0312](#) [01-2350-1-02](#) [01-2352-1-02](#) [01-2368-1-02](#) [01-2604-4-0210](#) [01-2604-5-0212](#) [01-2606-4-0210](#) [01-2606-4-0212](#) [01-2606-5-0212](#) [M39024/10-01G](#) [M39024/10-17G](#) [M39024/11-09G](#) [M39024/11-42](#) [M39024/11-43](#) [M39024/12-08](#) [707-5311](#) [707-5402-01-19](#) [707-5410](#) [923739-40-I](#) [R644543000](#) [R948161000](#) [R999351000](#) [1408-4](#) [1499-101](#) [1533-1](#) [1659559](#) [1659567](#) [1663921](#) [1663939](#) [1696-102](#) [174-R825B-EX](#) [NYS508-BU](#) [NYS508-O](#) [211-101](#) [RS100GBL](#) [RS250GBL](#) [251-102](#) [25-2251-2-03](#) [25-2259-2-03](#) [923743-16-I](#) [923743-24-I](#) [923743-28-I](#) [2854-BLU](#) [2970-BLK](#) [30-443G](#) [1680](#)