

# RCQ3-434-RM

- Multichannels Radio Modem

Frequency band : 430MHz ÷ 435MHz

## RCQ3-434-RM

based on RadioControlli RC-CC1310-434 component.



### - **Multichannels Radio Modem**

The modem operates in the band from 430MHz to 435MHz. The RF modem is very simple to use and provides a wireless RS232 link with a RF data rate of up to 100 kbps. The transceivers have the functions of a complete radio modem and simply require CMOS/TTL data at the transmit input and the corresponding transceiver(s) output the same data. Preamble and CRC are automatically generated and added to the RF transmission.

The RCQ3-434-RM can use any channel in 100 (200) KHz step. Possible applications include one-to-one and multi-node wireless links in applications including security, EPOS, wireless sensor network, industrial process monitoring and computer networking. It's possible to set the frequency **from 430MHz to 435MHz**.

### **Applications :**

- *Wireless security systems*
- *Home and building automation*
- *Automatic Measure Reading*
- *Industrial Control and Monitoring*
- *Wireless Sensor Network*
- *EPOS Terminal*

### **Feature :**

- *Radio Modems Application Inside*
- *Low consumption technology*
- *RF Data Rate up to 100Kbps*
- *RF Channel Selectable*
- *Serial Data Interface with Handshake*
- *Host Data Rate up to 115200 Baud*
- *Very Stable Operating Frequency*

# RCQ3-434-RM

- Multichannels Radio Modem  
Frequency band : 430MHz ÷ 435MHz

## 1.0 Connection

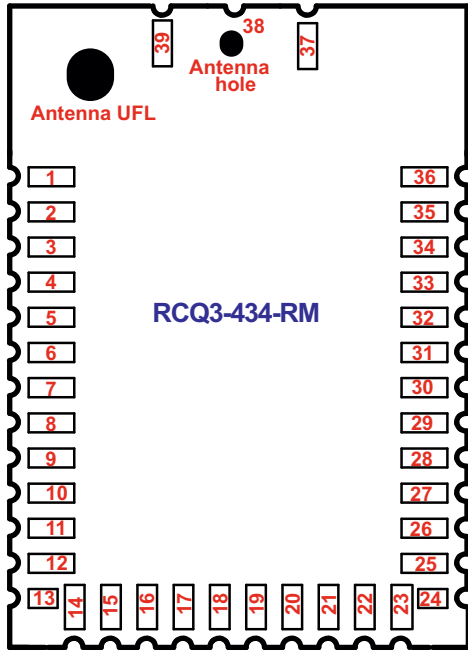

**Pin out device**

Pads	Name	Description
1	GND	Ground
2	NU	Not Used
3	RX	UART RX
4	TX	UART TX
5	NU	Not Used
6	NU	Not Used
7	NU	Not Used
8	NU	Not Used
9	GND	Ground
10	VDD	Power 3Volt
11	NU	Not Used
12	NU	Not Used
13	T1	Switck to generate the carrier
14	NU	Not Used
15	NU	Not Used
16	NU	Not Used
17	P1	Switch for Test Mode
18	NU	Not Used
19	NU	Not Used
20	NU	Not Used
21	NU	Not Used
22	NU	Not Used
23	NU	Not Used
24	NU	Not Used
25	01	Led Test Mode
26	RTS	UART RTS
27	CTS	UART CTS
28	RESET	RESET (Active low, No internal pull up)
29	NU	Not Used
30	NU	Not Used
31	NU	Not Used
32	NU	Not Used
33	NU	Not Used
34	NU	Not Used
35	NU	Not Used
36	NU	Not Used
37	GND	Ground
38	GND	Ground

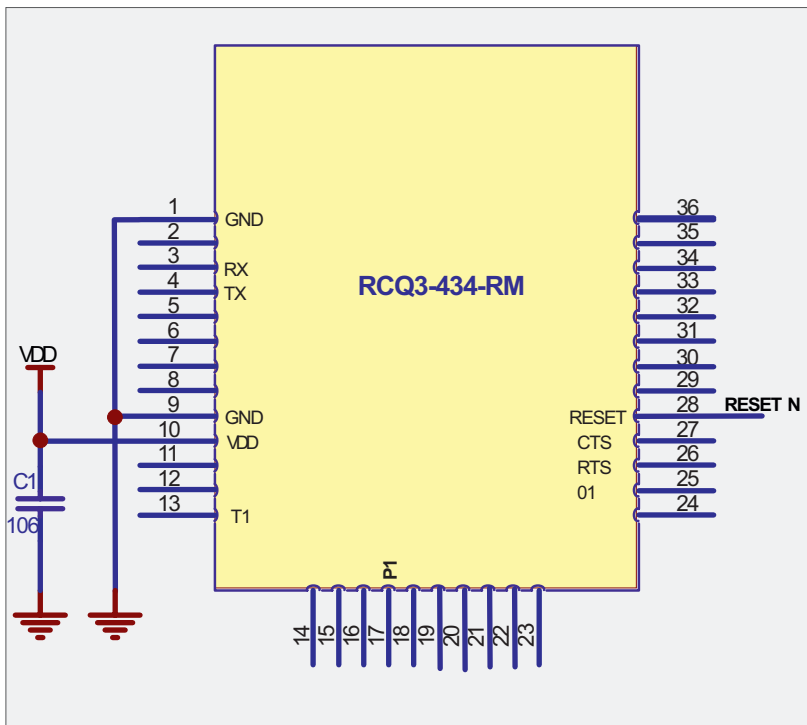

**Reference Schematics**

# RCQ3-434-RM

- Multichannels Radio Modem

Frequency band : 430MHz ÷ 435MHz

## 2.0 Mechanical Dimension

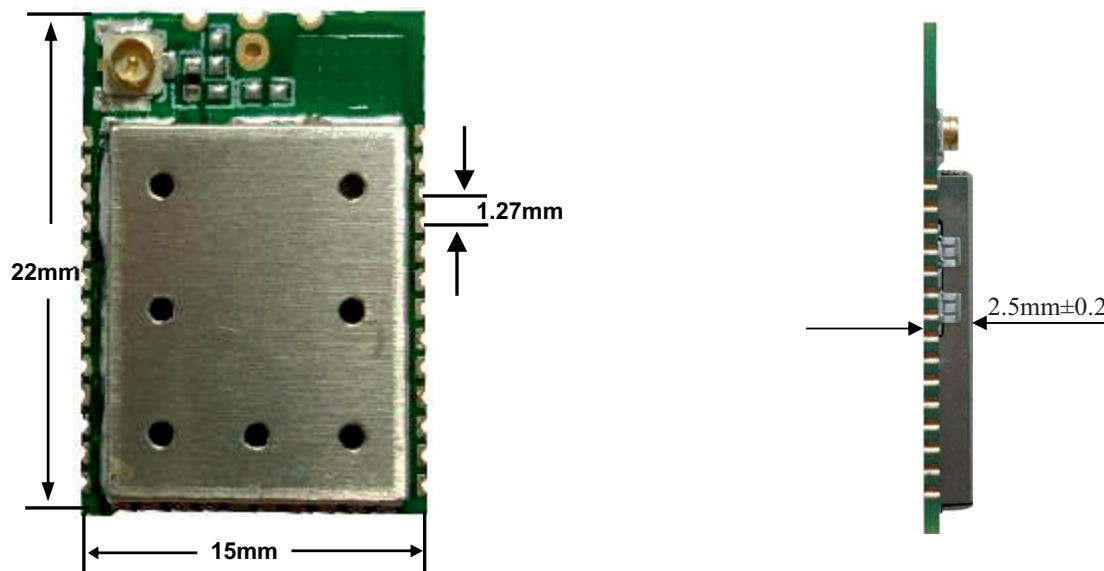

## 3.0 Technical Specifications

### Technical Characteristics

Characteristics	MIN	TYP	MAX	UNIT
Supply Voltage	1.8	3	3.6	VDC
Supply Current RX mode		5.5		mA
Supply Current TX mode ---> +10dBm		13.4		mA
Supply Current TX mode ---> +14dBm		23.5		mA
Supply Current Standby Mode		0.7		µA
Supply Current Shut Down Mode		185		nA
Operative Frequency		430-435		MHz
Frequency error		± 10		ppm
RF Power Output 50ohm (*)	-10		+14	dBm
RF Sensitivity 50kbps		- 110		dBm
RF Sensitivity (Long Range Mode 625bps)		- 124		dBm
Data Rate	0,01		4	Mbit/s
Operative Temperature	-30			

(\*) Programmable parameter,

WARNING it is recommended use this device in accordance with the CEPT/ERC REC 70-03

## 4.0 Multichannels Radio Modem Functionality

The RCQ3-434-RM Radio Modem has applications in many areas where reliable half duplex communications are required over ranges up to 200 meters (with the maximum RF Power is possible to reach up to 400-500meters).

The crystal controlled narrow band design, in the embedded RCQ3-434-RM device, gives reliable performance within the 433 MHz band.

The addressing protocol employed enables many different configurations such including:

**one-to-one operation:** for point to point data communication;

**broadcast operation:** where a single master address many RCQ3-434-RM modules concurrently (using many RCQ3-434 modules set to the same address);

**one-to-many:** a network consisting a master and many slaves (the receivers all have the same address)

**many-to-one:** where the transmitters all send to a single receiver address

Since each RCQ3-434-RM can contain a unique address, multiple RCQ3-434-RM network can co-exist in the same area.

Each Radio Modem (RCQ3-434-RM) is pre-configured with a default address «7E 7E 7E 7E», this address can be modified during the configuration.

When the RCQ3-434-RM receive the data via RF, the first operation that make is the check the address header and compare it with its address, only if the two addresses coincide it processes the data and output them on the serial interface otherwise all the data are discarded.

When the RCQ3-434-RM sending data has a default remote address «7E 7E 7E 7E» this address can be modified during the configuration.

If the addresses are set appropriately, a network can be created.

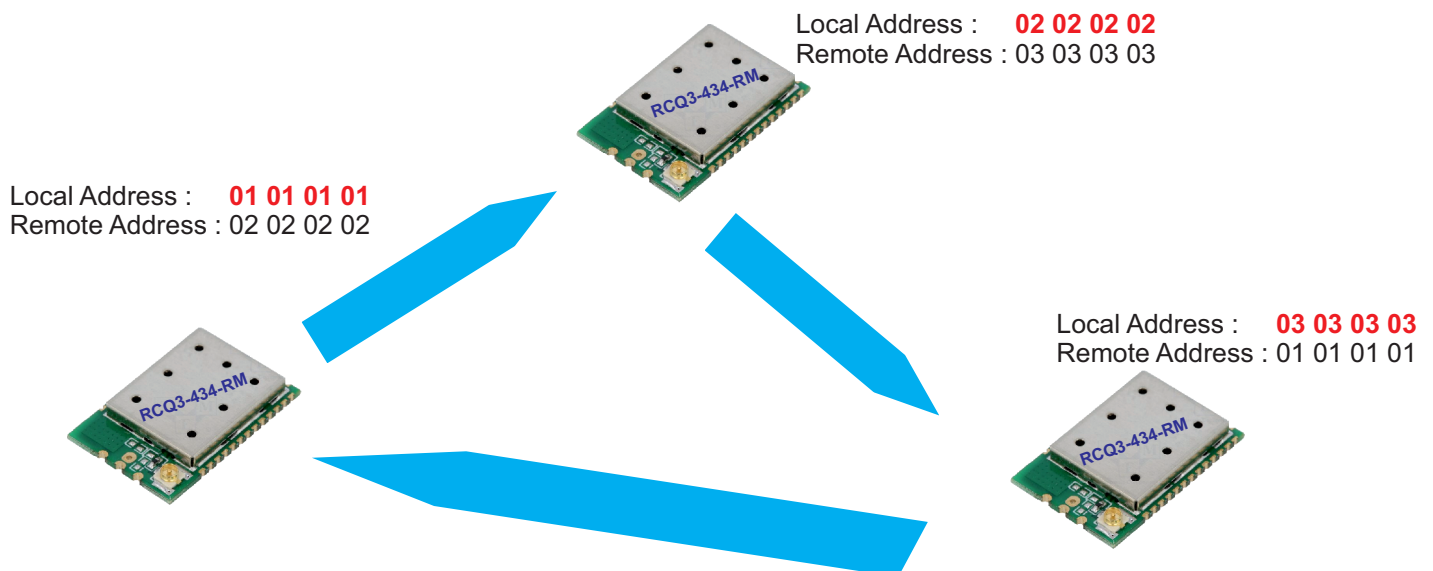

# RCQ3-434-RM

- Multichannels Radio Modem

Frequency band : 430MHz ÷ 435MHz

## 5.0 Long Range Mode Functionality

The Radio Modem RCQ3-434-RM is based on the CC1310 device from Texas Instrument. This device can be work also in Long Range Mode (LRM) that is a particular encoding technique that trades data rate for sensitivity gains. These gains are achieved by digital coding.

For more information you can consult this document : <http://www.ti.com/lit/an/swra642/swra642.pdf>

When aiming at lower sensitivity values, you have the option of reducing the symbol rates transmitted over the air. Reducing the symbol rate normally implies a lower signal bandwidth.

This application can be work in two modality :

Mode	Parameters	Value
STANDARD MODE	Data Rate	50 kbps
	Modulation	2-GFSK
	Deviation	25KHz
	Frequency Channels	Programmable see table sheet 7
	RF Power Output	Programmable see table sheet 7
LONG RANGE MODE	Data Rate	2.5 kbps
	Modulation	2-GFSK
	Deviation	5KHz
	Frequency Channels	Programmable see table sheet 7
	RF Power Output	Programmable see table sheet 7

To operate the device in LRM (Long Range Mode) uses the command ^ L see pages 11.

### STANDARD MODE

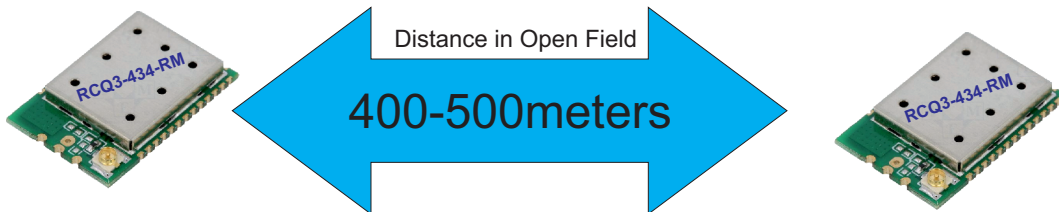

### LONG RANGE MODE

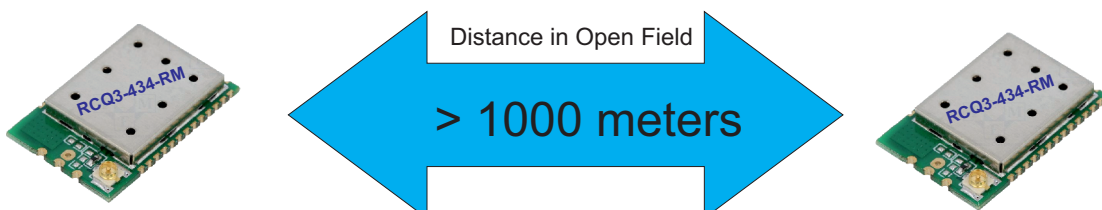

# RCQ3-434-RM

- Multichannels Radio Modem  
Frequency band : 430MHz ÷ 435MHz

## 6.0 Application

### Application Notes

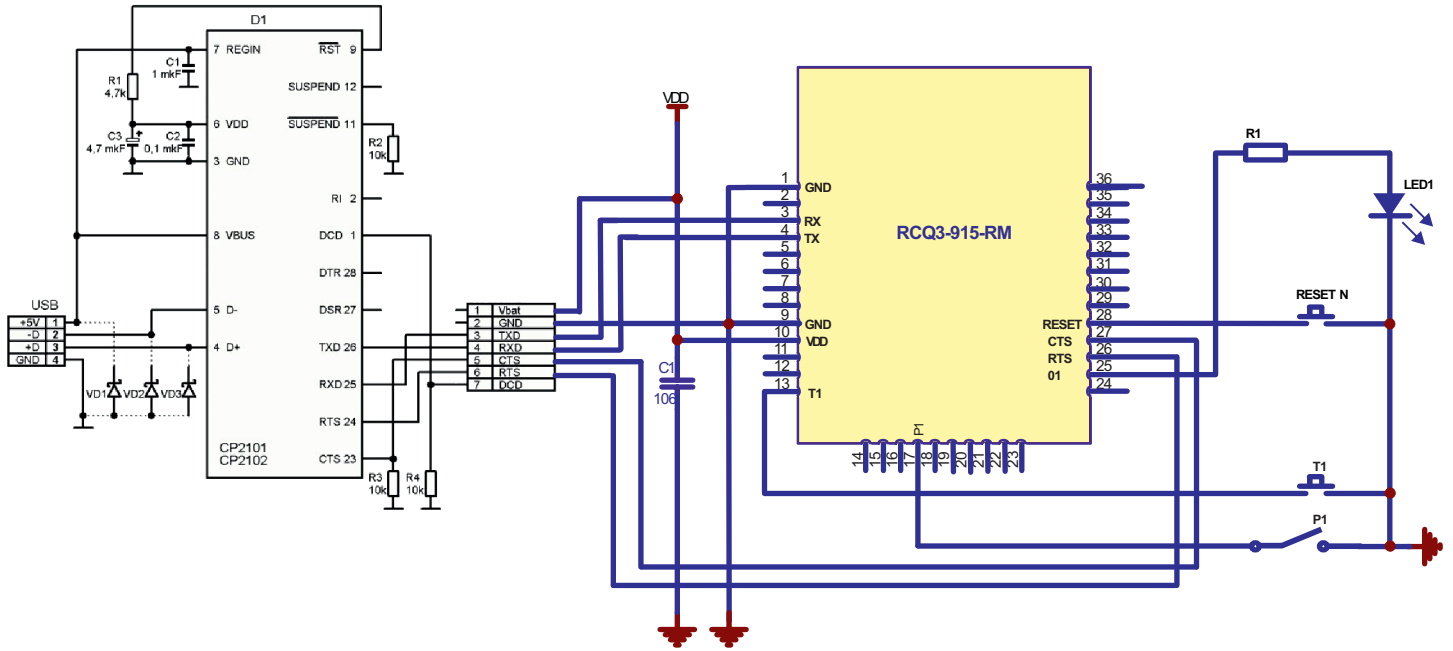

Serial Connection using CP2102 (Silicon Labs) example.

P1 = Switch P1 (pin 17 to GND) to entry in TEST MODE (in TEST MODE the LED1 will light up)

when the device is in TEST MODE you can use Push T1 button (pin 13 to GND) with this operation the carrier with frequency and amplitude value previously set will be present on the antenna.

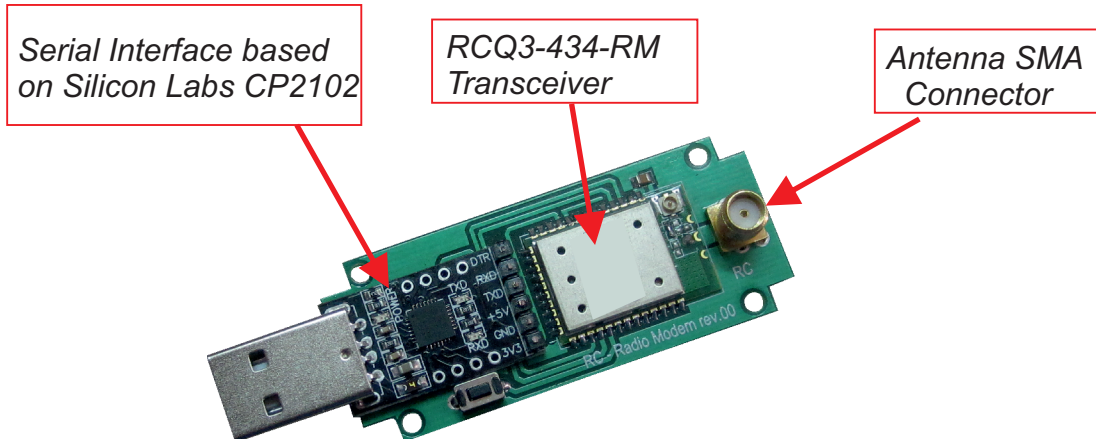

## 7.0 Configuration Mode - Register Value

Register	Byte	Name	Description	Text Value	HEX Value
01	0		MSB	~	7E
	1	Remote Address		~	7E
	2			~	7E
	3		LSB	~	7E
02	4		MSB	~	7E
	5	Local Address		~	7E
	6			~	7E
	7		LSB	~	7E
03	8	RF CHANNELS	430.0MHz	2	32
			430.2MHz	4	34
			430.4MHz	6	36
			430.6MHz	8	38
			430.8MHz	:	3A
			431.0MHz	<	3C
			431.2MHz	>	3E
			431.4MHz	@	40
			431.6MHz	B	42
			431.8MHz	D	44
			432.0MHz	F	46
			432.2MHz	H	48
			432.4MHz	J	4A
			432.6MHz	L	4C
			432.8MHz	N	4E
			433.0MHz	P	50
			433.2MHz	R	52
			433.4MHz	T	54
			433.6MHz	V	56
			433.8MHz	X	58
434.0MHz	Z	5A			
434.2MHz	\	5C			
434.4MHz	^	5E			
434.6MHz	<	60			
434.8MHz	b	62			
435.0MHz	d	64			
04	9	RF TX POWER	0 dBm	0	30
			2 dBm	2	32
			4 dBm	4	34
			6 dBm	6	36
			8 dBm	8	38
			10 dBm	:	3A
			12 dBm	<	3C
			14 dBm	>	3E

### Register 01 - Remote Address

Value Range : 01010101 - FEF EFEFE  
Default Value : 7E7E7E7E

### Register 02 - Remote Address

Value Range : 01010101 - FEF EFEFE  
Default Value : 7E7E7E7E

### Register 03 - RF CHANNELS

Value Range : 32 - 64  
Default Value : 50

The **RF Channel is calculated** in the following mode:

FREQ = 425 + (ASCII code / 10) + (Rest division / 10)  
for example to character «R» (HEX 52) corresponds to the frequency 433.2MHz because :

«R» Ascii Code = 82 ----> Frequency = 425+ int(82/10)

Result + rest division (82/10) = 425+8+0.2 = 433.2

### Register 04 - RF TX POWER

Value Range : 30 - 3E  
Default Value : 3A

The **Power value is calculated** in the following mode:

Power = Ascii code - 48  
For example to the character «7» (HEX 37) correspond the value 7dBm because :  
«7» Ascii code = 55 -----> Power = 55 - 48 = 7

In **RED color** the default parameters

# RCQ3-434-RM

- Multichannels Radio Modem

Frequency band : 430MHz ÷ 435MHz

## 7.1 Example of Configuration

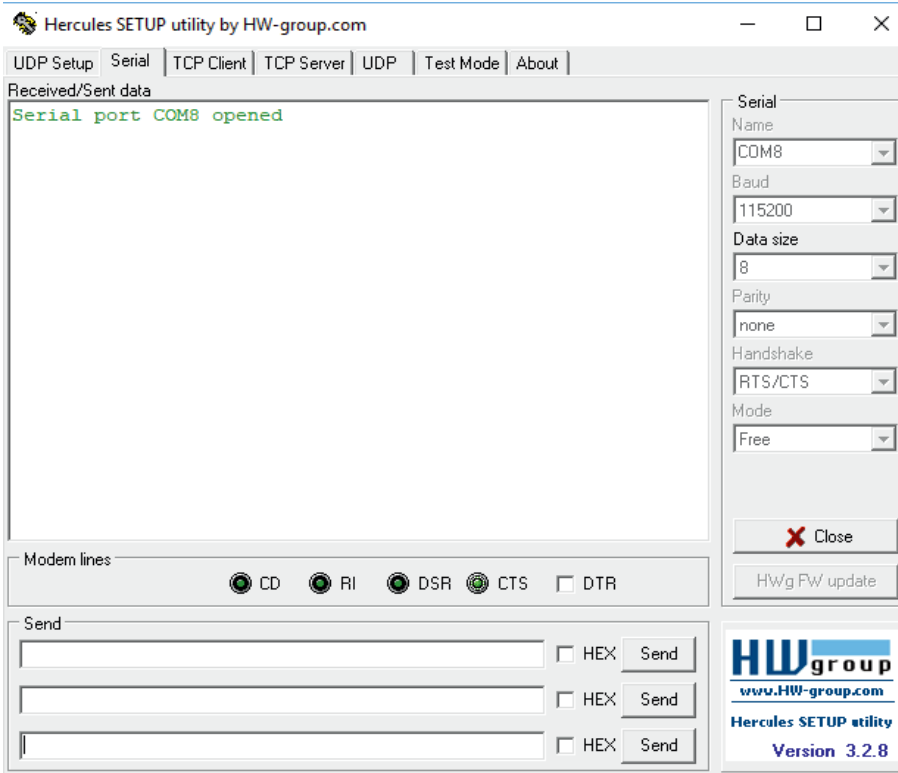

Software used : Hercules SETUP utility (free use)

Open the serial port with this parameters

Set the Hercules software to receive hexadecimal character press the right mouse button and :  
- In the Special Chars menù choise HEX after  
- Choice HEX Enable

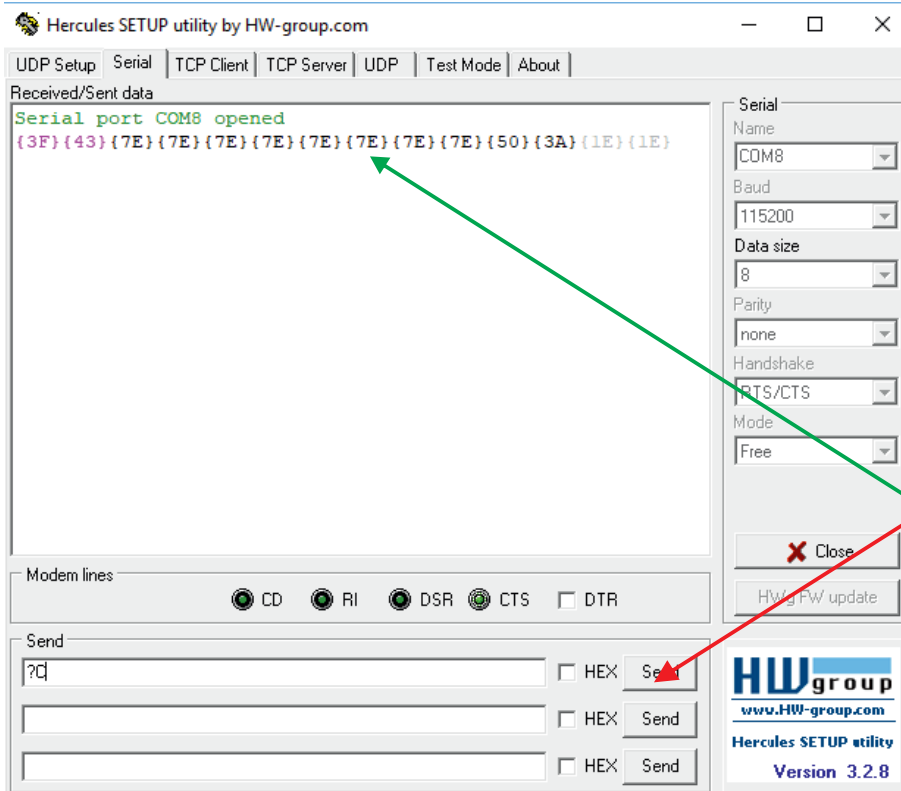
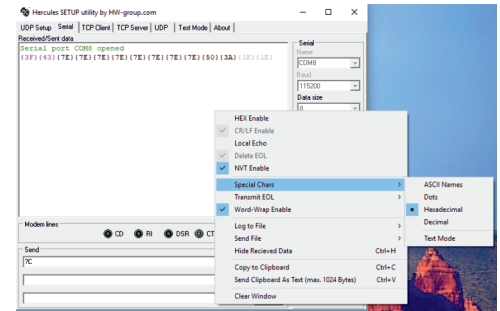

Push this button, in this mode the string "?C" is transmitted (request of configuration)

The module responds by sending the default configuration parameters  
**7E 7E 7E 7E 7E 7E 7E 7E 50 3A**

Remote Address    Local Address    Frequency Channels    RF Power



# RCQ3-434-RM

- Multichannels Radio Modem  
Frequency band : 430MHz ÷ 435MHz

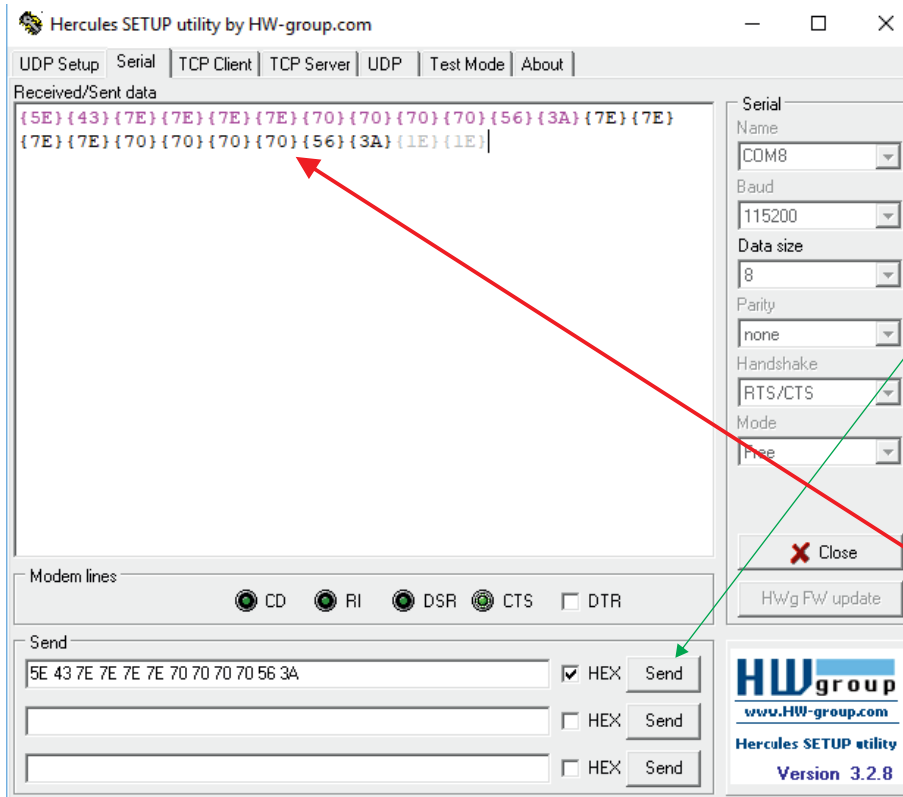

Push this button, in this mode we sent the new Configuration String 7E 7E 7E 7E **70 70 70 70 56 3A** (hexadecimal string)  
We have changed the parameters in red :

- 70 70 70 70** Local address
- 56** Frequency = 433.6MHz

The module answer confirming the new configuration :  
7E 7E 7E 7E **70 70 70 70 56 3A**

These operation can be done also in Text Mode instead that in Hex Mode, in this case the default string is :  
«~~~~~P:» ( 7E 7E 7E 7E 7E 7E 7E 7E 50 3A  
To modify is necessary send the following text string «3C~~~~ppppV:» (53 43 7E 7E 7E 7E 70 70 70 70 56 3A

## 8.0 Example of Operation Mode (One to One)

This example is performed according to the following schematics and using the software Hercules SETUP utility (free use).  
The maximum length of the single packet that can be transmitted is 25byte.

**On Air** 400-500meter in open field STANDARD MODE)  
> 1Km in open field LONG RANGE MODE LRM

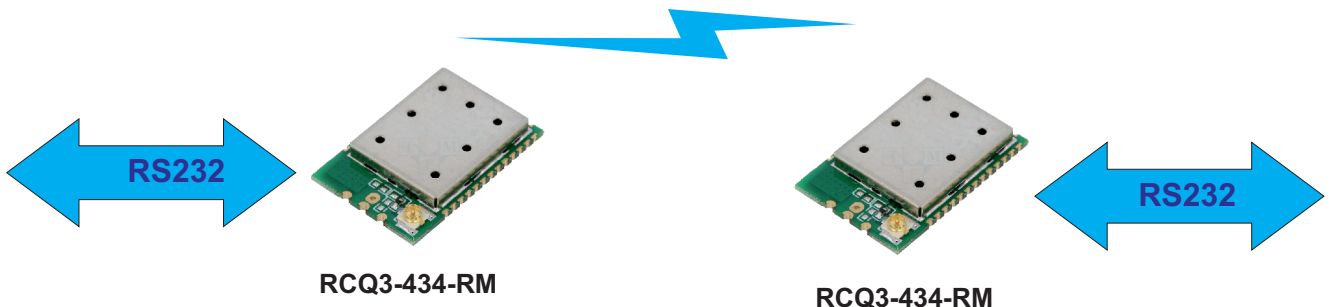

# RCQ3-434-RM

- Multichannels Radio Modem

Frequency band : 430MHz ÷ 435MHz

Serial Port COM8

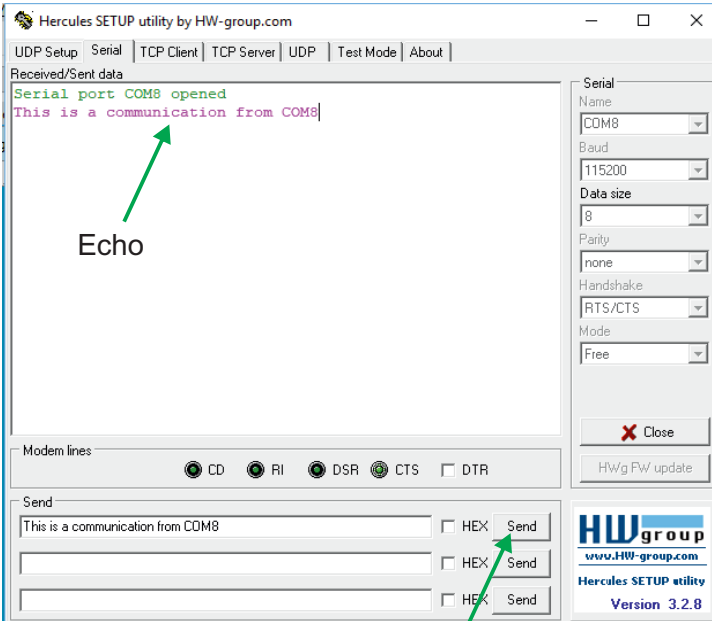

Serial Port COM10

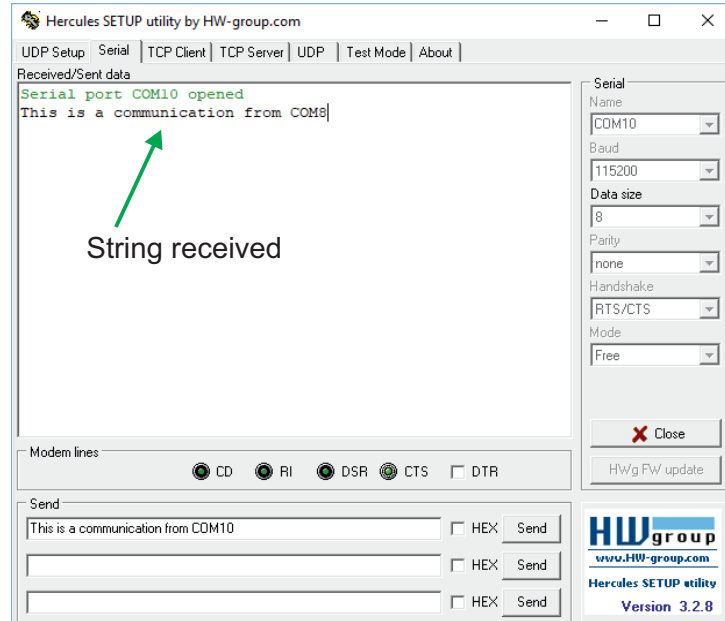

Push this button, in this mode we sent the following string "This is a communication from COM8"

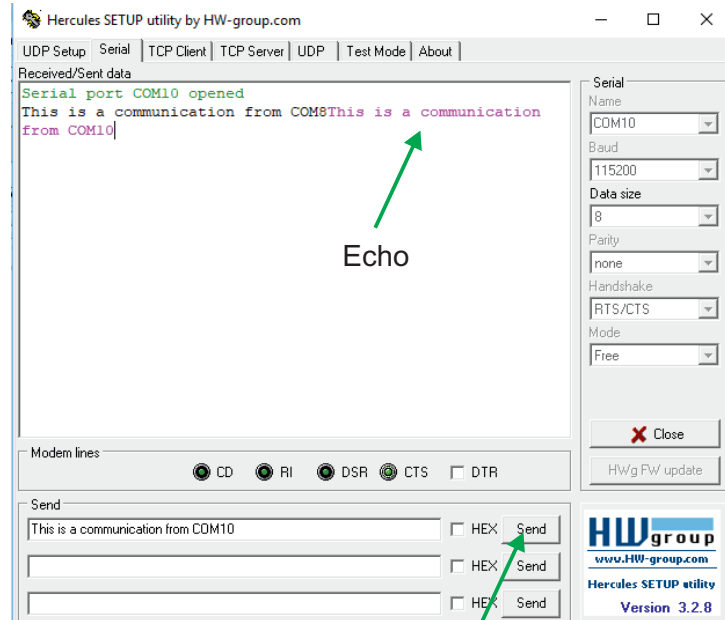
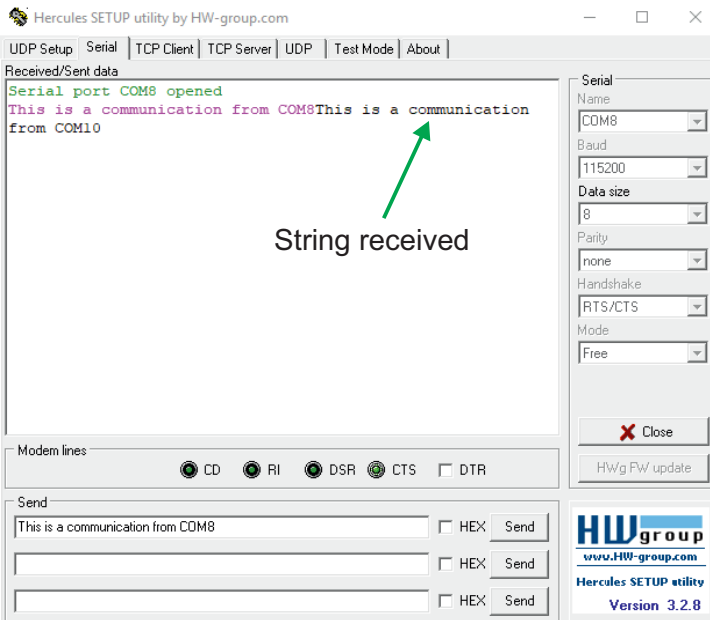

Push this button, in this mode we sent the following string "This is a communication from COM10"

## 9.0 Local List Command

Local Command	Description	Example
1 ?C	Returns the configuration parameters : 1) Remote Address, 2) Local Address, 3) Frequency, 4) Power Value	See par. 9.1
2 ?T	Returns the temperature value (°C)	See par. 9.2
3 ?B	Returns the value of battery (Volt)	See par. 9.2
4 ?V	Returns the FW version	See par. 9.3
5 ?BR	Returns the baud rate setted	See par. 9.3
6 ?S	Returns the general information	See par. 9.4
7 ^C+CONF	Allows to modify the configuration of the module example : ^C~~~~~T2 (text) or 53 43 7E 7E 7E 7E 7E 7E 54 32 (Hex)	See par. 9.5
8 ^B+BAUDRATE	Value accepted : 115200,57600,38400,19200,9600,4800,2400,1200 Example : ^B115200 . After this command you must reset the device.	See par. 9.6
9 ^L1	The device go in Long Range Mode LRM	See par. 9.7
10 ^L0	The device go in Standard Mode	See par. 9.7

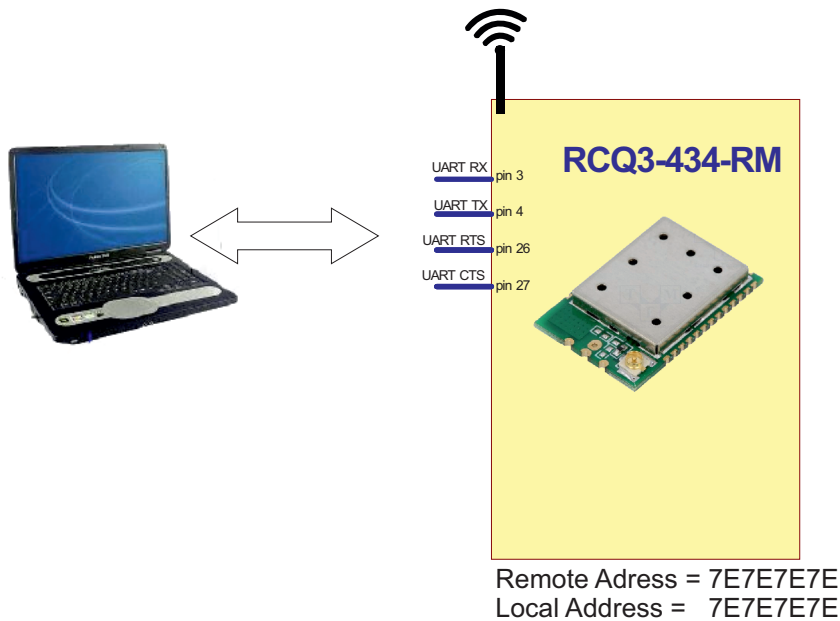

## 9.1 «?C» Command

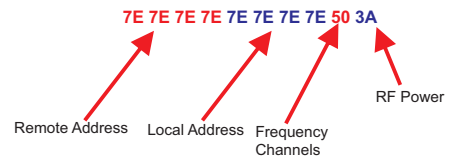
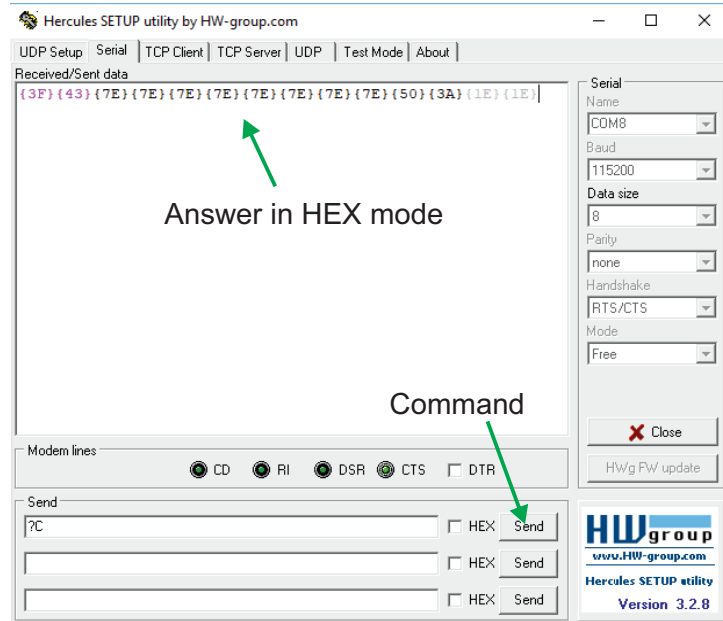
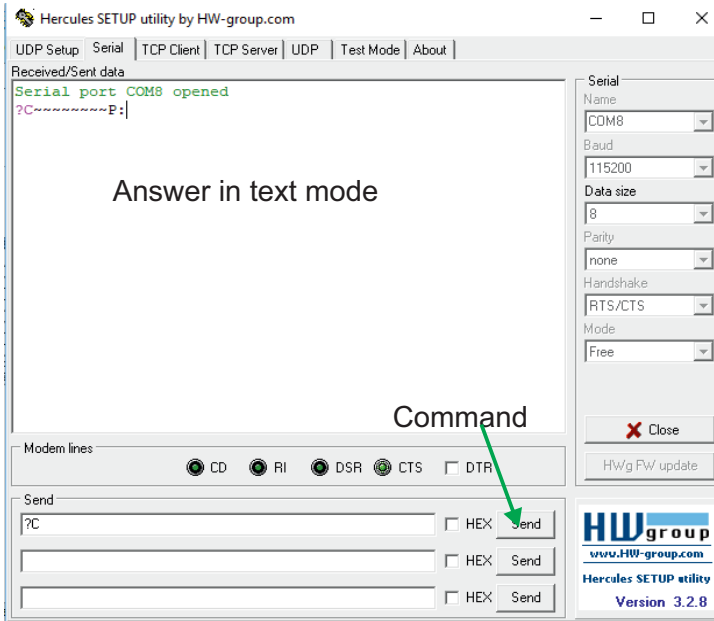

## 9.2 «?T» and «?B» Command

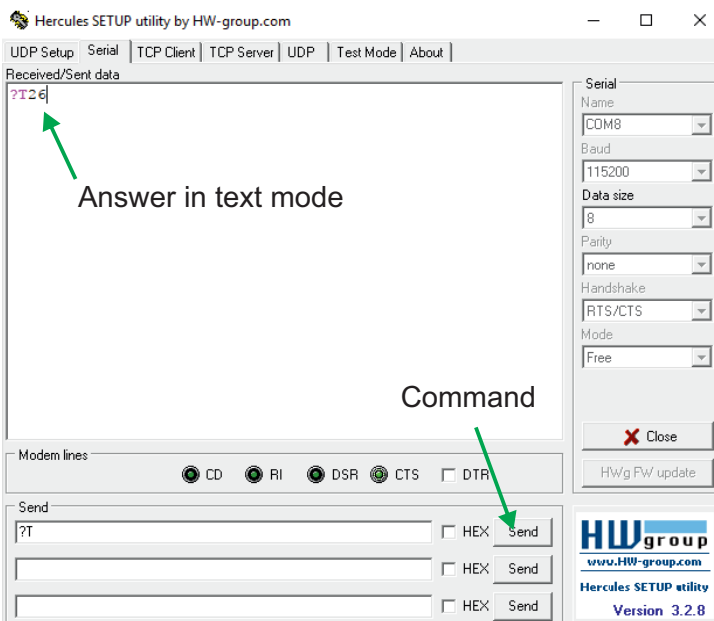

Return the value in °C.

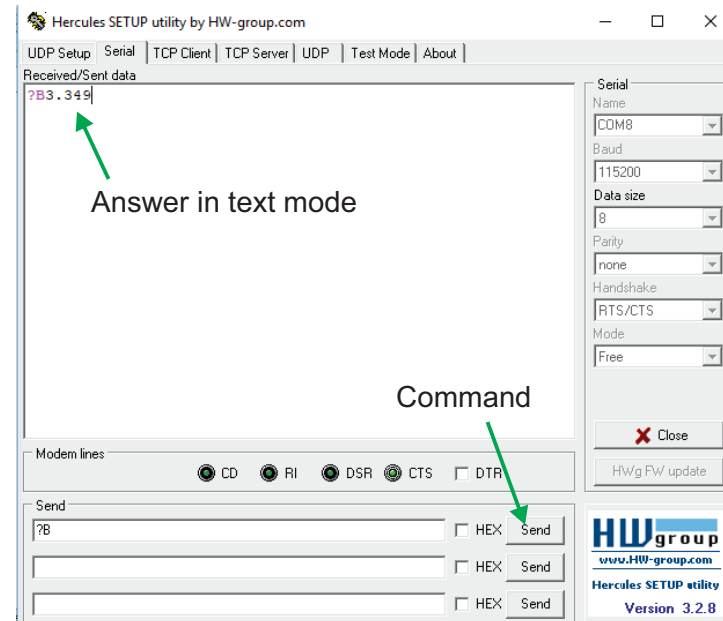

Return the value in Volt.

## 9.3 «^V» and «?BR» Command

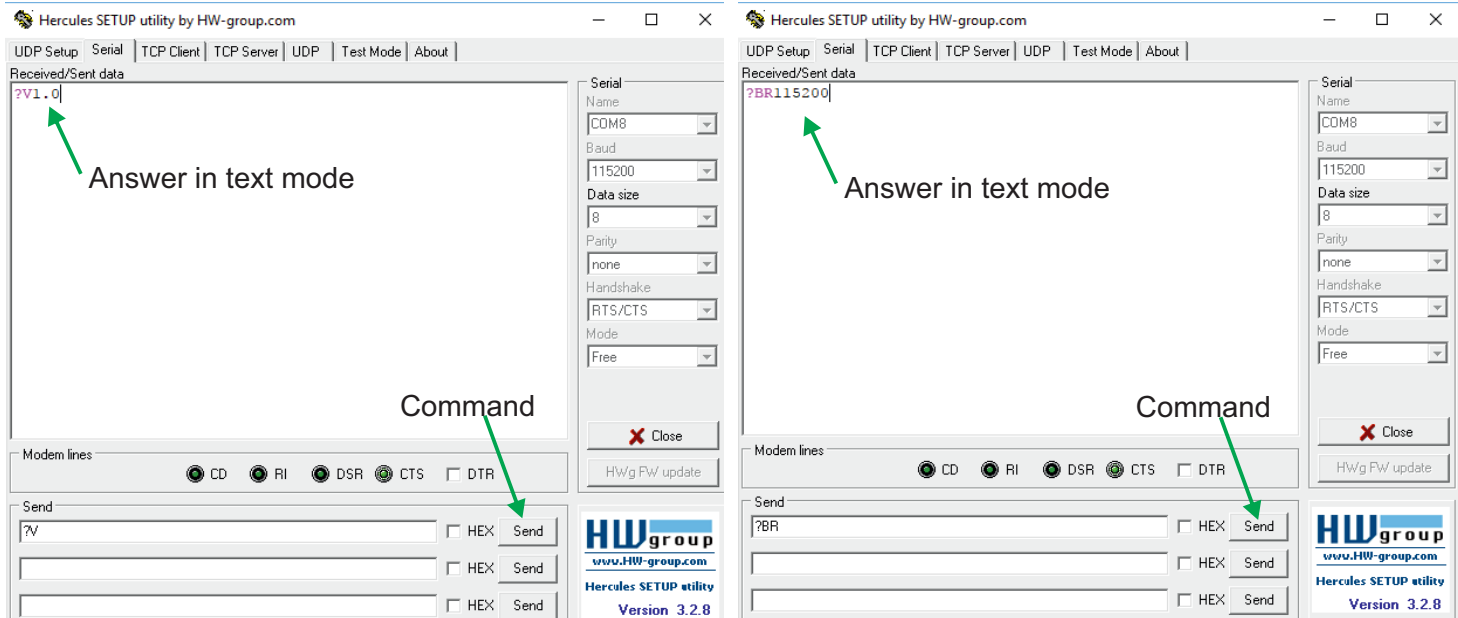

Firmware version

Baud rate

## 9.4 «?S» Command

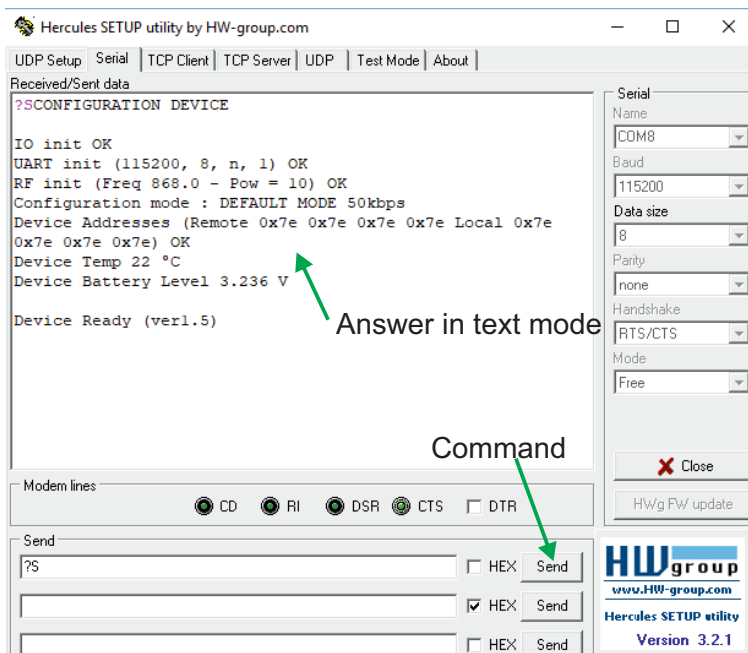

General information

## 9.5 «^C+ Configuration»

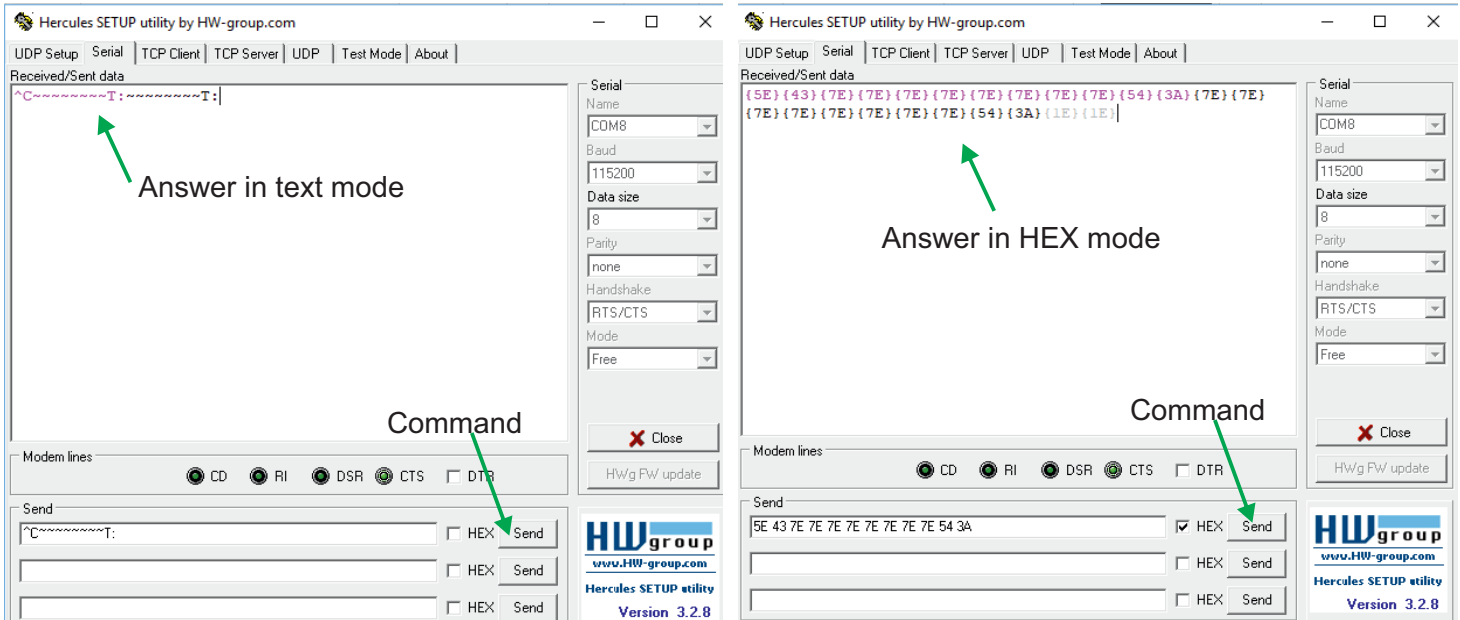

Example of configuration in text mode and in Hex Mode

## 9.6 «^B+ Baudrate»

Il device initially is configured at 38400 baud rate

Open device at 115200 baud rate  
Send the command ?S and you can verify the configuration.

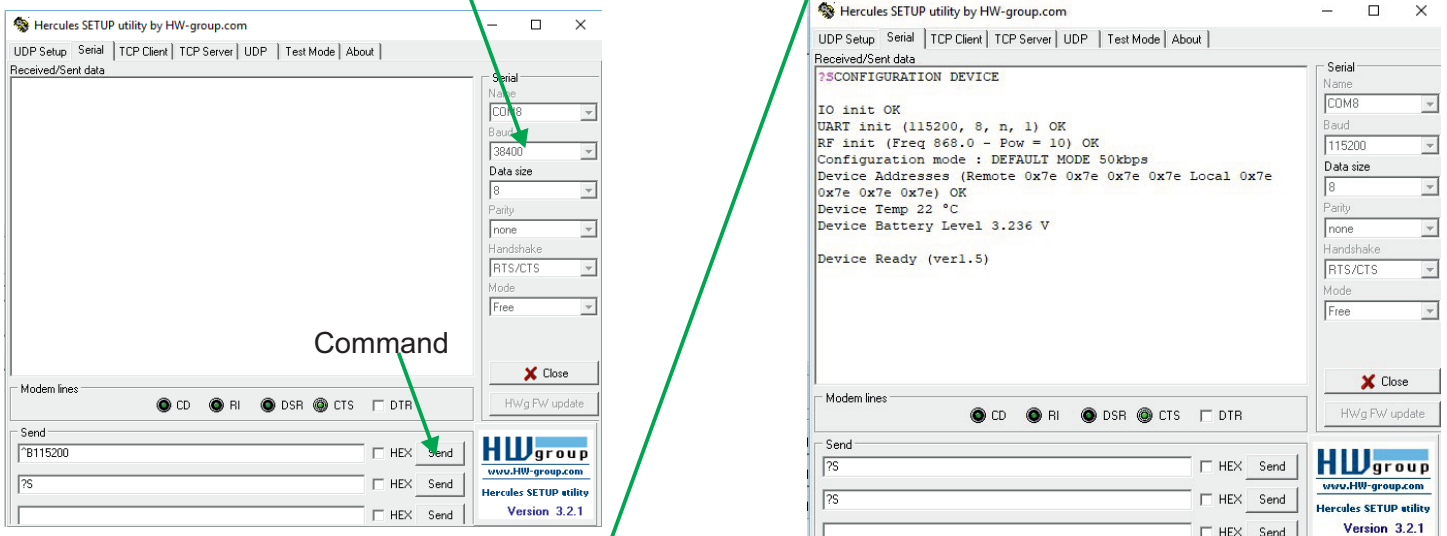

After the command ^B115200 is necessary to make an hardware RESET.

## 9.7 «^L1 Long Range Mode or Standard Mode»

With the command L1 the device go in Long Range Mode.

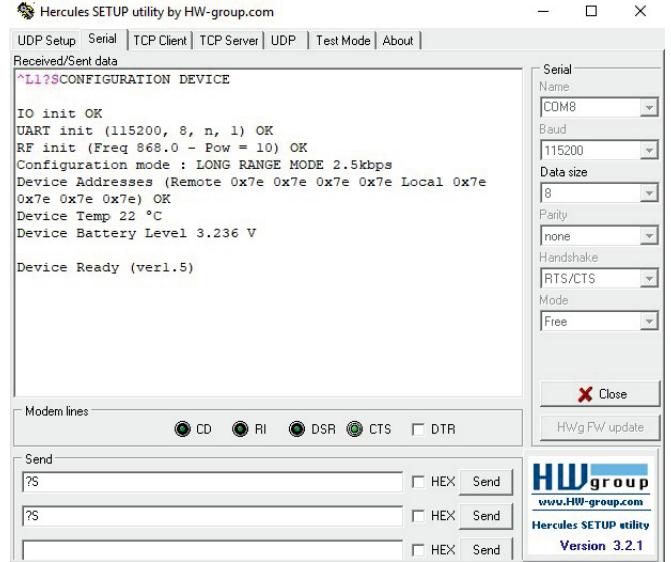
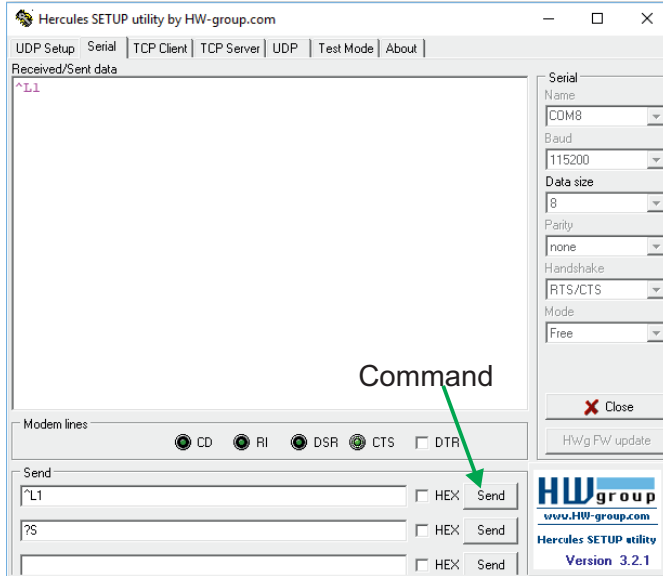

?S to verify the configuration of the device

With the command L0 the device go in Standard Mode.

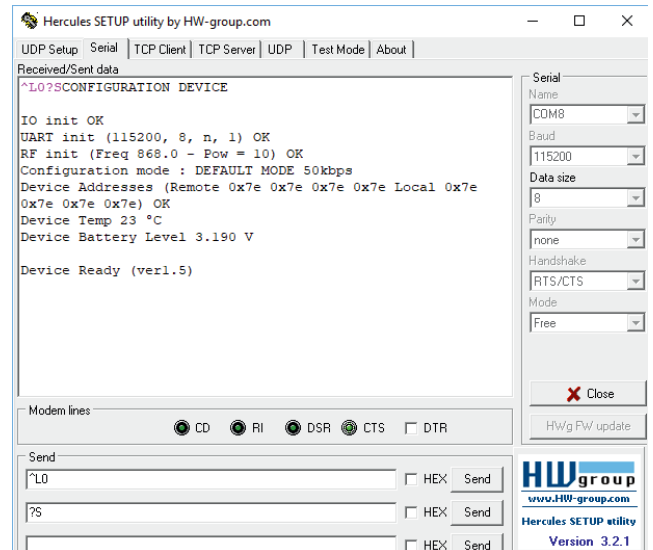
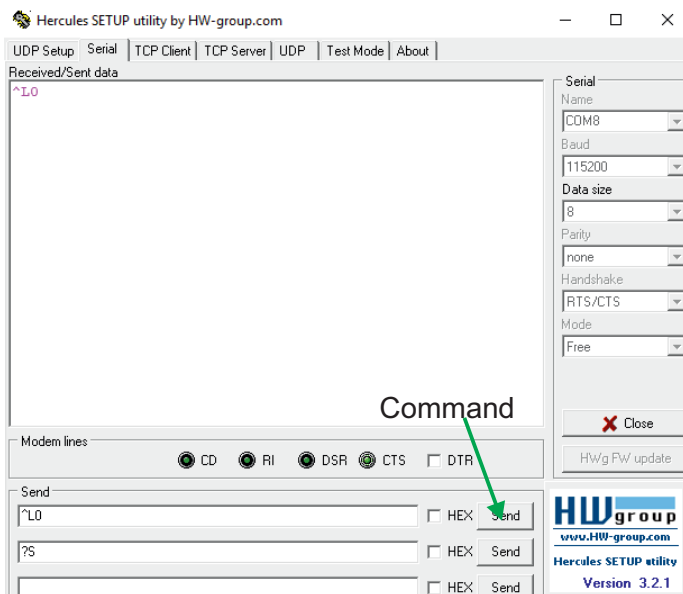

?S to verify the configuration of the device

## 10.0 Remote List Command

	Remote Command	Description	Example
1	<b>##?C</b>	Returns the configuration parameters : 1) Remote Address, 2) Local Address, 3) Frequency, 4) Power Value	See par. 9.1
2	<b>##?T</b>	Returns the temperature value (°C)	See par. 9.2
3	<b>##?B</b>	Returns the value of battery (Volt)	See par. 9.2
4	<b>##?V</b>	Returns the FW version	See par. 9.3
5	<b>##?RS</b>	Returns the RSSI value	See par. 9.4
6	<b>##^C+Configuration</b>	Allows to modify the configuration of the module example : ^C~~~~~T2 (text) or 53 43 7E 7E 7E 7E 7E 7E 7E 54 32 (Hex)	See par. 9.5

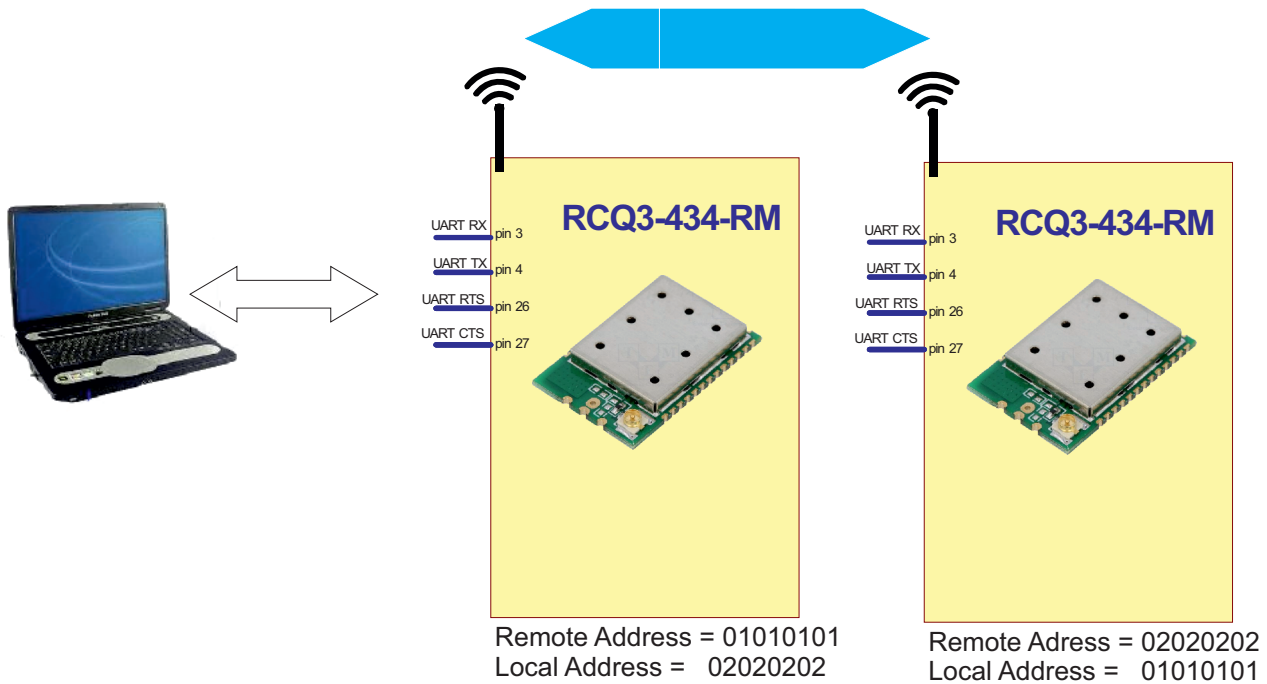



## 10.1 «##?C» Command

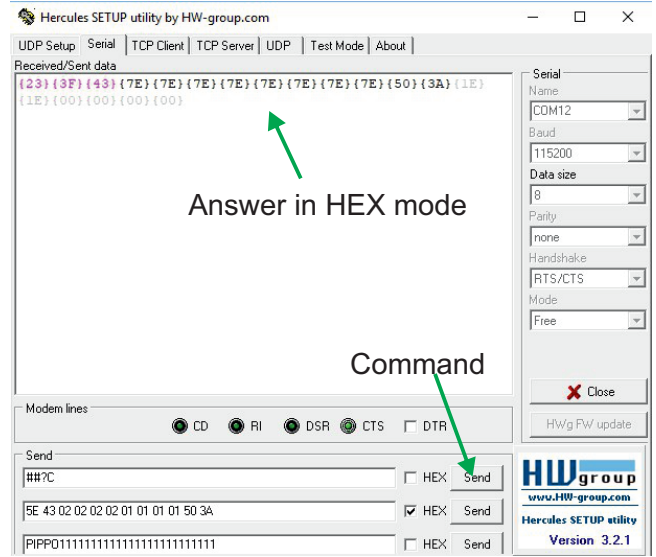
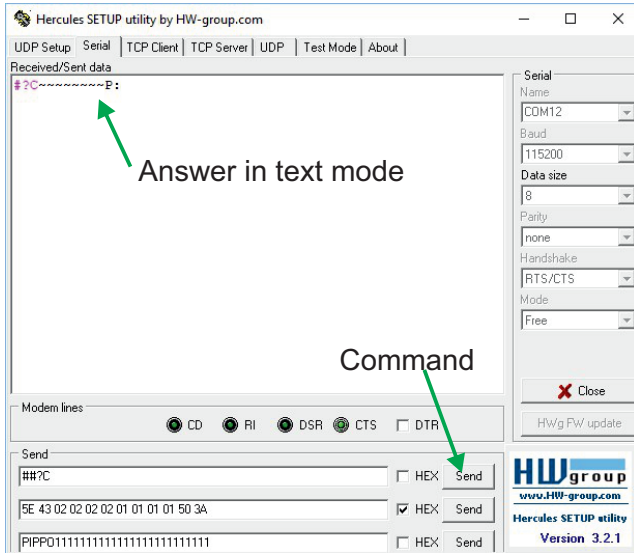

## 10.2 «##?T» and «?B» Command

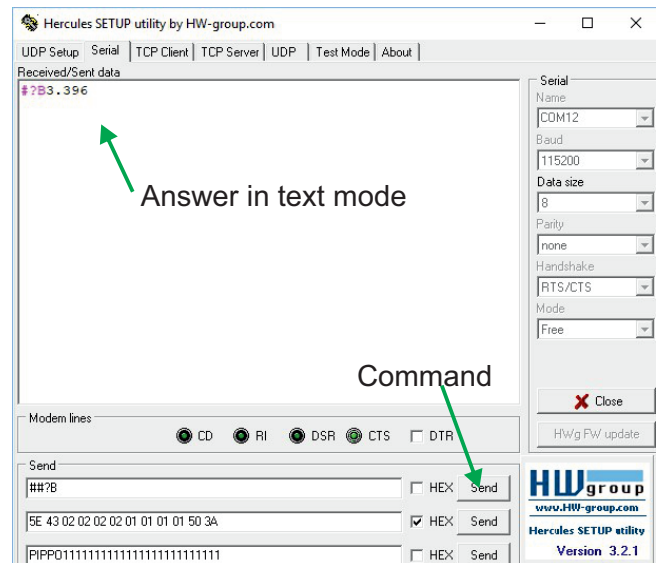
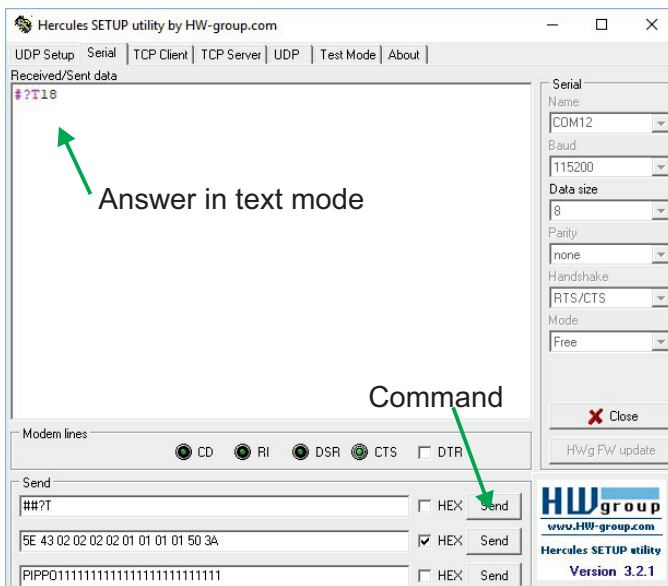

## 10.3 «##^V» Command

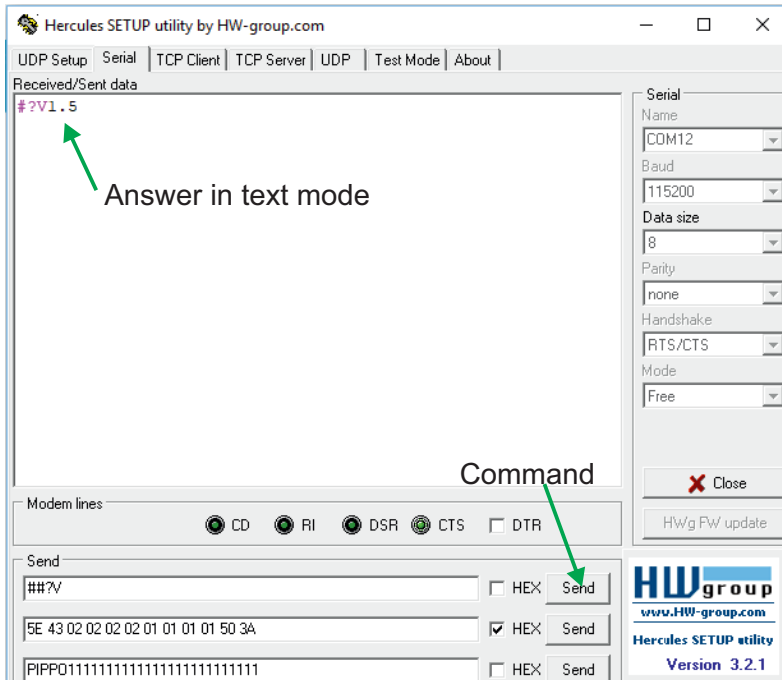

## 10.4 «##RS» Command

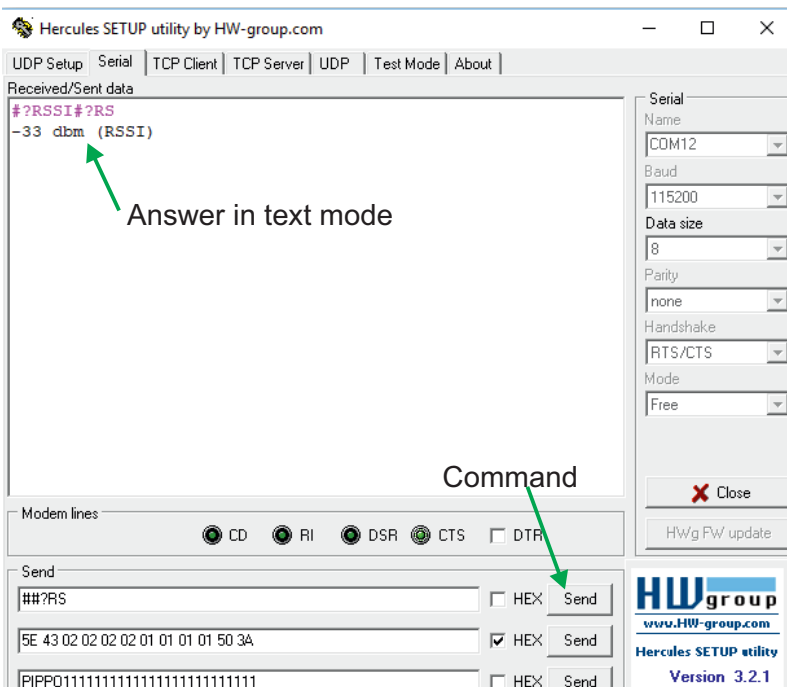

## 10.5 «##^C + Configuration» Command

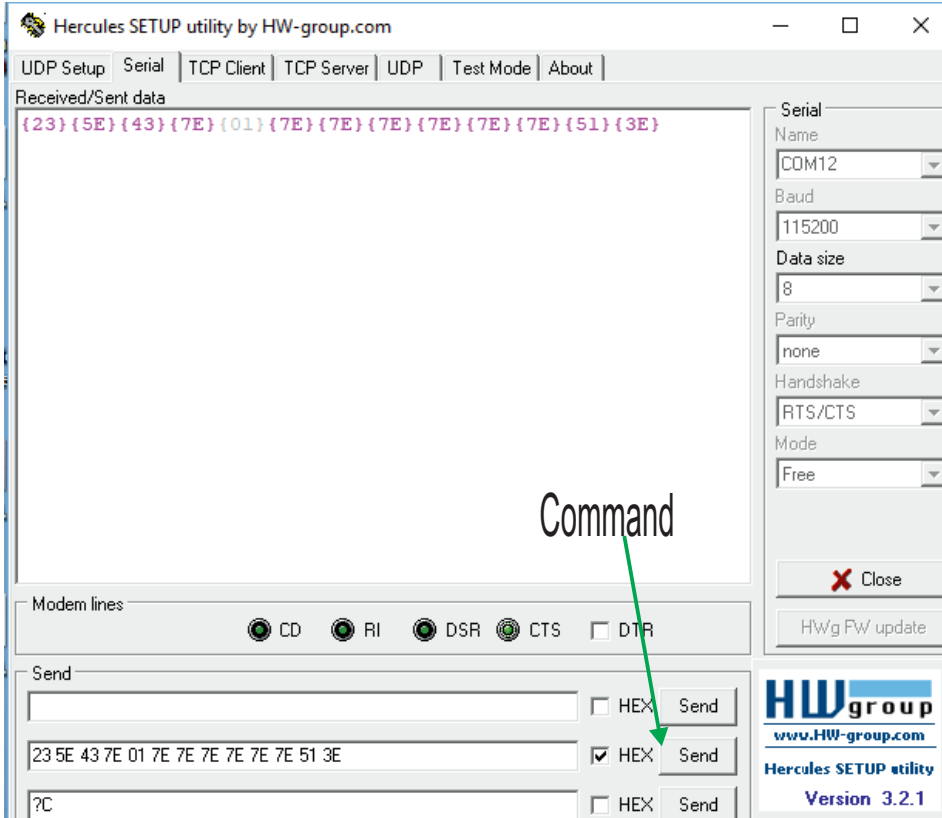

# RCQ3-434-RM

- Multichannels Radio Modem  
Frequency band : 430MHz ÷ 435MHz

## 11.0 Evaluation board RCQ3-434-DK

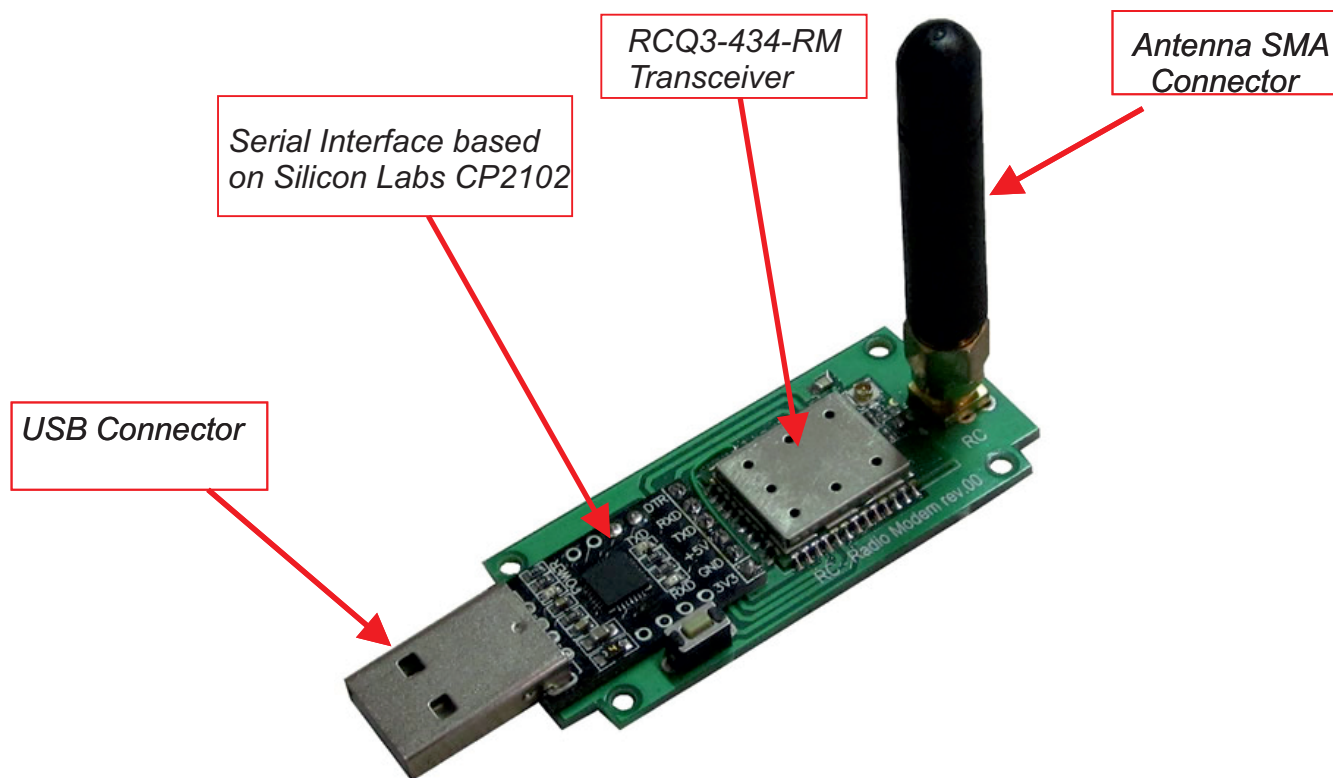

- The Evaluation board is explained on the picture above it is complete with Antenna 433MHz .

- It's necessary install the CP2102 driver on your computer, you can find this driver or on Silicon Labs website.

## X-ON Electronics

Largest Supplier of Electrical and Electronic Components

*Click to view similar products for [RF Modules](#) category:*

*Click to view products by [Radiocontrolli](#) manufacturer:*

Other Similar products are found below :

[HMC-C009](#) [HMC-C011](#) [nRF24L01P-MODULE-PCB](#) [HMC-C021](#) [HMC-C024](#) [XB9XT-DPRS-721](#) [XBP9B-DMUTB022](#) [nRF24L01P-MODULE-SMA](#) [CMD-KEY2-418-CRE](#) [XM-C92-2P-UA](#) [XB9XT-DPUS-721](#) [V640-A90](#) [HMC-C583](#) [MAAM-008818-TR3000](#) [MTSMC-H5-U](#) [SIMSA868-PRO](#) [SIMSA915C-PRO](#) [SIMSA868C-PRO](#) [SIMSA433C-PRO](#) [SIMSA915-PRO](#) [XBP9B-DMUT-042](#) [HMC-C582](#) [HMC-C022](#) [XBP9B-DPST-041](#) [XBP9B-DMWT-042](#) [SM-MN-00-HF-RC](#) [HMC-C031](#) [MT-02](#) [M1002GB](#) [702-W](#) [SIMSA868C-N-PRO](#) [SIMSA433C-N-PRO](#) [SIMSA915C-N-PRO](#) [ADP-R202-00B](#) [PEPPER WIRELESS C1 USB](#) [S2-10732-Z1T61](#) [S2-107XB-Z2356-Z2352](#) [S2-10672-Z1L85](#) [S2-10686-Z1L1D](#) [S2-10688-Z1L1T](#) [S2-106BA-Z1P20](#) [S2-1060C-Z1F0A](#) [S2-106R4-Z1Q6F-Z1Q6Q](#) [S2-106R4-Z1Q6J-Z1Q6Q](#) [S2-106RB-Z1Q6V-Z1Q6Q](#) [S2-107DR-Z1Y5B](#) [SU60-2230C-PU](#) [RC-TFSK3-868](#) [NANO RFID POE](#) [650201424G](#)