

CIRCUIT BOARD SUPPORTS — SNAP-IN — LOCKING

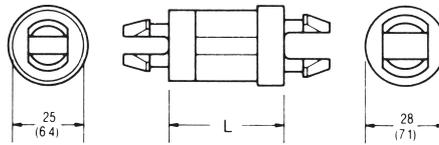

Part No.	Dimension L	
	Inches	(mm)
30161	3/16	(4.8)
30162	1/4	(6.4)
30163	3/8	(9.5)
30164	1/2	(12.7)
30165	5/8	(15.9)
30166	3/4	(19.1)
30167	7/8	(22.2)
30168	1	(25.4)

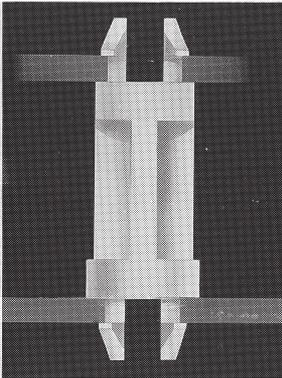
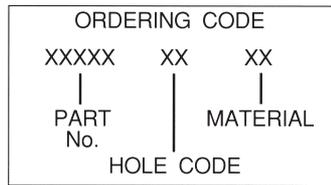

BOARD/CHASSIS HOLE CODE		
BOARD HOLE DIA	CHASSIS HOLE DIA	CODE
.156 (4.0)	.156 (4.0)	5
.187 (4.8)	.187 (4.8)	9
.156 (4.0)	.187 (4.8)	59

- Fits 1/16" (1.6) nominal thick board
- Large base on one side differentiates one end from the other
- .10" (2.5 mm) maximum protrusion past panel
- See Engineering data page 184

MATERIAL	CODE	RoHS
Nylon	N	YES

CIRCUIT BOARD SUPPORTS — LOCKING — MINIATURE

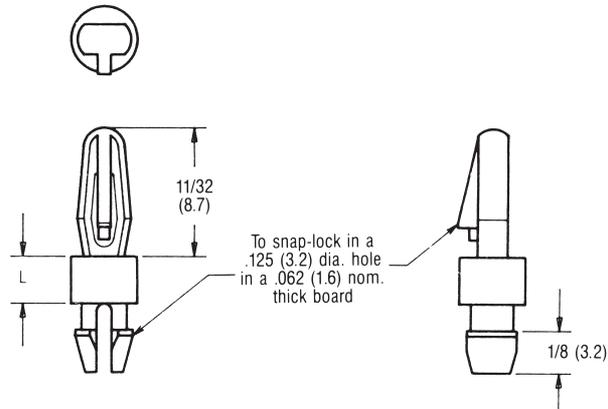
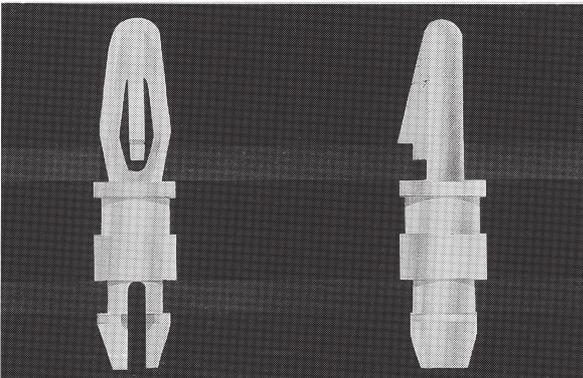

Part No.	Dimension L	
	Inches	(mm)
30170	1/8	(3.2)
30171	3/16	(4.8)
30172	1/4	(6.4)
30173	5/16	(7.9)
30174	3/8	(9.5)
30175	1/2	(12.7)
30176	5/8	(15.9)
30177	3/4	(19.1)
30178	7/8	(22.2)

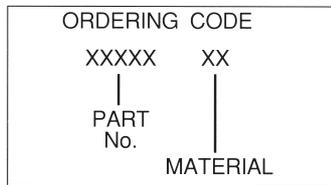

MATERIAL	CODE	RoHS
Nylon	N	YES

- Board mount end releases by hand
- Chassis mount end requires only 1/8" (3.2) clearance
- See Engineering data page 184

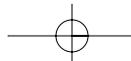

X-ON Electronics

Largest Supplier of Electrical and Electronic Components

Click to view similar products for [Standoffs & Spacers](#) category:

Click to view products by [RAF Electronic Hardware](#) manufacturer:

Other Similar products are found below :

[588-6208-02](#) [599-9844-02](#) [M0516-3-N](#) [M0518-3-N](#) [M0521-3-N](#) [M0524-3-N](#) [M0532-35-N](#) [M0543-4-AL](#) [M0544-35-N](#) [M0544-3-N](#) [M0545-3-AL](#) [M0553-3-N](#) [M0608-5-SS](#) [M0609-5-SS](#) [M0651-5-SS](#) [M0653-35-N](#) [M0654-4-SS](#) [M0655-5-AL](#) [M0658-35-AL](#) [M0660-4-AL](#) [M0670-35-N](#) [M0671-5-N](#) [M0671-5-SS](#) [M0722-5-N](#) [M0725-6-N](#) [M0904-B-25-AL](#) [M1273-2545-AL](#) [M1273-2545-SS](#) [M1273-3005-AL](#) [M1273-3005-SS](#) [M1274-3005-AL](#) [60187](#) [60202-SP](#) [60273](#) [60335-SP](#) [60348-SP](#) [60419-SP](#) [60425-SP](#) [60473-SP](#) [60475-SP](#) [60477-SP](#) [60489-SP](#) [60491-SP](#) [60585-SP](#) [60762-SP](#) [60763-SP](#) [60872-SP](#) [M1303-3506-AL](#) [M1307-3506-AL](#) [M1314-3005-AL](#)