

REV	CHANGE	DATE	DRN	CHK
	Drawn	02/23/17	SJ	T

TOLERANCE DETAILS		
1	A	+0.020 [+0.50] -0.000 [-0.00]
2	B	±0.015 [±0.40]
3	C	±0.015 [±0.40]
4	D	±0.010 [±0.30]

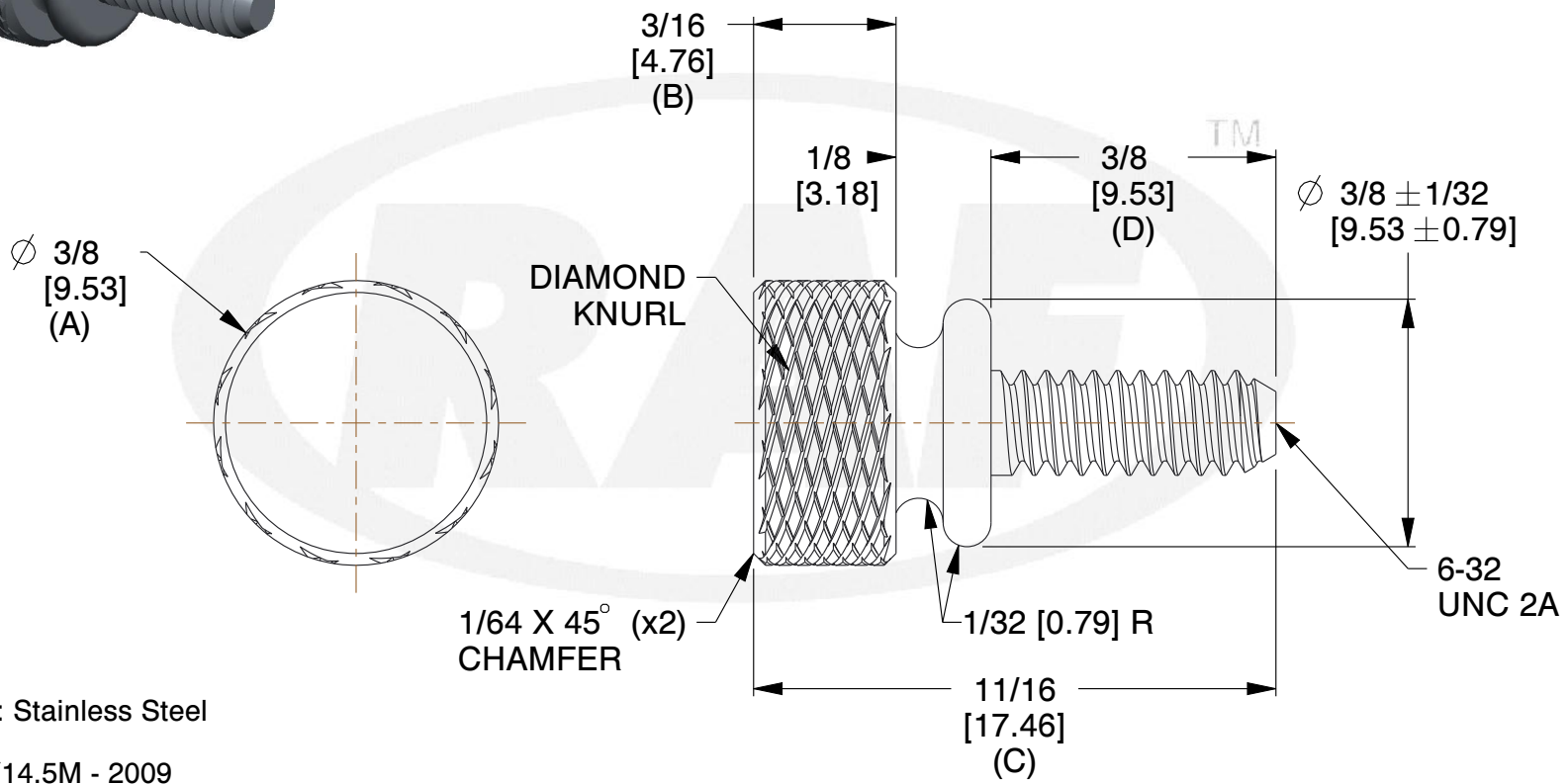
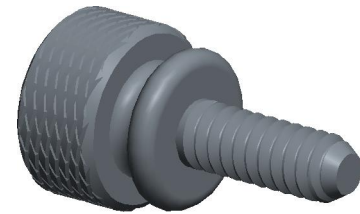

**NOTES:**

1. Material : Stainless Steel
2. Finish :
3. ASME Y14.5M - 2009
4. All Drawing Dimensions are in Inches [mm]
5. Unless otherwise specified; Edge Breaks, Radii or Countersinks 0.005-0.015



95 Silvermine Rd., Seymour CT 06483  
Tel: 203-888-2133, Fax: 203-888-9860

This Drawing is the Property of RAF. It contains confidential, proprietary information that is RAF property. Do not disclose to or duplicate for others except as authorized by RAF.

**TOLERANCES**  
ALL DIMENSIONS ARE INCHES (UNLESS OTHERWISE SPECIFIED)  
**METALLIC**  
LENGTHS < 6 INCHES ± 0.005  
LENGTH > 6 INCHES ± 0.010  
DIAMETERS: ± 0.005  
**NON-METALLIC**  
LENGTH: ± 0.010 DIAMETERS: ± 0.010  
**INTERNAL THREADS:**  
MINIMUM THREAD DEPTH

COMPONENT	THUMB SCREWS
7103-SS	<b>SCALE</b> 4.00
WASHER FACE THUMB SCREWS	<b>SHEET</b> 1 of 1

## X-ON Electronics

Largest Supplier of Electrical and Electronic Components

*Click to view similar products for [Screws & Fasteners](#) category:*

*Click to view products by [RAF Electronic Hardware](#) manufacturer:*

Other Similar products are found below :

[5721-1440-1/4-SS](#) [593503FX](#) [0098.0094](#) [0098.9206](#) [0098.9219](#) [0098.9262](#) [596-2114-013](#) [59781-6](#) [0098.0026](#) [0098.9210](#) [0098.9212](#) [60227-01](#) [60227-04](#) [60227-08](#) [60687-01](#) [LOCK WASHER Black](#) [62153-11](#) [M316-KSSTMCZ100](#) [M3440-SS](#) [M3442-SS](#) [M3448-SS](#) [6292-1](#) [6-306105-9](#) [6-306131-4](#) [690432-1](#) [699161-000](#) [7230-3](#) [7244](#) [7248-1](#) [7248-2](#) [745564-1](#) [F1209](#) [751-00001](#) [7680](#) [809704-1](#) [8700](#) [8860220](#) [9047](#) [9521](#) [992326-6](#) [992763-3](#) [1-18024-0](#) [1-18028-2](#) [A168P1](#) [A495P1](#) [1-24921-1](#) [125416-1](#) [1260](#) [13-0036](#) [1301810148](#) [1301810313](#)