

REV	CHANGE	DATE	DRN	CHK
	Drawn	02/28/17	SJ	T

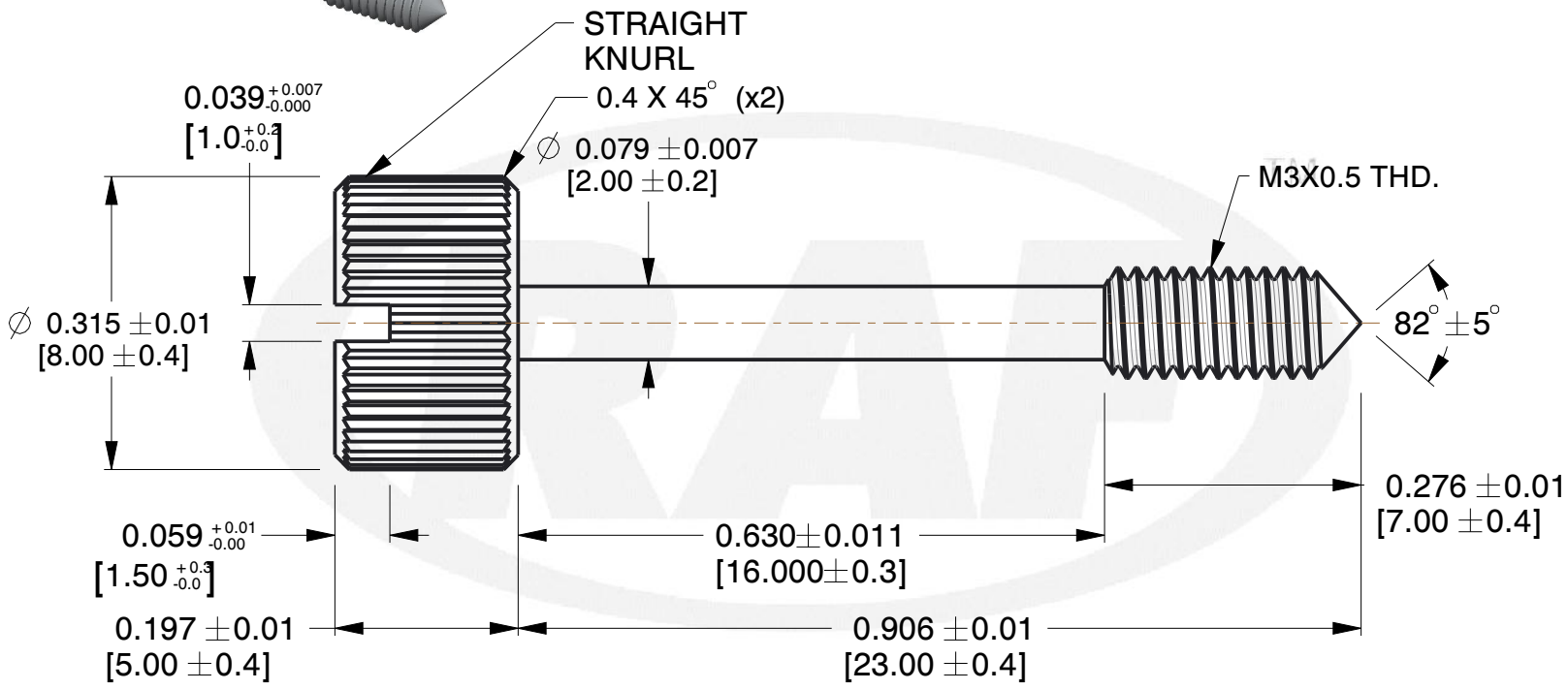
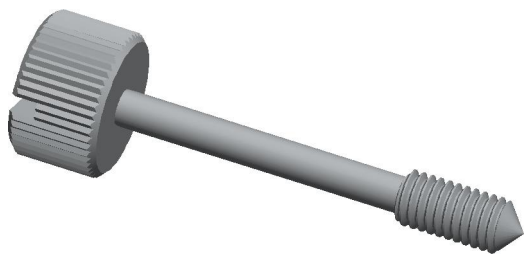

NOTES:

1. Material : Stainless Steel
2. Finish :
3. ASME Y14.5-M - 2009
4. All Drawing Dimensions are in Inches [mm]
5. Unless otherwise specified; Edge Breaks, Radii or Countersinks 0.005-0.015

COMPONENT	PANEL SCREW
M0104-SS	SCALE
CAPTIVE PANEL SCREW STYLE 1	5.00
	SHEET
	1 of 1



95 Silvermine Rd., Seymour CT 06483
Tel: 203-888-2133, Fax: 203-888-9860

This Drawing is the Property of RAF.
It contains confidential, proprietary information that is RAF property. Do not disclose to or duplicate for others except as authorized by RAF.

TOLERANCES
ALL DIMENSIONS ARE INCHES (UNLESS OTHERWISE SPECIFIED)
METALLIC
LENGTHS < 6 INCHES ± 0.005
LENGTH > 6 INCHES ± 0.010
DIAMETERS: ± 0.005
NON-METALLIC
LENGTH: ± 0.010 DIAMETERS: ± 0.010
INTERNAL THREADS:
MINIMUM THREAD DEPTH

X-ON Electronics

Largest Supplier of Electrical and Electronic Components

Click to view similar products for [Screws & Fasteners](#) category:

Click to view products by [RAF Electronic Hardware](#) manufacturer:

Other Similar products are found below :

[5721-1440-1/4-SS](#) [593503FX](#) [0098.0094](#) [0098.9206](#) [0098.9219](#) [0098.9262](#) [596-2114-013](#) [59781-6](#) [0098.0026](#) [0098.9210](#) [0098.9212](#) [60227-01](#) [60227-04](#) [60227-08](#) [60687-01](#) [LOCK WASHER Black](#) [62153-11](#) [M316-KSSTMCZ100](#) [M3440-SS](#) [M3442-SS](#) [M3448-SS](#) [6292-1](#) [6-306105-9](#) [6-306131-4](#) [690432-1](#) [699161-000](#) [7230-3](#) [7244](#) [7248-1](#) [7248-2](#) [745564-1](#) [F1209](#) [751-00001](#) [7680](#) [809704-1](#) [8700](#) [8860220](#) [9047](#) [9521](#) [992326-6](#) [992763-3](#) [1-18024-0](#) [1-18028-2](#) [A168P1](#) [A495P1](#) [1-24921-1](#) [125416-1](#) [1260](#) [13-0036](#) [1301810148](#) [1301810313](#)