

**LUMOTAST 75 IP65 - Illuminated pushbutton, flush lens,
square collar, 2 NC + 2 NO, latching, housing
1.15.108.377/0000**



General information

Form of lens	flat
Form of collar	square
Color of collar	black

Dimensions

Length of collar	19 mm
Width of collar	19 mm
Overall height	10.5 mm
Mounting depth	49.5 mm
Mounting hole	16.2 mm

Mechanical design

Mounting	ring nut
Terminals	solder terminals
Contact system	snap-action bridge contact
Contact function	latching
Contact arrangement	2 NC + 2 NO
Contact materials	Ag
Illumination	LED / filament lamp
Lamp socket	T 4.5

Mechanical characteristics

Operating force	3 ... 6.5 N
Operating travel	2.5 mm
Switching travel NC	1.8 mm
Switching travel NO	0.9 mm
Robustness max.	100 N

Electrical characteristics

Rated voltage AC max.	250 V
Rated voltage DC max.	230 V
Rated voltage AC/DC min.	12 V
Rated current AC max.	4 A
Rated current DC max.	0.2 A
Rated current AC/DC min.	5 mA
Contact resistance acc. to life max.	200 mΩ
Protection class	II
ESD-strength min.	14 kV

Other specifications

Operating life, at 250 V/2 A (operations)	200,000 (momentary), 50,000 (latching) cycle
Operating life, at 250 V/4 A (operations)	60,000 (momentary) cycle
Degree of protection from front side	IP65 (DIN EN 60529)
Operation temperature min.	-25 °C
Ambient temp. operating max. without lamp / LED	+70 °C
Ambient temp. operating max. with lamp /LED	+55 °C
Storage temperature min.	-40 °C
Storage temperature max.	+80 °C
Environmental resistance	acc. to IEC 60068-2-14, -30, -33 and -78
Weight	15 g
Hot wire ignition acc. to IEC 60695-2-1	yes
ROHS compliant	yes
REACH compliant	yes

Mounting hole

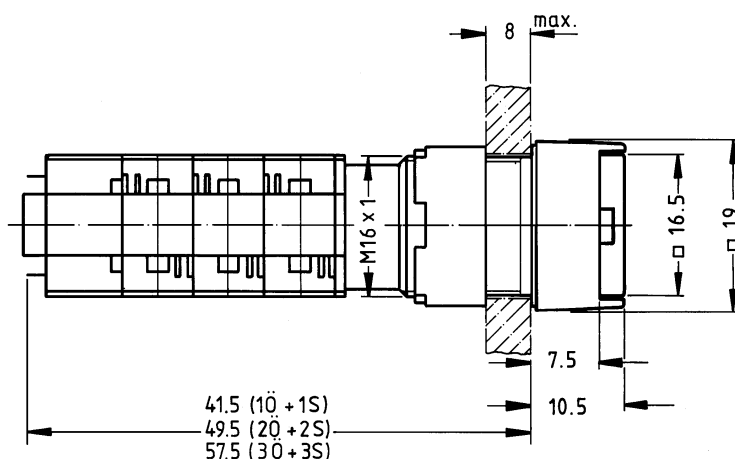
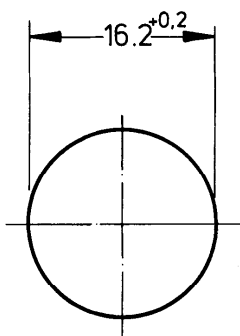

X-ON Electronics

Largest Supplier of Electrical and Electronic Components

Click to view similar products for [Pushbutton Switches](#) category:

Click to view products by [RAFI](#) manufacturer:

Other Similar products are found below :

[8940K2012](#) [LW1L-M1C10V-A](#) [LW1L-M1C70-A](#) [LW2L-A1C20M-GD](#) [LW2L-M1C20M-A](#) [60324L](#) [M22-D-R-GB0/K11](#) [M7E-HRN2](#)
[67021K512](#) [67081K512X](#) [701PB580](#) [7199K101](#) [810K12910](#) [810KSV30B](#) [MML21EA2ADK](#) [MML21KA3ABK](#) [MML23KA3AC05K-001](#)
[MML23KW3AA01W](#) [8418K2](#) [8442K3](#) [8450K1](#) [860K11911T01A](#) [861901](#) [861K11911T01A07](#) [861K13810T00A14](#) [861K13911](#)
[8646AB6X718UL](#) [8646ABUL](#) [9001KXRK](#) [907AYY100](#) [PMHD155A1](#) [9533CD4+U574+U4922](#) [95-414.000](#) [99-450.837](#) [99-453.837](#)
[PV3H2B0NN-341](#) [1203MRA](#) [A22NZBGANGA](#) [A22NZBNANGA](#) [A22NZMPATRA](#) [A2PMA1X03EC56](#) [A3A-5123-02](#) [A3A-7140](#) [A3A-7310](#) [A3A-7340](#) [A3U-TMW-A2C-5M](#) [A595](#) [12037A2ULCSA](#) [ABD122N-B](#) [1211390004](#)